

2-Loop Graphical Profile Controller & Recorder Concise Product Manual (59541-3) Page 1 of 6

A Full Product Manual is also available from your supplier.

The following symbols are used on the product labels:

	Caution: Potential danger to life or limb. Refer to installation manual when connecting		Equipment protected throughout by double insulation
	Alternating current		Both direct and alternating current

1. INSTALLATION

CAUTION: Installation should be only performed by technically competent personnel. It is the responsibility of the installing engineer to ensure that the configuration is safe. Local regulations regarding electrical installation & safety must be observed - e.g. US National Electrical Code (NEC) and/or Canadian Electrical Code. Impairment of protection will occur if the product is used in a manner not specified by the manufacturer.

Installing Plug-in Modules

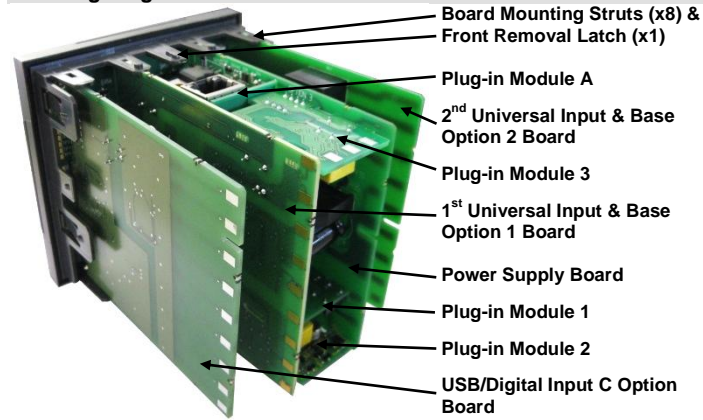

To access the plug-in modules, first remove the instrument from the housing.

- Pull front out to engage Front Latch. This prevents removal without a tool.
- Press latch with screwdriver through top vent hole. Remove front from case.
- Detach main boards by lifting first the upper, and lower mounting struts.
- Plug required modules into the correct connectors, as shown below.
- Locate the module tongues in corresponding slot(s) on the opposite board.
- Hold the Power and Input boards together while relocating on their mountings.
- Push the boards forward to ensure correct connection to the Display board.
- Replace the instrument by aligning the boards with the guides in the housing, then slowly push the instrument back into position.

NOTE: Plug-in modules are automatically detected at power up.

Main Board Connectors

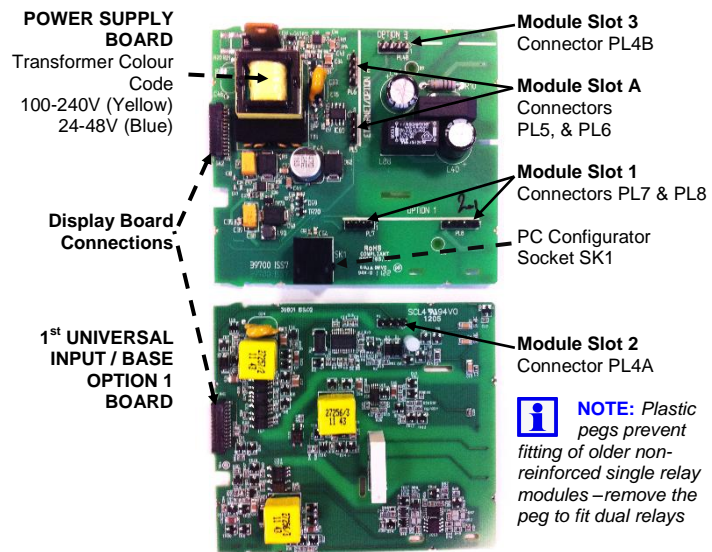

Re-fitting the Main Boards

This product is designed to allow the user to reconfigure some hardware options in the field by changing the modules fitted in slots 1, 2, 3, & A. The main boards (display/CPU, power supply, inputs 1 & 2 and digital input/USB) are factory fitted, but may be removed while reconfiguring the plug-in modules. Take care when re-fitting these boards. Observe the power supply board transformer colour, and case labelling to check the supply voltage, otherwise irreparable damage may occur.

CAUTION: In the event of a fault, replacement of defective main boards should only be carried out by trained personnel.

Panel Mounting

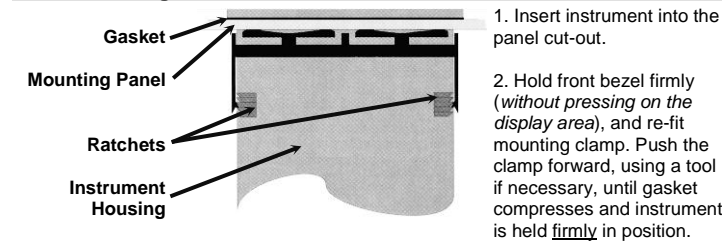

NOTE: For an effective IP66 seal against dust and moisture, ensure gasket is well compressed against the panel, with the 4 tongues located in the same ratchet slot.

Rear Terminal Wiring

CAUTION: The instrument is double insulated. All external circuits connected must provide double insulation. Failure to comply with the installation instructions may impact the protection provided by the unit.

CAUTION: Check correct operating voltage on the side label before connecting power. A UL listed anti-surge fuse should be fitted to the power input. An IEC60947-1 & IEC60947-3 compliant isolation switch should be fitted close to the unit, in easy reach of the operator, and appropriately marked.

NOTE: The wiring diagrams show all possible option combinations. The connections required depend on the options & modules fitted. Use single strand (1.2mm / AWG18 max size) copper wire, except for thermocouple inputs, where the correct thermocouple or compensating cable and connectors should be used.

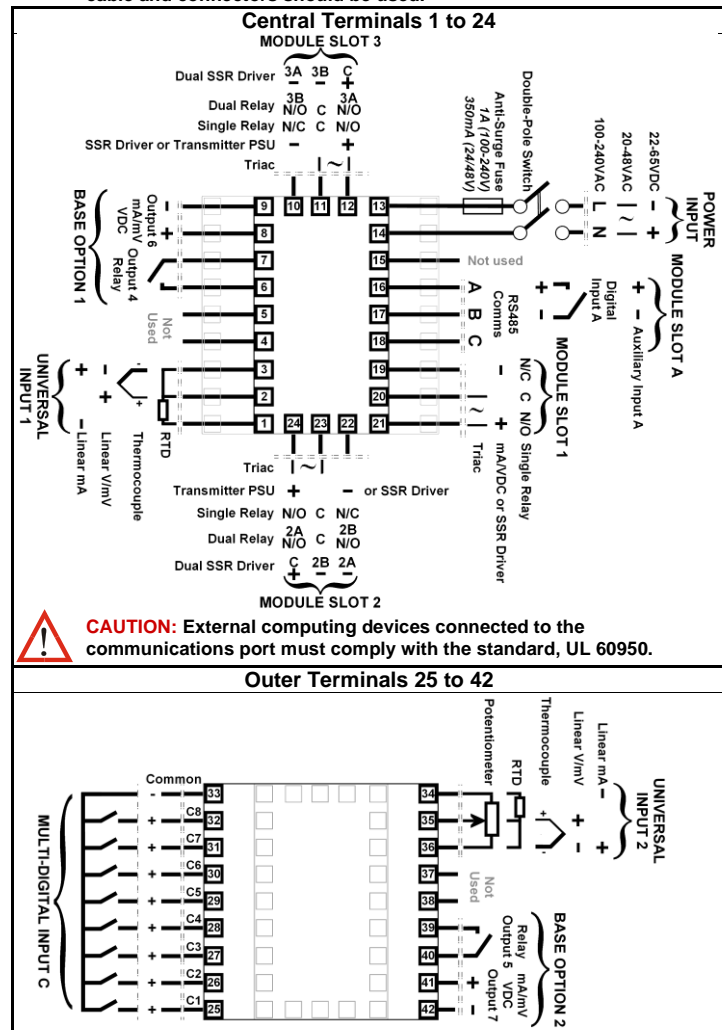

2. POWER UP SEQUENCE

Following the power-up self-test and logo screen, the instrument normally enters Operation Mode, from which the user can select the instrument's Main Menu (refer to the Screen Sequences on page 5). The exceptions to this are the first power-up after purchase where the Setup Wizard is shown, or if a plug-in module error is detected.

Plug-in Module Errors

If an invalid or unknown module is detected in one of the plug-in module slots the message "Fault Found, Press [F], for details" followed by "Replace faulty module in Module Slot n, Press [F]," (where n identifies the problem slot). The Service Contact information is displayed next showing details of who to contact if a fault persists

CAUTION: Do not continue using the product until the issue causing the error is resolved.

3. OPERATION MODE

This mode is entered at power on, or can be accessed from the Main Menu. The initial screens shown in operation mode vary depending on the options fitted and the configuration. Subsequent screens display and may allow the selection or adjustment* of Setpoints, setpoint ramps, enable/disable control, auto/manual operation, alarm status, profiler & recorder status and graphical trend views. Some screens will persist until the user navigates away, others will "time-out" back to the main screen (refer to **Operation Mode**: in Screen Sequences).

Press [F] or [M] briefly to move forward/back through parameters. Where adjustment is possible*, press [F] or [M] to alter the values. The next/previous screen follows the last parameter - or hold down [F] or [M] >1sec to skip straight to next/previous screen accepting ALL values shown.

* If required, all Operation Mode parameters can be made read only (see Display Configuration on page 6) and others may be removed from this mode altogether.

NOTE: Configuration must be completed before starting normal operations.

Single Control Loop: Normal Operation

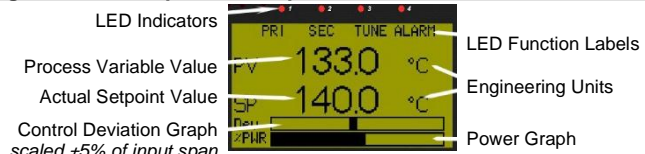

Single Control Loop: Profiler Status



If enabled in Display Configuration, the prior screen allows the user to Select, Run, Hold or Abort a profile. The next screen shows the profile event output status.

Two Control Loops: Normal Operation

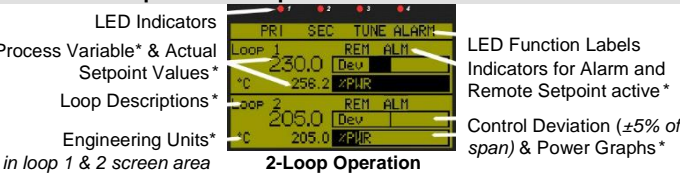

Two Control Loops: Profiler Status

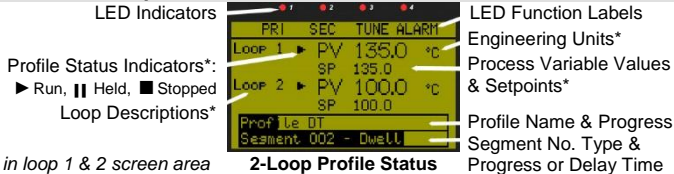

Cascade Control: Normal Operation

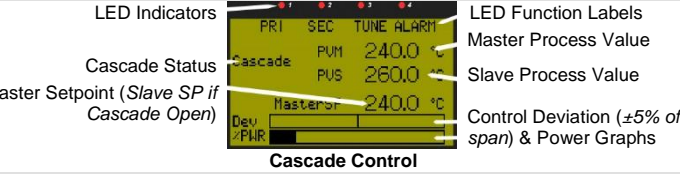

Ratio Control: Normal Operation

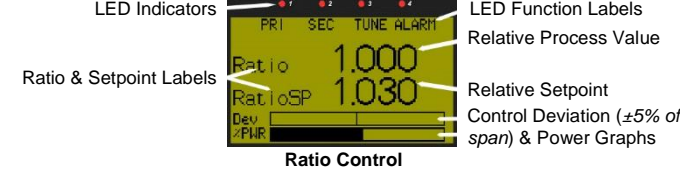

Trend Views

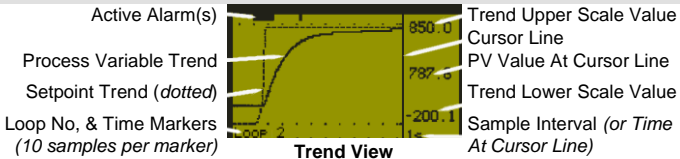

The Trend Views graph PV; PV & SP; or Max/Min PV between samples, plus active alarms. Graph format and sample intervals are set in Display Configuration. Trend scale values adjust automatically to visible data (between 2 to 100% of input span). 120 of 240 historical data points visible. Pressing [F] or [M] moves the Cursor Line back through the last 240 data points.

NOTE: Data is not retained at power down or if the sample interval is changed.

Manual Control

Depending on the Control Configuration settings, automatic or manual control can be selected from the Auto/Manual selection screen, or via a digital input. Switching to or from manual mode is via Bumpless Transfer.

In Manual mode the Setpoint display is replaced by a -100 to 100% power output level, labelled "Man".

Press [F] or [M] to set the required manual power.

When using VMD control, Manual mode replaces the Setpoint display with the valve movement status (Opening, Closing or Stopped), and is labelled "Man".

The [F] key opens the valve and the [M] key closes the valve.

If Manual control is selected when in Cascade mode, the slave loops % power value is shown. This is the power output fed directly to the control actuator (e.g. heaters).

NOTE: Selecting Manual Control will cause a running profile to hold until control is returned to automatic mode.

CAUTION: Manual mode overrides the automatic control loop. It also ignores any output power limits, valve open/close limits and the control enable/disable setting. The operator is responsible for maintaining the process within safe limits.

Over/Under Range & Input Fail Indications

If the process or auxiliary inputs are >5% above or below the scale max/min, the displayed value is replaced with the word "HIGH" or "LOW".

If a signal break is detected, the value is replaced with "OPEN"; except in Ratio control where an open input 1 or 2 is shown as "x1-Open" or "x2-Open". An un-calibrated input is replaced by "ERROR".

In OPEN or ERROR conditions, the Control Outputs go to the pre-set power value (see Control Configuration on page 6).

CAUTION: Correct the problem causing the error condition before continuing normal operation.

Customising Operator Mode

The user can choose to enable or disable some operator mode screens from the Display Configuration menu (see page 6). These are: cascade mode switching; auto/manual control selection; setpoint ramp-rate values; selecting the setpoint source; control enable/disable; clear latched outputs; manually triggering a recording; recorder status information and trend views - these are marked [F] in the screen list on page 5 to indicate that they are optional.

In addition, up to 50 configuration mode parameters can be copied into operation mode using the PC software. Any parameters selected in this way are shown at the end of the normal operator mode screen sequence.

NOTE: Configuration mode parameters copied into operation mode are not pass code protected.

It is recommended that you only enable operator mode screens if they are important for daily operation. Consider using Supervisor Mode (see section 2.1) for parameters that the operator may need less often or that you want to limit access to.

4. AUTOMATIC TUNING

To automatically optimise the PID tuning (PI tuning in VMD mode) for the process, you can use Pre-Tune, Self-Tune or Auto Pre-Tune independently for each loop.

Pre-tune performs a single start-up disturbance test. It stops running when the test has completed. The user chooses which PID set the new tuning terms will be applied to, and this selection does not change the selected "active PID set". There are two modes; Standard Pre-Tune which tests the process response half-way from the activation point (the process value when pre-tune began running) to the current setpoint; or Pre-Tune at Value which allows the user to specify the exact process value at which the test will occur.

CAUTION: Consider possible process over-shoot when selecting the value to tune at. If there is a risk of damage to the product or equipment select a safe value.

If Auto Pre-Tune is selected, a Standard Pre-tune will attempt to run at every power up. If Self-Tune is selected it constantly monitors the process and adjusts the tuning when control errors occur. Auto pre-tune and self-tune apply the new tuning terms to the current Active PID set. Auto pre-tune and self-tune are not possible with cascade.

NOTE: To pre-tune a cascade, first select "Cascade-Open" to tune the PID set(s) on the slave. After the slave has successfully tuned, remember to pre-tune the master/slave combination (this time select "Cascade-Closed"). The cascade remains open until you do this.

See PID Sets & Gain Scheduling on this page and Automatic Tuning on page 5. Refer to the Full Product Manual (from your supplier) for more about tuning.

NOTE: Automatic tuning will not engage if either proportional band is set to On/Off control. Also, pre-tune (including and auto pre-tune attempt) will not engage if the setpoint is ramping, a profile is running, or the Process Variable is <5% of span from setpoint.

5. PID SETS & GAIN SCHEDULING

Up to 5 sets of PID tuning terms (primary & secondary proportional bands or on-off differential, integral & derivative times, overlap/deadband) can be entered for each control loop, allowing the unit to be pre-set for differing conditions. For each loop one set can be selected as the "Active PID" set, or alternatively, if the process conditions change significantly during use (e.g. if it is partially exothermic as the temperature rises) Gain Scheduling can be employed.

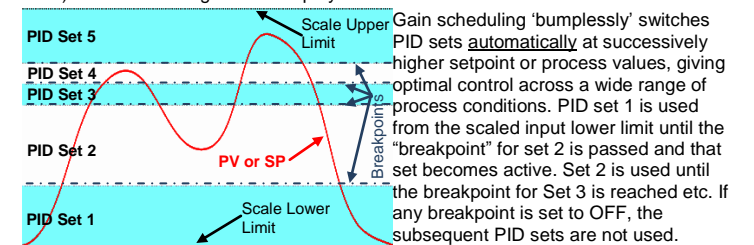

See Automatic Tuning section 4 for tuning the PID sets.

NOTE: ON/OFF control is possible with the individual PID sets but cannot be used with gain scheduling. On/off control is replaced with the default proportional band if gain scheduling is turned on.

6. APPLICATION SETUP

Setup Wizard

An easy **Setup Wizard** runs automatically at first ever power-up. Follow the wizard to setup parameters required for **basic** applications. The screens/parameters marked "w" in the Screen Sequences lists are included, see pages 5 & 6. The wizard can be run again at any time from the main menu. An option to reset **all** parameters to default (*recommended*) is offered when manually running the wizard.

Pre-commissioning Considerations

The next sections provide guidance for more complex applications where the wizard is not sufficient. It is important to understand how the instrument is to be used before commencing with the setup. Consideration must be given to the following questions:

If fitted, how will the 2nd input be used?

- One loop only (2nd input not used in this application)
- Two independent control loops.
- Valve feedback for loop 1
- A "redundant" backup for the 1st input (see section 10).
- Cascaded with the first control loop (see section 7).
- A reference input for ratio control (see section 8).

How will the instrument control the process?

- Primary only or primary & secondary control outputs (see section 12).
- Direct valve motor drive outputs (see section 11).

The table below shows the main input and control configuration settings for these application types (see page 6 for the configuration menus).

Process Type* (only if 2nd input fitted)	Loop 1 / Master Control Configuration: Control Select	Control Configuration: Control Type	Loop 2 / Slave Control Configuration: Control Select	Control Configuration: Control Type
One Loop*	Standard PID	Primary Only		
Input 2 Configuration Input 2 Usage = Not Used	Control Select = Control Standard	Control Type = Single		
		Primary / Secondary Control Type = Dual		
		Valve Motor Drive Control Select = VMD (TPSC)		
		Control		
Two Loops*	Standard PID	Primary Only	Standard PID	Primary Only
Input 2 Configuration Input 2 Usage = Standard	Control Select = Control Standard	Control Type = Single	Control Select = Control Standard	Control Type = Single
		Primary / Secondary Control Type = Dual		Primary / Secondary Control Type = Dual
		Valve Motor Drive Control Select = VMD (TPSC)		Valve Motor Drive Control Select = VMD (TPSC)
		Control		Control
+Feedback*	Valve Motor Drive			
Input 2 Configuration Input 2 Usage = Feedback	Control Select = VMD (TPSC)			
	Control			
Redundant*	Standard PID	Primary Only		
Input 2 Configuration Input 2 Usage = Redundant Input	Control Select = Control Standard	Control Type = Single		
		Primary / Secondary Control Type = Dual		
		Valve Motor Drive Control Select = VMD (TPSC)		
		Control		
Cascade*	Standard PID	Primary Only	Standard PID	Primary Only
Input 2 Configuration Input 2 Usage = Standard AND Loop 1 / Master Configuration Control Mode = Cascade	Control Select = Control Standard	Control Type = Single	Control Select = Control Standard	Control Type = Single
		Primary / Secondary Control Type = Dual		Primary / Secondary Control Type = Dual
		Valve Motor Drive Control Select = VMD (TPSC)		Valve Motor Drive Control Select = VMD (TPSC)
		Control		Control
Ratio*	Standard PID			
Input 2 Configuration Input 2 Usage = Standard AND Loop 1 / Master Configuration Control Mode = Ratio	Control Select = Control Standard			
		Valve Motor Drive Control Select = VMD (TPSC)		
		Control		

Which outputs will be used for control, and are alarms or event outputs needed?

- Output configuration (see page 6).
- Alarms & Profile Events (see pages 5 & 6).

Where will the controller setpoint come from?

- Local setpoint(s) only, or a remote setpoint input (see page 6).
- Profile Control (see section 15).

Is Input re-configuration required:

- Analogue input calibration & scaling (see section 13).
- Digital input functions (see section 9).

Which other features are to be used?

- Data Recorder (see section 17).
- Serial Communications (see section 19).
- USB Interface (see section 16).

CAUTION: Configuration & commissioning must be completed before proceeding to Operation Mode. It is the responsibility of the installing engineer to ensure that the configuration is safe.

7. CASCADE CONTROL MODE

Applications with long time lags (e.g. with two or more capacities such as heated jackets) can be difficult to control with a single control loop. The solution is to split the process into two or more cascaded loops consisting of a Master and Slave(s) acting on a common actuator. Ideally, the slave loop's natural response time should be at least 5 times faster than the master.

The master loop compares the process temperature with the desired setpoint and its correcting variable (0 to 100% PID output) becomes the slave loops effective setpoint (scaled to suit the process). This setpoint is compared to the slave's process input, and the controlling actuator is adjusted accordingly.

NOTE: Cascade control is available on models fitted with the 2nd Universal Input. The master connects to input 1; the slave to input 2.

Example

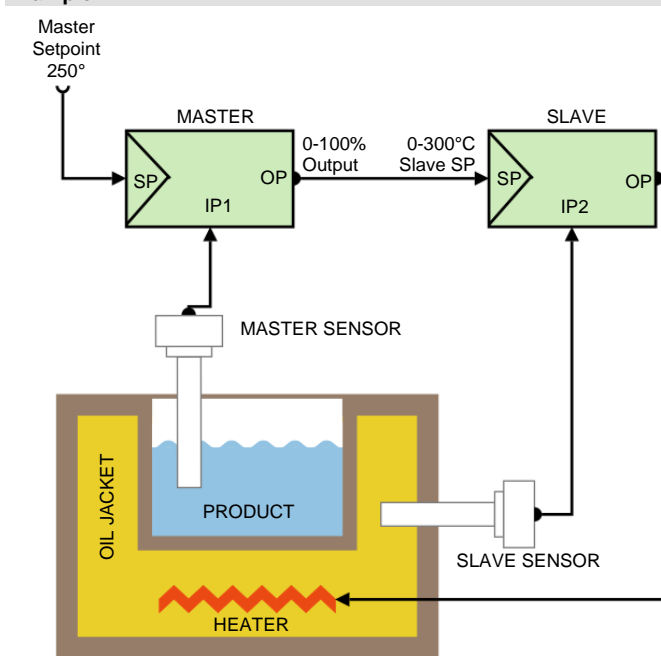

In this example the controlling actuator is a heater, indirectly heating the product via an oil jacket. The maximum input to the slave represents 300°C, thus restricting the jacket temperature. At start-up the master compares the product temperature (ambient) to its setpoint (250°C) and gives 100%. This sets the maximum slave setpoint (300°C), which is compared to the oil temperature (ambient) and the slave requests maximum heater output.

As the oil temperature rises towards the slave setpoint, its output falls. Eventually, the product temperature will also begin rising, at a rate dependant on the transfer lag between the oil jacket and the product. This causes the master's PID output to decrease, reducing the slave setpoint. The oil temperature is reduced towards the new slave setpoint. This continues until the system becomes balanced. The result is quicker, smoother control with the ability to cope with changes in the load. Overshoot is minimised and the jacket temperature is kept within acceptable limits.

Cascade Operation

During operation, the master and slave are coupled together and "Cascade" is displayed. The master process value and setpoint are most relevant to the user. This setpoint is directly adjustable, and the process value of the slave controller is displayed for information only.

Normal Cascade Operation

The cascade can be disconnected (via digital inputs or menu selection), switching from normal operation to direct control of the slave. "Cascade-Open" is displayed. The process is then controlled and adjusted solely by the slave controller using its internal setpoint (displayed as **SlaveSP**). Switching back to Cascade is "Bumpless".

Cascade-Open

The cascade can be disconnected (via digital inputs or menu selection), switching from normal operation to direct control of the slave. "Cascade-Open" is displayed. The process is then controlled and adjusted solely by the slave controller using its internal setpoint (displayed as **SlaveSP**). Switching back to Cascade is "Bumpless".

CAUTION: The master process value is not under control when the cascade is open, but will be affected by the slave process. The operator is responsible for maintaining safe conditions.

Manual Mode

The controller can be put into manual mode (via digital inputs or menu selection), bypassing the cascade to take direct control of the slave loop's correcting variable. Manual power is adjusted from -100 to 100%. "MAN" is displayed in manual mode.

CAUTION: Manual mode disables the cascade loop. It also ignores any output power limits, valve open/close limits and the control enable/disable setting. The operator is responsible for maintaining the process within safe limits.

Cascade Tuning

The user can tune manually or use the pre-tune feature (see Automatic Tuning). In either case the slave control loop must first be optimised on its own, followed by the master loop in combination with the **previously tuned** slave.

To pre-tune a cascade:

1. Go to the Automatic Tuning menu
2. Select "Cascade-Open" to tune the PID set(s) on the slave.
3. After the slave has successfully tuned, pre-tune the master/slave combination (this time select "Cascade-Closed"). **The cascade remains open until you do this.**

To manually tune a cascade:

1. Open the cascade, breaking the link from master to slave.
2. Set the slave controller setpoint manually to an appropriate value.
3. Tune the slave for relatively fast control ('proportional only' is often sufficient).
4. Close the cascade and tune the master/slave combination.

8. RATIO CONTROL MODE

A ratio control loop is used where the quantity of one of the material is to be controlled in proportion to the measured quantity of a second material. The controller mixes the materials at the desired ratio by adjusting the flow of input 1. The flow of input 2 may be controlled separately, but is not controlled by this loop. The process value used by the controller is therefore determined by the ratio of the two inputs rather than being measured as one process variable.

NOTE: Ratio control is available on models fitted with the 2nd Universal Input. Connect the Air flow to input 1 and the fuel to input 2.

Stoichiometric combustion

Below is an example of standard ratio control using stoichiometric combustion. For optimum combustion the fuel-air ratio must be controlled. The ratio is selected so that there are no inflammable residues in the waste gas.

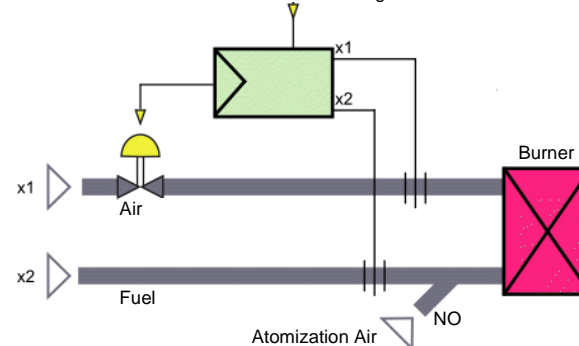

It is normal in this application to display the process value and setpoint as relative values rather than the physical ratio or absolute values. A scaling factor is set such that the displayed value will be 1.00 at the correct stoichiometric ratio for the application.

Inputs 1 and 2 are configured and scaled to match the attached flow meters. In this example a 4 to 20mA signal at x1 represents 0 to 1000m³/h of airflow controlled by a valve. The second 4 to 20mA signal at x2 represents 0 to 100m³/h of fuel oil. The fuel flow is not affected by this control loop. Atomizing air is fed in with the fuel oil at a constant rate 'NO'. This must be considered when calculating the correct fuel/air mix. Total airflow is x1 + NO. The stoichiometric factor, *SFac* is entered to match the desired ratio. E.g for 10 parts total airflow to one part fuel, *SFac* would be 10.

The setpoint (entered as a relative value such as 1.00) is multiplied by *SFac* when calculating the control deviation. E.g. with a setpoint of 1.00 and *SFac* of 10 the controller attempts to make the physical ratio 10. With a setpoint of 1.03 it would attempt to make the ratio 10.3 for 3% excess air.

The instantaneous (controlled) process value is calculated from the physical ratio, divided by *SFac*. Like the setpoint, this is displayed as relative value. E.g. if *SFac* is 10, 59.5m³/h air is measured at x1, 0.5m³/h atomising air is applied at NO and 6m³/h fuel is measured at x2, the instantaneous process value would be:

$$\frac{x1 + NO}{x2 * SFac} = \frac{59.5 + 0.5}{6 * 10} = 1.00$$

9. DIGITAL INPUTS

Digital inputs are driven to one of two states (active or inactive) by an applied voltage signal or a contact opening/closing. They can be used for profile selection (see *Digital Input Setup sub-menu on page 6*), with any remaining inputs available for functions such as selecting setpoint sources, running a profile or driving an output on/off (the *Digital Input Specifications on page 4 lists all possible functions*).

A diagnostic screen assists commissioning and fault finding by showing the current signal state for all digital inputs.

Slot A, C1 to C8 & Soft digital input status (☑ = Active, ☐ = Unavailable)
Profile select bit format (BCD or Binary)
Profile selected (e.g. BCD 6 from C1-C3)

Digital inputs can be inverted to reverse their action with an "on" input turning off. Step through each input using the **↻** key. Press **↻** to invert **☑** the highlighted input and **☐** to un-invert **☐**. Hold **↻** down to skip to next screen accepting the values shown.

Highlighted Input

Four "soft" digital inputs can be configured by combining physical inputs, alarms & events using Boolean logic. The input AND selections are globally OR'd with input OR selections, alarms & events. By using the invert inputs function, NAND & NOR equivalents can be created.

Soft inputs and any physical digital inputs not allocated for profile selection can be used to change the instrument status. Functions include: Setpoint or Auto/man select; control on/off; automatic tuning; clearing latched outputs; profile control; data recording; forcing outputs on/off or mimicking key presses.

10. REDUNDANT INPUT

If the 2nd universal input is fitted, it can be used with a backup sensor so that if the main sensor fails, the instrument automatically switches to the redundant sensor. In this condition, if input 1 has a signal break alarm configured it will activate, but any other process input or control status alarms seamlessly switch to the 2nd input. This input continues to be used until the signal to input 1 is restored. The user may not even be aware of the sensor fault, so signal break alarms should be configured for both inputs to provide notification.

The redundant sensor must be of the same type, and be correctly located in the application ready to take over if needed. If this option is selected, the 2nd input cannot be used for other functions.

NOTE: If both signals are lost at the same time, the PV is replaced with "OPEN" and the normal sensor break actions occur.

11. VALVE MOTOR / 3-POINT STEPPING CONTROL

When **directly** controlling motorised modulating valves, set the Control Mode to VMD in configuration mode to enable the 3-point stepping Valve Motor Drive control algorithm. This provides switched outputs to move the valve further open, or further closed when a control deviation error is detected. If the error is reduced to zero no further output is required until the load conditions change.

NOTE: Some modulating valves have positioning circuitry to adjust the valve position. These need a DC linear mA or voltage output and use the standard control algorithm (Set Control Mode to Standard). VMD doesn't allow On-Off Control (Prob. Band minimum is 0.5% of input span) and usually requires PI control, where the Derivative parameter is turned OFF.

Special Wiring Considerations for Valve Motor Control

Valve Motor Drive (VMD) mode requires two identical outputs to be assigned to position the valve. One to Open and one to Close the valve. These outputs can be two single relays, two triacs, two SSR drivers or one dual relay, but it is recommended to use two single relays (SPDT change-over contacts), and to interlock the wiring as shown. This prevents both motor windings from being driven at the same time, even under fault conditions.

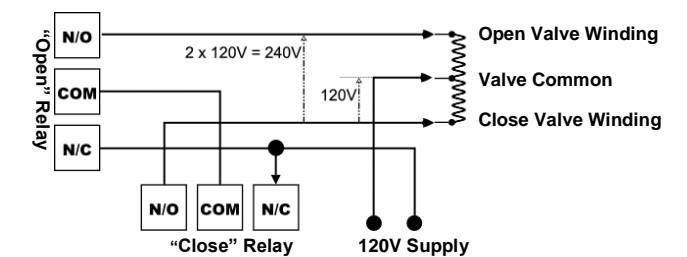

CAUTION: The windings of a valve motor effectively form an autotransformer. This causes a voltage doubling effect when power is applied to either the Open or Close terminal, causing twice the supplied voltage at the other terminal.

Switching actuators directly connected to the valve motor must only be used up to half of their rated voltage. The internal relay and triac outputs are rated at 240VAC. Therefore, the maximum motor voltage when using them is therefore 120V unless interposing relays are used. Interposing relays or other devices used to control the valve must themselves be rated for twice the motor supply voltage.

Position Feedback

The VMD mode in this instrument uses a boundless, open-loop, algorithm. It does not require any kind of position feedback in order to correctly control the process and can therefore avoid problems associated with faulty feedback signals. However, where feedback is available it can still be displayed as a percentage (0 to 100%) of the possible valve opening.

Valve Position Feedback is usually provided by means of a potentiometer mechanically linked to the valve. The output of a related flow meter can also be used to indicate the relative valve position. Flow meters typically have linear 0-20/4-20mA or 0-5/0-10V signals. To display the position/flow signal the 2nd input is must be configured for this purpose. The input is adjusted and scaled to read 0 to 100% for valve fully closed to fully open or for the flow rate equating to fully closed and open.

Valve Limiting

When Valve Position Indication is to be used the signal can be used by the instrument to limit the valve movement. Valve limits can be set beyond which the controller will not attempt to drive the valve.

CAUTION: These limits must be used with care. They are effectively control power limits. Do not set values that prevent proper control of the process!

12. CONTROL TYPE

The control type defines if a control loop has single (unidirectional) or dual (bidirectional) control outputs. Single control has a primary output only. This can drive the process in one direction (e.g. heating only, cooling only, increasing humidity etc). Dual control has both primary and secondary outputs which can force the process to increase or decrease (e.g. heating & cooling, humidifying & dehumidifying etc). This selection isn't required for VMD control which provides direct 3-point stepping control for valves, and always has one output to increase and another to decrease the process value (see section 11).

13. INPUT CALIBRATION & SCALING

The process inputs can be adjusted to match the characteristics of the attached process or to remove sensor errors. For each loop, independent use of base (unadjusted), single point offset or two point calibration strategies are possible, as is the use of multi-point scaling for the displayed values.

CAUTION: Calibration & Scaling must be used with care. Careless use could lead to the displayed value bearing no meaningful relationship to the actual process variable. There is no front panel indication of when these parameters are in use.

NOTE: These methods do not alter the internal instrument calibration. Simply choose Base Calibration to restore normal measured values. Re-calibration of the internal base values is possible, but should only be attempted by qualified personnel as it overwrites the factory calibration - refer to the Full Product Manual if this is required.

Single Point Calibration

This is a 'zero offset' applied to the process variable across the entire span. Positive values are added to the reading, negative values are subtracted. It can be used if the error is constant across the range, or the user is only interested in a single critical value. Simply enter a value equal, but opposite to the observed error.

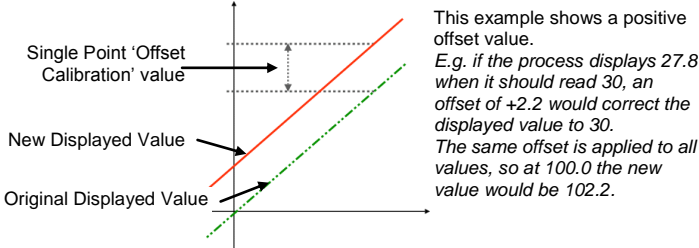

Two Point Calibration

This method is used where an error is not constant across the range. Separate offsets are applied at two points in the range to eliminate both zero and span errors. Measure the error at a low point in the process, and again at a high point. In the Input Calibration, enter the desired low point as the Calibration Low PV value, and an equal, but opposite value to the observed error as the Calibration Low Offset. Repeat this for the high point PV and calibration offset in the next screen.

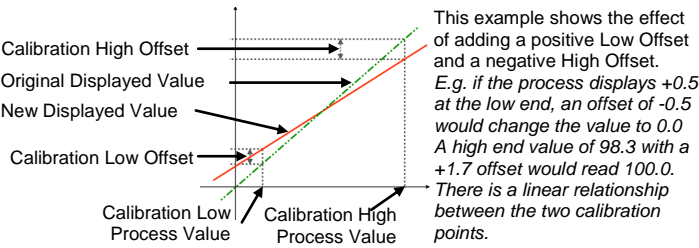

NOTE: Choose values as near as possible to the bottom and top of your usable span to achieve maximum calibration accuracy. The effect of any error can grow past the chosen calibration points.

Multi-point Scaling

If an input is connected to a linear signal (mA, mV or VDC), multi-point scaling can be enabled for that input from the Input Configuration sub-menu, so that a non-linear signal can be linearized. The scaled input upper & lower limits define the values shown when the input is at minimum and maximum values. Up to 15 breakpoints can scale the input vs. displayed value between these limits. Enter the 1st Scaling point (this is a % of the scaled input span), and the desired display value to be shown at that input value. Next set the 2nd point and display value, followed by the 3rd etc. Continue until all breakpoints are used or you have reached 100% of the input span. A breakpoint set at 100% ends the sequence. It is advisable to concentrate the break points in the area of the range with the most non-linearity, or an area of particular importance to the application.

14. SETPOINT SOURCES

The setpoint is the target value at which the instrument attempts to maintain the process variable. Each loop can have a Main "local" setpoint set from the keypad and Alternate setpoint. The alternate setpoint sources can be either another local setpoint or a remote setpoint (RSP), set by a mA or V DC signal fed to the auxiliary or 2nd process input. The controller can only use one setpoint source at a time for each loop. This is called the "Active Setpoint".

Main/alternate setpoint selection can be made via a digital input; from Control Configuration or if enabled in Display Configuration, an operator menu can be used to select the setpoint.

Refer to the control configuration screen on page 6 for setpoint settings.

NOTE: In profile control mode, the selected profile provides the active setpoint source for one or both control loops (see section 15). Once profile control mode is exited, the selected Main or Alternate setpoints become active again.

15. PROFILER OPTION

The Profiler (or setpoint programmer) feature allows the user to store up to 255 profile segments (each with the possibility of 2 setpoints in two-loop control), shared between a maximum of 64 Profiles. Each profile controls the value of the setpoint(s) over time; increasing, decreasing or holding their values as required.

NOTE: If this feature is fitted, Profiler options are added to the Main Menu, and optionally to Operation Mode. See sections 3 & 20.

Profiler Enabling

Controllers supplied without the Profiler option can be upgraded in the field by purchasing a licence code. To obtain the correct code you must tell your supplier the instrument serial number - this can be found in Service & Product Information. To enter this code, hold down the **Q** + **0** keys during the power-up splash screen.

Enter the 16-character licence code in the displayed screen, then press **0**. To confirm if profiling is installed, refer to Service & Product Information.

General Profile Configuration

General profile configuration settings apply to all profiles. They enable/disable profile editing while running, and automatic starting of profiles that were setup with delay or day & time start triggers. When disabled profiles can only be manually started, and this is with immediate effect even if they have a delay or day & time trigger defined. When enabled, delayed starts are possible, and if the selected profile has a day & time trigger it will wait and then start at the time set.

Profile Header & Segment Information

Each profile has its own header information plus 1 or more segments. The header contains the profiles name; if it is to control one or both loops; how it should start & stop; abort/power-loss recovery actions and if it should repeat. Segments can be ramps, dwells, steps or special segments such as holds, ends, joins or loop backs.

NOTE: Header information is only stored as the Segment creation sequence begins. No profile is created if you exit before this point. Segment information is stored as each segment is created, but the profile remains invalid until an end or join segment is defined.

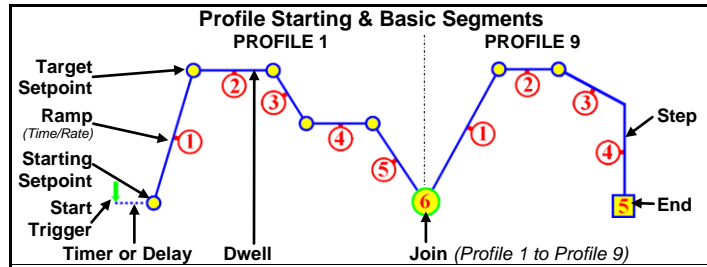

Following a Start Trigger, profiles can start immediately, or if enabled after a delay, or at a specified day & time (Recorder only).

NOTE: Profiles with segments outside of the current setpoint limits will not run. A "profile not valid" error shows.

Segments have an end of segment Target Setpoint. If the 1st segment is a Ramp-Time, the slope needed to reach the target changes with the Starting Setpoint value. For a Ramp-Rate segment, the time will change instead. A Dwell (or "soak") holds the last segments value. Step segments jump straight to the target value. Segments in two-loop controllers control the setpoints of both loops.

NOTE: If the last segment is a Join, the join target profile will start, but if the join target has been deleted the profile sequence will abort. An End segment ends the profile or sequence of joined profiles.

2-Loop Profiles

If required, the setpoint of both control loops can be maintained when profiling. The example to the right shows how this works. Auto-Hold settings and target setpoints are independent for each loop, but the segment types and time settings are the same. Seg. ① & ② shows a ramp and a dwell with the shared time base. Both loops on same time-base

The ramp direction can be different (Seg. ③), and although one loop cannot ramp while the other dwells, a "dwell" is achieved by a ramp with its final setpoint value at the same value as the previous segment (Seg. ④). Similarly, if only one loop is to Step to a new value, make the other "step" to its existing setpoint value. If you later change the previous setpoint, you may have to change both segments. The Loop-back feature takes both loops back to the previous segment. Ramp-Rate segments are not possible with 2-loop profiling.

NOTE: Either loop can cause the profile to auto-hold. The profile continues only when both loops are back within their hold bands.

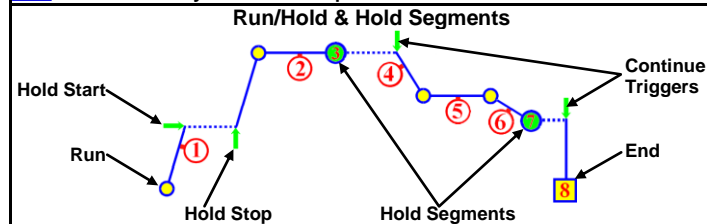

A Hold condition during a segment maintains the current setpoint value of both loops. Once the hold is stopped the Ramp or Dwell continues.

NOTE: A running segment will hold if the operator or a digital input instructs it to, during "auto-hold", if one of the profile control loops is disabled, if a cascade is set to "open" or if manual control is selected.

A Hold Segment maintains the value of the last segment. The profile does not continue until a Continue Trigger occurs. This can be via a key press, a digital input signal or after waiting for a time of day (Recorder only).

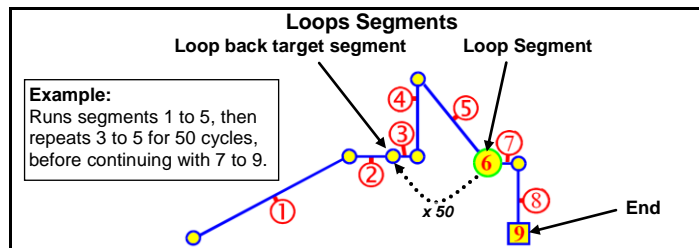

A Loop Segment goes back to a specified segment. This action is repeated for the required number of times (1 to 9999) before the profile continues onwards. More than one Loop Segment can be used, but they must not cross.

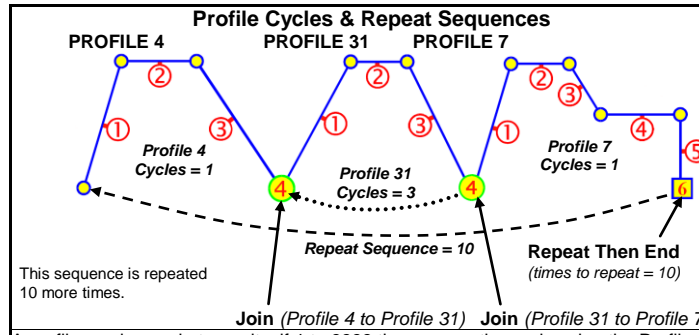

A profile can be made to run itself 1 to 9999 times or continuously using the Profile Cycles setting. A profile ending with Repeat Then End will run the entire sequence of profiles again 1 to 9999 times or continuously.

Auto-Hold

Each segment has independent Auto-Hold settings. If used, these ensure process and profile remain synchronised. If the process does not closely match the setpoint, the profile can be held until it returns within bounds. The segment time is increased by the time that the process is out of bounds. When Auto-Hold is active the profile status is shown as Held. The user can choose to hold the profile if the process beyond the Hold Band Above only, Below only or Band (either side of the setpoint). 2-loop profiling has individual Auto-Hold settings for the two loops. The entire profile (i.e. both loops) will be held if either process is outside of its Auto-Hold Band.

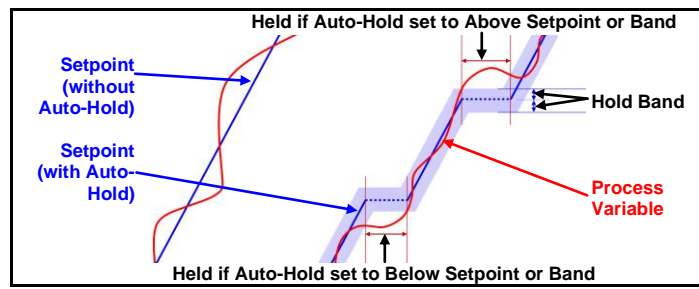
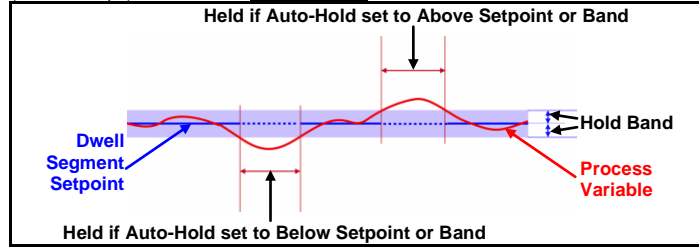

End, Abort and Power/Signal Lost Recovery

If the power is cut or the input is lost (either signal for 2-loop profiling) while a profile is running, the instrument will use the defined Profile Recovery Method once the signal / power returns. These options are explained below.

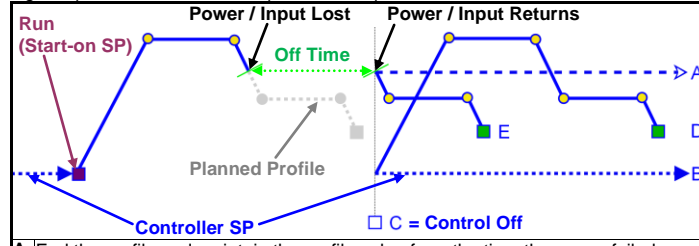

A End the profile and maintain the profile value from the time the power failed.
B End the profile and use Controller Setpoint value.
C End the profile with the control outputs off - setpoint value display says "OFF"
D Restart the profile again from the beginning.
E Continue profile from the point it had reached when the power failed

On Recorder versions, option E will always be used if the power / signal is lost for less than the Profile Recovery Time. If the power / signal is lost for more than this time the defined Profile Recovery Method is used.

Similar options are offered for the Profile End Action taken at the normal profile end, or for the Profile Abort Action if the profile is force to end before it is finished. These can be defined to act in a similar manner as A, B or C above

16. THE USB INTERFACE

The USB Interface can be used to upload or download instrument settings to or from a USB memory stick. It allows easy configuration of multiple instruments or the transfer of settings to/from the PC configuration software.

If the Data Recorder or Profiler options are fitted, recordings and profile information can also be transferred via USB memory stick.

NOTE: If this feature is fitted, a USB Menu option is added to the Main Menu. See USB Port information in section 20.

USB Memory Stick Folders & Files

When a USB stick is inserted, the instrument looks for, and if necessary creates the DEVICE, CONFIG, PROFILE and RECORDER folders. Files must be located in these folders in order to be used. When preparing to upload files from your PC, ensure that you save them to the correct folder on the memory stick.

NOTE: To speed up the disk operation, keep the number of files stored in these folders to a minimum.

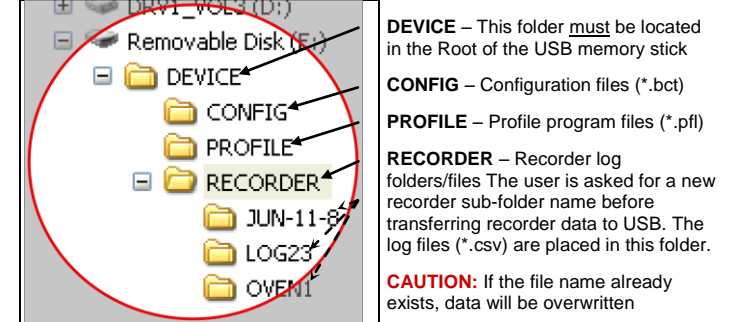

CAUTION: Do not remove the memory stick from the USB port whilst a data transfer operation is in progress. Data loss or corruption may result.

The first recorder log file is named 001-0001.csv. A new file is created with the first 3 digits incremented (e.g. 002-0001.csv; 003-0001.csv etc) each time the data being recorded is changed. The last 4 digits increment (e.g. 001-0002.csv; 001-0003.csv etc) if the file size reaches 65535 lines, or if recording is re-started after being stopped for >2x the recording sample rate.

CAUTION: During Data Transfer, normal operation carries on in the background, but operator access to other screens is not possible. Transfer of full memory can take up to 20 minutes. Only begin a transfer when access (e.g. setpoint changes) will not be required.

17. DATA RECORDER

This option can record the process conditions to memory over time. It operates independently from the Trend Views.

NOTE: If fitted, Recorder options are added to the Configuration and Main Menus. Recorder Control can also be added to Operation Mode. See Data Recorder information in section 20.

CAUTION: This feature includes a battery backed Real Time Clock (RTC). Servicing and replacement of the internal lithium battery should only be carried out by a trained technician.

The RTC also expands the profiling capabilities and allows a "calibration due" reminder at a specified date. See page 5 for Profile Setup, & page 6 - Input Configuration; for the calibration reminder, and Clock Configuration for RTC settings.

Recorded Data

For each control loop, a combination of values can be recorded at each sample, selected from: Process Variable; Maximum or Minimum PV (since the previous sample); Setpoint; Primary Power, Secondary Power or Auxiliary Input values. Additionally the status of Alarms and Profiler Events can be recorded, as can when the unit is turned On/Off.

NOTE: If Alarm or Events are selected, change of state is recorded. This uses extra memory, reducing the remaining recording time.

Sample rates between 1 second and 30 minutes are possible, with the data recorded until the memory is full, or continuous First In/First Out memory overwriting the oldest data with new. See Recorder Configuration on Page 6 for more details.

Recorder Triggers

Options for starting/stopping recordings include Manually (from the recorder menu or a screen added to operation mode); a Digital Input; during a Running Profile; or Record on Alarm. Any active trigger that has been configured will cause the recorder to run. The recorder status screen has a % memory used bar graph and icons for the active record triggers.



Downloading Recordings

Recordings can be transferred to a memory stick using the USB Port or downloaded to the PC software via the configuration port or serial communications if fitted. Recordings are stored in Comma Separated format (.csv) which can be opened and analysed with the optional PC software. The recorded data files can also be opened directly into a spreadsheet, or imported into other software. See Section 16 Error! Reference source not found. for file information.

NOTE: Analysis with the PC software is limited to 8 analogue channels, so only the first 8 will be displayed. The number of recorded alarms & event channels is not limited.

Calibration Reminder

The recorders RTC allows a "calibration due reminder" to be shown if the date is equal to or after the Calibration Reminder Date. The reminder screen persists until the **0** key is pressed. If due, the reminder is shown at Power-up, and repeated every 24hrs until the reminder date is changed. See Input Configuration: for the calibration reminder settings.

2-Loop Graphical Profile Controller & Recorder Concise Product Manual (59541-3) Page 4 of 6

18. SPECIFICATIONS

Sampling Rate: 10 per second.
Resolution: 16 bits. Always four times better than display resolution.
Impedance: >10MΩ resistive, except DC mA (5Ω) and V (47kΩ).
Temp Stability: Error <0.01% of span per °C change in ambient temperature.
Supply Variation: Supply voltage influence negligible within supply limits.
Humidity Influence: Negligible if non-condensing.
Process Display: Displays up to 5% over and 5% under span limits.
User Calibration: Single or two point. +ve values added to Process Variable, -ve values subtracted from Process Variable

Sensor Break Detection: Thermocouple & RTD - Control goes to pre-set power value. High & Sensor Break alarms activate. Linear (4 to 20mA, 2 to 10V and 1 to 5V only) - Control goes to pre-set power value. Low & Sensor Break alarms activate. Reinforced safety isolation from outputs and other inputs.

Type	Range °C	Range °F
B	+100 to 1824°C	+211 to 3315°F
C	0 to 2320°C	32 to 4208°F
D	0 to 2315°C	32 to 4199°F
E	-240 to 1000°C	-400 to 1832°F
J	-200 to 1200°C	-328 to 2192°F
K	-240 to 1373°C	-400 to 2503°F
L	0 to 762°C	32 to 1402°F
N	0 to 1399°C	32 to 2551°F
PtRh 20%:40%	0 to 1850°C	32 to 3362°F
R	0 to 1759°C	32 to 3198°F
S	0 to 1762°C	32 to 3204°F
T	-240 to 400°C	-400 to 752°F

Thermocouple Calibration: ±0.1% of full range, ±1LSD (±1°C for internal CJC if enabled). Linearization better than better ±0.2°C (±0.05 typical) on ranges marked * in the table above. Linearization for other ranges is better than better than ±0.5°C. BS4937, NBS125 & IEC584

Type	Range °C	Range °F
3-Wire PT100	-199 to 800°C	-328 to 1472°F
NI120	-80 to 240°C	-112 to 464°F

RTD Calibration: 0.1% of full range, ±1LSD. Linearization better than ±0.2°C (±0.05 typical). PT100 input to BS1904 & DIN43760 (0.00385Ω/Ω/°C).

RTD Excitation: Sensor current 150µA ±10%.
Lead Resistance: <0.5% of span error for max 50Ω per lead, balanced.

Type	Range	Offset Range
mA DC	0 to 20mA DC	4 to 20mA DC
mV DC	0 to 50mV DC	10 to 50mV DC
V DC	0 to 5V DC	1 to 5V DC
V DC	0 to 10V DC	2 to 10V DC
Potentiometer	≥100 ohms	N/A

Maximum Overload: 1A or 30V on voltage input terminals (at 25°C ambient).

DC Calibration: ±0.1% of full range, ±1LSD.

DC Input Multi-Point Linearization: Up to 15 scaling values can be defined anywhere between 0.1 and 100% of input.

Function	Input 1	Input 2
Process Control	Loop 1	Loop 2
Cascade Control	Master Loop	Slave Loop
Ratio Control	Controlled Variable	Un-controlled Variable
Remote Setpoint (RSP)	-	RSP on loop 1
Valve Position Feedback	-	Valve on loop 1

AUXILIARY INPUT A

Type	Range	Offset Range
MA DC	0 to 20mA DC	4 to 20mA DC
V DC	0 to 5V DC	1 to 5V DC
V DC	0 to 10V DC	2 to 10V DC

Accuracy: ±0.25% of input range ±1 LSD.

Sampling Rate: 4 per second.

Resolution: 16 bits.

Impedance: >10MΩ resistive, except DC mA (10Ω) and V (47kΩ).

Sensor Break Detection: 4 to 20mA, 2 to 10V and 1 to 5V ranges only. Control goes to pre-set power value if Aux Input is the active setpoint source.

Isolation: Reinforced safety isolation from outputs and other inputs.

Input Function: Remote Setpoint (RSP) input, Scalable between ±0.001 & ±10000, but always constrained by the setpoint limit settings.

DIGITAL INPUTS A & C

Selectable Digital Input Functions:

Function	Logic High*	Logic Low*
Loop 1 Control Select	Enabled	Disabled
Loop 2 Control Select	Enabled	Disabled
Loop 1 Auto/Manual Select	Automatic	Manual
Loop 2 Auto/Manual Select	Automatic	Manual
Loop 1 Setpoint Select	Main SP	Alternate SP
Loop 2 Setpoint Select	Main SP	Alternate SP
Loop 1 Pre-Tune Select	Stop	Run
Loop 2 Pre-Tune Select	Stop	Run
Loop 1 Self-Tune Select	Stop	Run
Loop 2 Self-Tune Select	Stop	Run
Profile Run/Hold	Hold	Run
Profile Hold Segment Release	No Action	Release
Profile Abort	No Action	Abort
Data Recorder Trigger	Not Active	Active
Output n Forcing	Off/Open	On/Closed
Clear All Latched Outputs	No Action	Reset
Output n Clear Latch	No Action	Reset
Key n Mimic (for)	No Action	Key Pressed
Inputs C1-C7 can be used as Binary or BCD Profile Selection	Binary 0	Binary 1

*The High/Low function can be switched using Inputs to Invert.
Inputs work in parallel with equivalent menus, so either can change the function status. Response <0.25 second.
= Level Sensitive: High or low sets status.

= Edge Sensitive: High-Low or Low-High transition changes function. Pre-Tune always off at power on (except auto pre-tune), but others retain their power-off status at power-on.

Inputs held high via pull-up resistors.
Logic High = Open contacts (>5000Ω) or 2 to 24VDC signal.
Logic Low = Closed contacts (<50Ω) or -0.6 to +0.8VDC signal.

Inverted Logic: Swaps the actions listed above (e.g. Profile Aborts on Logic High if selected input is inverted).

Number Available: 0 to 9. One from Module Slot A, 8 from Multi-Digital Input C
Isolation: Reinforced safety isolation from outputs and other inputs.

OUTPUTS

Caution: Plastic pegs prevent fitting of older non-reinforced single relay modules - Remove the peg to fit dual relays (all dual relay modules have reinforced isolation)

Single Relay 1-3
Type: 1 x Single pole double throw (SPDT). Plug-in Modules 1, 2 & 3.
Rating: 2A resistive at 120/240VAC with >500,000 operations at full rated AC voltage/current. De-rate for DC loads.

Isolation: Reinforced safety isolation from inputs and other outputs.

Dual Relay 2-3
Type: 2 x Single pole single throw (SPST*). Plug-in Modules 2 & 3.
Rating: 2A resistive at 120/240VAC with >200,000 operations at full rated AC voltage/current. De-rate for DC loads.
*Dual relay modules have shared common terminal.

Isolation: Reinforced safety isolation from inputs and other outputs.

Base Relay 4-5
Type: 1 x single pole single throw (SPST). Base outputs 4 & 5.
Rating: 2A resistive at 120/240VAC with >200,000 operations at full rated voltage/current. De-rate for DC loads.

Isolation: Reinforced safety isolation from inputs and other outputs.

SSR Driver 1-3
Type: 1 x Logic / SSR Driver output. Plug-in Modules 1, 2 & 3.
Drive Capability: Driver voltage >10V into 500Ω minimum.
Isolation: Isolated from all inputs/output except other SSR driver outputs.

2x SSR Driver 2-3
Type: 2 x Logic / SSR Driver outputs*. Plug-in Modules 2 & 3.
Drive Capability: Driver voltage >10V into 500Ω minimum.
*Dual SSR Driver modules have shared positive terminal.

Isolation: Isolated from all inputs/output except other SSR driver outputs.

Triac 1-3
Type: 1 x Triac output. Plug-in Modules 1, 2 & 3.
Operating Voltage: 20 to 280Vrms (47 to 63Hz)
Current Rating: 0.01 to 1A (full cycle rms on-state @ 25°C); de-rates linearly above 40°C to 0.5A @ 80°C.

Isolation: Reinforced safety isolation from inputs and other outputs.

Linear DC 1, 6-7
Type: 1 x Analogue DC output. Plug-in Module 1 & Base outputs 6 & 7.
Ranges: 0 to 5, 0 to 10, 2 to 10V & 0 to 20, 4 to 20mA (selectable) with 2% over/under-drive when used for control outputs, or 0-10V adjustable Transmitter PSU.

Resolution: 8 bits in 250mS (10 bits in 1s typical, >10 bits in >1s typical).
Accuracy: ±0.25% of range, (mA @ 250Ω, V @ 2kΩ). Degrades linearly to ±0.5% for increasing burden (to specification limits).

Isolation: Reinforced safety isolation from inputs and other outputs.

Transmit PSU 2-3
Type: 1 x DC Excitation output. Plug-in Modules 2 & 3. Caution: Only one Transmit PSU is supported. Do not fit in both positions.

Power Rating: 24V nominal (19 to 28V DC) into 910Ω minimum resistance. (Option to use DC Linear output as 0-10V stabilised PSU).

Isolation: Reinforced safety isolation from inputs and other outputs.

COMMUNICATIONS

PC Configuration
Functions: PC software configuration, data extraction and profile creation.
Connection: RS232 via PC Configurator Cable to RJ11 socket under case.
Isolation: Isolated from all inputs/output except SSR drivers. For bench configuration only. **CAUTION:** Do not use in live applications.

RS485
Functions: Setpoint broadcast master or general communications slave (inc. extraction of data recordings, transfer of configuration & profile files to/from PC software).
Connection: Plug-in Module Slot A. Connection to rear terminals 16-18.
Protocol: Modbus RTU.

Address Range: Slave address 1-255 or Setpoint master broadcast mode.
Supported Speeds: 4800, 9600, 19200, 38400, 57600 or 115200 bps.

Data Type: 10 or 11 (1 start & 1 stop bit, 8 data bits plus 1 optional parity bit).
Isolation: 240V reinforced safety isolation from all inputs and outputs.

Ethernet
Functions: General communications (inc. extraction of data recordings, transfer of configuration & profile files to/from PC software).
Connection: Locates in Module Slot A. Connection via RJ45 connector on top of case.

Protocol: Modbus TCP. Slave only.
Supported Speed: 10BaseT or 100BaseT (automatically detected).

Isolation: 240V reinforced safety isolation from all inputs and outputs

USB
Functions: Extraction of data recordings, transfer of configuration & profiles files to/from PC software or direct to another controller.
Connection: Connection via optional front mounted connector.

Protocol: USB 1.1 or 2.0 compatible. Mass Storage Class.

Supply Current: Up to 250mA.

Targeted Peripheral: USB Memory Stick.

Isolation: Reinforced safety isolation from all inputs and outputs.

LOOP CONTROL

Control types: **1 or 2 control loops**, each with either standard PID (single or dual control) or Valve Motor Drive (3-point stepping PID control).
2 internally linked cascade loops, with standard PID (single or dual control) or Valve Motor Drive (3-point stepping PID control).
1 Ratio loop for combustion control.
VMD Feedback: Second input can provide valve position feedback or flow indication. Feedback not required or used for control algorithm.

Tuning Types: Pre-tune, Auto Pre-tune, Self-tune or manual tuning with up to 5 PID sets stored internally.
Gain Scheduling: Automatically switches the 5 PID sets at user definable break-points relating to PV or SP value.

Proportional Bands: Single (Primary) or Dual (Primary & Secondary - e.g. Heat & Cool) 1 to 9999 display units or On-Off control.
Automatic Reset: Integral Time Constant, 1s to 99min 59s or OFF

Rate: Derivative Time Constant, 1s to 99 min 59s or OFF
Manual Reset: Bias 0 to 100% (-100% to +100% with Dual control).
Deadband/Overlap: Overlap (+ve values) or Deadband (-ve values) between Primary & Secondary Proportional Bands for Dual Control. Adjustable In display units - limited to 20% of the combined primary & secondary proportional band width.

Differential: ON-OFF switching differential 1 to 300 display units
Auto/Manual Control: Selectable with "bumpless" transfer when switching between Automatic and Manual control.
Cycle Times: Selectable from 0.5s to 512s.
Setpoint Ramp: Ramp rate selectable 1 to 9999 LSDs per hour or Off (infinite).

ALARMS

Alarm Types: 7 alarms can be assigned as Process High; Process Low; PV-SP Deviation; Band; Control Loop; Rate Of Signal Change per minute - all with adjustable minimum duration* before activation and optional start-up inhibit function.
Input Signal Break; % Recorder Memory Used, Control Power High, Control Power Low or Unused.
CAUTION: If the duration is less than this time, the alarm will not activate no matter what the signal value is.

Alarm Hysteresis: Adjustable deadband from 1 LSD to full span (in display units) for Process, Band or Deviation Alarms.

Combination Alarm & Events Outputs: Logically AND or OR any alarm or profile event (inc Profile running or ended) to switch an output. This can be when the condition is true, or the condition is not true.

DATA RECORDER

Recording Memory: 1Mb non-volatile flash memory. Data retained when power is turned off.
Recording Interval: 1; 2; 5; 10; 15; 30 seconds or 1; 2; 5; 10; 15; 30 minutes.
Recording Capacity: Dependant on sample rate and number of values recorded. Example: Two values will record for 21 days at 30s intervals. More values or faster sample rates reduce the duration.

RTC Battery Type: VARTA CR 1616 3V Lithium.
Clock runs for >1 year without power.

RTC accuracy: Real Time Clock error <1second per day.

PROFILER

A Profiler Enable Key can be purchased from your supplier if the feature is disabled.

Profile Capacity: Max 255 segments, shared by max 64 profiles
Segment Types: Ramp Up/Down over time, Ramp Rate Up/Down*, Step, Dwell, Hold, Loop, Join A Profile, End or Repeat Sequence Then End. *Ramp Rate Up/Down is not available when profile controls two loops

Timebase: hh:mm:ss (Hours, Minutes & Seconds).
Segment Time: Maximum segment time 99:59:59 hh:mm:ss. Use loop-back for longer segments (e.g. 24:00:00 x 100 loops = 100 days).

Ramp Rate: 0.001 to 9999.9 display units per hour.
Hold Segment Release: Release With Key Press, At Time Of Day or Digital Input.

Profile Starting Point: The first segment setpoint(s) begin from either the setpoint, or current measured input value, of the controlled loop(s)
Delayed Start: After 0 to 99:59 (hh:mm) delay, or at specified day(s) & time.
End On: Keep Last Profile Setpoint, Use Controller Setpoint or Control Outputs Off.

Abort Action: Keep Last Profile Setpoint, Use Controller Setpoint or Control Outputs Off.

Power/signal Loss Recovery: Continue Profile, Restart Profile, Keep Last Profile Setpoint, Use Controller Setpoint or Control Outputs Off.

Auto-Hold: Hold if input >Band above and/or below SP for each segment.
Profile Control: Run, Manual Hold/Release, Abort or jump to next segment.

Profile Timing Accuracy: 0.02% Basic Profile Timing Accuracy.
Accuracy: ±<0.5 second per Loop, End or Join segment.

Profile Cycling: 1 to 9999 or Infinite repeats per profile.
Sequence Repeats: 1 to 9999 or Infinite repeats of joined profile sequence.

Loop Back: 1 to 9999 loops back to specified segment.
Segment Events: Events turn on for the duration of the segment. For End Segments, the event state persists until another profile starts, the user exits from profiler mode, or the unit is powered down.

OPERATING CONDITIONS (FOR INDOOR USE)
Temperature: 0°C to 55°C (Operating), -20°C to 80°C (Storage).
Relative Humidity: 20% to 90% non-condensing.

Altitude: <2000m above sea level.
Supply Voltage and Power: Mains versions: 100 to 240VAC ±10%, 50/60Hz, 20VA. Low voltage versions: 20 to 48VDC 50/60Hz 15VA or 22 to 65VDC 12W.

Front Panel Cleaning: Wash with warm soapy water and dry immediately. Close the USB cover (if fitted) before cleaning.

CONFORMANCE NORMS
EMI: CE: Complies with EN61326.
Safety Considerations: CE: Complies with EN61010-1 edition 3. UL, cUL to UL61010C-1. Pollution Degree 2, Installation Category II.

Front Panel Sealing: To IP66 (IP65 front USB connector). IP20 behind the panel. (IP rating not recognised / approved by UL).

DISPLAY
Display Type: 160 x 80 pixel, monochrome graphic LCD with a two colour (red/green) backlight.
Display Area: 66.54mm (W) x 37.42mm (H).
Display Characters: 0 to 9, a to z, A to Z, plus () @ ÷ β - and _

Trend Views: One optional trend graph for each control loop each with 120 of 240 data points shown in a scrollable window. Data is not retained when power turned off or if time base is changed.
Trend Data: Any active alarm, plus PV (solid) & SP (dotted) at sample time or Max/Min PV between samples (candle-stick graph). Auto scales from 2 to 100% of Input Span.

Trend Sample Rate: 1; 2; 5; 10; 15; 30 seconds or 1; 2; 5; 10; 15; 30 minutes. Set independently for each trend graph.

DIMENSIONS
Weight: 0.65kg maximum.
Size: 96 x 96mm (Front Bezel). 117mm (Depth Behind Panel).
Mounting Panel: Panel must be rigid. Maximum thickness 6.0mm (0.25inch).
Panel Cut-out Size: 92mm x 92mm. Tolerance +0.5, -0.0mm.
Ventilation: 20mm gap required above, below and behind.

19. SERIAL COMMUNICATIONS

Refer to **Communications Configuration** on page 6 for general communications settings, and Configuration via Software in section 22 if you need to set the Ethernet options IP address.

NOTE: The Full Product Manual (from your supplier) has detailed communications protocol and parameter addressing information.

20. SCREEN SEQUENCES

Menus & screens displayed depend on how the instrument is configured. Most screens revert to Operation Mode after 2 minutes without key activity, those marked **W** below persist. Menus marked **W** = Require un-lock codes for access. Screens marked **W** are only shown if enabled in Display Configuration.

Screen Navigation

- ⏪ = Accept Value & Move Back
- ⏩ = Next Item/Increment
- ⏮ = Prior Item/Decrement
- ⏭ = Accept Value & Move Forward
- ⏶ + ⏷ = Move Up One Menu Level
- ⏷ or ⏸ for >1sec accepts ALL values & skips to next/previous screen. Symbols ⇄ show to the right of menu lists when more options are available above ^ or below v.

Screen Navigation	Operation Mode:
Calibration Check Due Warning	Ⓜ If a Calibration Reminder is set in Input Configuration, and the due date has passed. - Recorder version only. Press ⏪ + ⏩ to postpone calibration.
LED Labels:	Ⓜ LED indicator functions. Defaults are PRI, SEC, TUNE & ALARM - LED functions and their labels can be altered with the configuration software.
Process Value & Setpoint (or MAN):	Ⓜ Process values and effective Setpoint (%Manual Power in Manual Mode or Valve Open / Stop / Close for VMD Manual Mode).
Bar Graphs:	Ⓜ Control Deviation graph (±5% span) and Power graph (0-100% primary, ±100% primary & secondary or Valve OPEN / STOP / CLOSE in VMD mode). If VMD Control with input 2 used for position feedback, the power bar-graph shows 0 to 100% valve position.
LED Labels:	Ⓜ LED indicator functions. Defaults are PRI, SEC, TUNE & ALARM - LED functions and their labels can be altered with the configuration software.
Process Value & Setpoints (or MAN):	Ⓜ Process values and effective Setpoint values for both loops (%Manual Power in Manual Mode or Valve Open / Stop / Close for VMD Manual Mode).
Bar Graphs:	Ⓜ Control Deviation graphs (±5% span) and Power graphs (0-100% primary, ±100% primary & secondary or Valve OPEN / STOP / CLOSE in VMD mode).
LED Labels:	Ⓜ LED indicator functions. Defaults are PRI, SEC, TUNE & ALARM - these labels can be altered with configuration software.
Cascade Status, Master & Slave	Ⓜ Cascade Status. Cascade = Cascade operating; Cascade Open = master / slave loops not linked. Master & Slave Process Values. Master Setpoint value (Slave Setpoint if Cascade Open, or Manual Power level in Manual Mode).
Process Values & Setpoint (or MAN):	Ⓜ Control Deviation graph (±5% span) and Power graph (0-100% primary, ±100% primary & secondary or Valve OPEN / STOP / CLOSE in VMD mode).
Bar Graphs:	Ⓜ
LED Labels:	Ⓜ LED indicator functions. Defaults are PRI, SEC, TUNE & ALARM - these labels can be altered with configuration software.
Ratio:	Ⓜ Relative Ratio value and relative Setpoint value.
Ratio Setpoint (or MAN):	Ⓜ Ratio Setpoint value (or Manual Power level when in Manual Mode).
Bar Graph:	Ⓜ Control Deviation graph (±5% span) and Power graph (0-100%).
Profile Control	Ⓜ If a profile is running, from: Do Nothing; Abort Profile (end immediately); Jump to Next Profile Segment; Hold Profile or Release Hold If profile not running, from: Do Nothing; Run Profile; Select Profile; End Profile Control; (return to std. controller operation).
LED Labels:	Ⓜ LED indicator functions. Defaults are PRI, SEC, TUNE & ALARM - these labels can be altered with configuration software.
Process Value & Setpoints (or MAN):	Ⓜ Process values and effective Setpoint values (%Manual Power in Manual Mode or Valve Open / Stop / Close for VMD Manual Mode).
Bar Graphs:	Ⓜ Profile name & progress bar graph with Running/Held/Stopped indicator. Current profile segment progress bar graph, with segment number and type.
Event Status	Ⓜ Active / inactive status of all configured Events - Profiler mode only.
Cascade Mode	Ⓜ Cascade-Open breaks the master-slave link when commissioning & tuning. Slave SP is adjustable directly. Caution: Return to Cascade when finished!
Auto/Manual Control Selection	Ⓜ Switches the loop shown between automatic and manual control - setpoint replaced by manual power level in manual mode.
Setpoint Value Display & Adjustment	Ⓜ View and adjust local (internal) setpoints for the loop. The "active" SP is marked. - Remote setpoints are read only.
Setpoint Ramp Rate	Ⓜ Setpoint Ramp Rate adjustment for the loop shown (in display units per hour).
Select Active Setpoint	Ⓜ Selects if the main or alternate setpoint is active for the loop shown.
Control Enable	Ⓜ Enables/disables the control loop outputs for the loop shown - setpoint is replaced by "OFF" when disabled.
Alarm Status	Ⓜ Lists any active alarms. The titles "Alarm n" can be replaced with the PC configuration software to a user defined 8 character name for each alarm.
Recorder Latched Outputs	Ⓜ Hold down ⏪ or ⏩ for 3 seconds to clear selected latched output - Output only resets if the condition that caused it to latch on is no-longer present.
Recorder Memory Full Warning	Ⓜ Warns if the recorder memory is used up and that recording has either stopped or is overwriting older data if in FIFO recording mode.
Manual Recorder Trigger	Ⓜ Set the manual recording trigger on or off. Even if set to off, recording will still take place if another recording trigger is active.
Recorder Status Information	Ⓜ Status (Recording or Stopped); active trigger icons; recording mode & time remaining and a %memory bar-graph - see the Data Recorder, section 17.
Trend View (Loop 1)	Ⓜ A trend graph of PV & SP, or the Max/Min value of the PV between samples. Any active alarm(s) are indicated at the top of the graph.
Trend View (Loop 2)	Ⓜ A trend graph of PV & SP, or the Max/Min value of the PV between samples. Any active alarm(s) are indicated at the top of the graph.
Custom Display screens	Ⓜ Up to 50 Configuration parameters can be copied into Operation Mode using the PC software. In this mode they are not pass code protected.
	Note: Operation Mode screens can be made globally read only from Display Configuration
Setup Wizard:	
Setup Wizard Unlocking	Ⓜ Enter correct code number to access Setup Wizard. <i>Default Value = 10</i>
Reset Defaults or Continue	Ⓜ Decide whether start wizard with current settings or default values (recommended). Caution: Resetting defaults all parameters, not just those covered by the quick setup wizard. For more complex applications the user may have to reconfigure other Configuration Mode settings before using the instrument.
Screens marked W ...	Ⓜ Press ⏪ to select each major configuration parameter in turn. Follow the on-screen prompts to alter the values.
Setup Wizard Completed	Ⓜ Confirms completion of the Setup Wizard. Exits to Operation Mode.
Supervisor Mode:	
Supervisor Mode Unlocking	Ⓜ If Supervisor Mode is configured (requires PC software to configure screens sequence), enter correct code number to continue. <i>Default Value = 10</i>
Supervisor Mode Screens	Ⓜ Press ⏪ to select up to 50 Configuration parameters in turn. Follow on-screen prompts to alter values. - see their Configuration Menu entry for details.
Configuration Menu:	
Configuration Mode Unlocking	Ⓜ Enter correct code number to access Configuration Mode. <i>Default Value = 10</i>
Configuration Options	Ⓜ Select required Configuration Menu Option from list. Press ⏪ to continue. Refer to the Configuration Menu sequences on the following page for information about the Configuration Sub-Menus
USB Menu:	
USB Mode Unlocking	Ⓜ Enter correct code number to access USB Menu. <i>Default Value = 10</i>
Read/Write To USB Device	Ⓜ From: Read/Write Configuration File; Write Recorder Log File or Read/Write Profile File.
Select Profile To Write	Ⓜ If writing a profile to the USB Memory Stick, choose a profile to write from the list provided.
Enter A File or Folder Name	Ⓜ Enter an 8-character folder name for logs, or a file name for configurations and profiles. An extension (.bct for configurations, .pfl for profiles) is added automatically. Caution: Existing files/folders with the same name will be over-written.
Writing Profile/Configuration/Log	Ⓜ Recorder log, profile or configuration being written to USB. Caution: Do not disconnect USB device until completed! Data loss or corruption may result.
Transfer Successful	Ⓜ Confirmation of successful data transfer. Press ⏪ to continue
Select File	Ⓜ Select the Configuration or Profile file to transfer from the USB stick. Caution: A configuration read overwrites all existing instrument settings.
Reading Profile/Configuration	Ⓜ Profile or configuration is being read. Caution: Do not remove the memory stick whilst this operation is in progress. Data loss or corruption may result.
Transfer Successful	Ⓜ Confirmation of successful data transfer. Press ⏪ to continue
Transfer Failure	Ⓜ For write failures, check the disk space on the USB stick. For read failures, check the maximum number of profiles/segments is not being exceeded.
Recorder Control:	
Recorder Mode Unlocking	Ⓜ Enter correct code number to access Data Recorder Menu - <i>Default Value = 10.</i>
Manual Recorder Trigger	Ⓜ Turn on or off the manual recording trigger. Note: Recording continues if another trigger active (e.g. on alarm/profile; manual start or digital input).
Recorder Status Information	Ⓜ Status (Recording or Stopped); active trigger icons; recording mode & time remaining and a %memory bar-graph - see the Data Recorder in section 17.
Clear Recordings?	Ⓜ Clears the recorder memory. Caution: Permanently removes ALL recorded data. - Only shown if recording is stopped.

Continued....

Profile Setup:	
Profile Setup Menu Unlocking	Ⓜ Enter correct code number to access the Profile Setup Menu. <i>Default Value = 10</i>
General Profile Configuration:	Sub-menu with global settings affecting all profiles. Press ⏪ + ⏩ to return to Profile Setup Menu
Enable Edit While Running	Ⓜ Enables/disables the ability to edit profiles whilst a profile is running. Note: current or next segment will not change until after profile is restarted.
Timer Start Function	Ⓜ If enabled, delayed timer starts are possible, and if the selected profile has a day & time trigger waits until the time set, then starts automatically. If disabled, profiles can only be manually started, and with immediate effect (delays or timer starts ignored).
Create A Profile	Sub-menu to Create profiles. A warning is displayed if 64 profiles or 255 segments is exceeded. Press ⏪ + ⏩ to return to Profile Setup Menu
Enter Profile Name	Ⓜ Up to 16 characters can be used to give each profile a unique descriptive name.
Number of Loops Linked to Profile.	Ⓜ Select if this profile will: 1) Control the setpoint of first loop only or; 2) Control the setpoint of both loops. This setting cannot be edited later. Note: the segment type and time settings are common to both loops.
Profile Starting Setpoint	Ⓜ From: Current Setpoint or Current Process Variable. Uses the measured PV or effective SP when profile is started, for the beginning of the first segment.
Profile Start Trigger	Ⓜ From: None (profile start is not delayed); After Delay or Day and Time. Note: Delay and Timer triggers only effective if enabled with Timer Start Function.
Profile Start Time	Ⓜ The time (hh:mm) when the profile should run. - if Day and Time is the Profile Start Trigger. Caution: Take care not to clash with other profiles.
Profile Start Day(s)	Ⓜ Day(s) when the profile should run. From: Mon; Tue; Wed; Thu; Fri; Sat; Sun; Mon-Fri; Mon-Sat; Sat-Sun or Every Day. - if Day and Time is the Trigger.
Profile Start Delay Time	Ⓜ The delay time, up to 99:59 (hh:mm), for a profile to wait after the start request has been given. Profile only begins when this time has elapsed.
Profile Recovery Method	Ⓜ Power-on action if profile was running at power-down (e.g. a power cut), or following correction of a signal break. From: Control outputs off; Restart profile; Maintain last profile setpoint; Use controller setpoint; Continue profile from where it was when power failed.
Profile Recovery Time	Ⓜ Recovery Method is ignored (profile continues from where power failed), if power is off for less than this time. Max 99:59 (hh:mm). - Recorder only.
Profile Abort Action	Ⓜ Action after profile is forced to stop before its end. From: Control outputs off; Maintain last profile setpoint or Use controller setpoint.
Profile Cycles	Ⓜ The number of times the program should run each time it is started (1-9999 or Infinite).
Segment Number	Ⓜ Shows the number of the profile segment being created from 1-255
Segment Type	Ⓜ From: Ramp Time (time to reach target SP); Ramp Rate (rate of change towards target SP - Single loop profiles only); Step (jump to target SP), Dwell (keep current SP); Hold (hold profile until released); Loop (back to previous segment); Join (to another profile); End or Repeat Sequence Then End.
Loop 1 Target Setpoint.	Ⓜ The setpoint value Loop 1 should be reached by the end of this segment if type is Ramp Time, Ramp Rate or Step.
Loop 2 Target Setpoint.	Ⓜ The setpoint value Loop 2 should be reached by the end of this segment if type is Ramp Time or Step. - Two-Loop profiles only.
Segment Ramp Time	Ⓜ The time (hh:mm:ss) for the loops to reach their Segment Target Setpoints - if segment type is Ramp Time.
Segment Ramp Rate	Ⓜ The rate of change towards the Segment Target Setpoint if segment type is Ramp Rate. The rate can be set from 0.001 to 9999.9 units per hour.
Segment Dwell Time	Ⓜ The time (hh:mm:ss) the loop(s) maintain their current setpoint(s).
Number of Loops	Ⓜ For Loop Segments, enter the number of times to loop back to a previous segment, before continuing forward to the next segment.
Back to Segment Number	Ⓜ For Loop Segments, enter the segment to loop back to from the list of segments shown. Note: loops must not cross.
Loop 1 Auto-Hold Type	Ⓜ From: None (no auto-hold); Above Setpoint (hold if too high); Below Setpoint (hold if too low or low).
Loop 1 Auto-Hold Band Value	Ⓜ The distance from loop 1 setpoint beyond which the profile is held.
Loop 2 Auto-Hold Type	Ⓜ Options as for Loop 1 - Two-Loop profiles only.
Loop 2 Auto-Hold Band Value	Ⓜ The distance from loop 2 setpoint beyond which the profile is held.
Hold Segment Release Type	Ⓜ A hold segment can either be released by an Operator/Digital input or be set wait until a specified Time of Day - Recorder version only.
Hold Release Time	Ⓜ Time of day (hh:mm) when a Hold Segment will release - if Release Type is Time Of Day. The segment releases at the next occurrence of this time.
Times To Repeat Sequence	Ⓜ The number of times the entire sequence of profiles should run. - if the last segment is Repeat Sequence Then End.
Segment End Type	Ⓜ Action after profile ends. From: Control outputs off; Maintain last profile setpoint; Use controller setpoint.
Select Profile To Join	Ⓜ Choose a profile to join to from the list provided. Chosen profile will start immediately the current profile ends. - if final segment set as a Join.
Event n	Ⓜ Select if events (1 to 5) are active during this segment. For end segments. Active events stay on until the unit exits profiler mode or a new profile runs.
Edit A Profile Header	Ⓜ Choose the profile to be edited from the list of profile names provided. The number of loops in a profile cannot be changed.
Edit A Profile Segment	Ⓜ Choose the profile and segment to be edited from the lists. Other segments cannot be changed into End, Join or Repeat types.
Insert A Segment	Ⓜ Choose the profile and position of new segment from the lists provided. End, Join or Repeat segments cannot be inserted.
Delete A Segment	Ⓜ Choose the profile and then the segment to be deleted from the lists provided. End, Join or Repeat segments cannot be deleted.
Delete A Profile	Ⓜ Choose the profile to be deleted from the list of names is provided.
Delete All Profiles	Ⓜ Deletes all profiles from memory. The user is prompted to confirm that all profiles should be deleted. Caution: Use with care!
Profile Control:	
Profile Control Menu Unlocking	Ⓜ Enter correct code number to access the Profile Control Menu. <i>Default Value = 10</i>
Profile Control	Ⓜ If a profile is running, from: Do Nothing; Abort Profile (end immediately); Jump to Next Profile Segment; Hold Profile or Release Hold If profile not running, from: Do Nothing; Run Profile; Select Profile; End Profile Control; (return to std. controller operation).
Select Profile	Ⓜ The profile chosen to run. Following confirmation, the selected profile starts (after a delay or at the digital input. If not chosen from the list of profiles. Selection is "read only" if profile selection is via digital input.
Service and Product Info:	
Plug-in Modules	Ⓜ Lists the type of Plug-in Modules (if any) fitted in module Slots 1, 2, 3 or A - see model code matrix for full list of field upgradeable plug-in options.
Base Options	Ⓜ Lists factory fitted base build options, from: 2nd Universal/Aux input; Output 4 & 5 Relay; Output 5 & 6 Linear.
Optional Features	Ⓜ Lists which other optional features are fitted/enabled, from: Profiler; USB Port; Data Recorder and 8 Digital Inputs.
Firmware Information	Ⓜ Type and version of firmware.
Product Revision Level	Ⓜ Software and Hardware update status
Serial Number	Ⓜ The Instrument serial number.
Date of Manufacture	Ⓜ The instrument Date of Manufacture (date format is dd/mm/yyyy).
Input 1 Calibration Status	Ⓜ Calibration status of mVDC, VDC, mADC, RTD and Thermocouple CJC inputs. Caution: All should be "Calibrated".
Input 2 Calibration Status	Ⓜ Calibration status of mVDC, VDC, mADC, RTD and Thermocouple CJC inputs. - Two Input versions only. Caution: All should be "Calibrated".
For Service Contact Information	Ⓜ Contact information for Service, Sales or Technical Support.
Automatic Tuning:	
Automatic Tuning Mode Unlocking	Ⓜ Enter correct code number to access Automatic Tuning Menu.
- Control loop 1 or 2 ...	Ⓜ For 2-loop controllers, select the loop to tune. If required the screens can be repeated for the other control loop.
Cascade Mode	Ⓜ To pre-tune a cascade slave, select open-cascade. Note: When slave tune complete, repeat choosing open-cascade to tune the master.
Pre-Tune Method	Ⓜ Pre-Tune Standard or Pre-Tune at Value
Pre-Tune Value	Ⓜ Set the value at which process is tested.
Pre-Tune Save Location	Ⓜ Store pre-tune result to one of 5 PID sets.
Run Pre-Tune on Set n Now?	Ⓜ Run Pre-Tune for the chosen PID Set.
Pre-Tune Status	Ⓜ Pre-Tune status: Running or Stopped.
Engage Self-Tune	Ⓜ Runs Self-Tune for the active PID Set.
Self-Tune Status	Ⓜ Self-Tune status: Running or Stopped.
Auto Pre-Tune at Power Up?	Ⓜ Enables/Disables Automatic Pre-Tune.

21. SUPERVISOR MODE

The purpose of this function is to allow selected operators access to a lock-code protected sub-set of the configuration parameters, without providing them with the higher level configuration menu unlock code. The PC software is used to copy up to 50 parameters from configuration menus for inclusion in the supervisor mode screen sequence. If the parameter is normally displayed on screen with another parameter, both parameters will appear.

NOTE: Supervisor mode is only available if one or more screens has been configured from the PC software. It is not possible to configure supervisor mode screens without using the software.

Table with multiple columns containing configuration options and their descriptions. Includes sections like Input Configuration, Input 1 Calibration, Input 2 Calibration, Digital Input Setup, Control Configuration, and Control Loop 1. Includes a vertical sidebar on the left: CONFIGURATION MENU OPTIONS.

Continued.....

Table with multiple columns containing configuration options and their descriptions. Includes sections like Main Setpoint Offset, Control Loop 2, Output Configuration, Alarm Configuration, Recorder Configuration, and Lock Code Configuration.

22. PC SOFTWARE SETTINGS

A communications settings screen is shown whenever the user attempts to connect to the instrument from the PC configuration software. If the settings are not as shown below, the PC configuration software cannot communicate with the instrument.

Table with 5 columns: Settings, Slot A Module, Bit Rate, Parity, Address. Contains data for Device connector, PC connector, Start bits, Data bits, Stop bits, Parity, Bit rate, and address.

Connection from PC to Rear RS485 Communications Option

Device connector = Bus. PC connector = the PC Serial Com port that you are connected to. Start and Stop bits = 1. Data bits = 8. Parity, Bit Rate & Address settings must match those set in the instruments Communication Configuration menu.

Connection from PC to Ethernet Port. Device connector = Bus. PC connector = Ethernet (bus coupler). IP Address = Instrument IP address. Port Address = 502. The supported data rates 10/100BASE-T (10 or 100 Mbps) are automatically detected.

Table with 2 columns: Device connector, Bus. Contains data for PC connector (Ethernet bus coupler), IP address (192.168.1.12), and Port address (502).