



Industrial controller KS 94

KS94

Operating Instruction

9499 040 44211

Gültig ab: 8363

Inhalt

1. Front view	5	9.6 Self-tuning (automatic optimization of control parameters)	13
2. Safety notes	5	9.7 Parameter and configuration level	14
3. Electromagnetic compatibility	5	10. Configuration.	15
4. Technical data → data sheet, order no. 9498 737 28233	5	10.1 General	15
5. Maintenance / Behaviour in case of trouble	6	10.2 Basic structure	15
6. Further information	6	10.3 Main groups	18
7. Mounting	6	10.4 CONTR: Controller	19
8. Electrical connections	7	10.5 SOURCE: Input signal allocation	21
8.1 Notes	7	10.6 INPUT: inputs	23
8.2 Connecting input INP1	7	10.7 OUTPT: outputs	27
8.3 Connecting input INP6	8	10.8 ALARM: alarms	31
8.4 Connecting input INP5	8	10.9 TUNE:self-tuning	32
8.5 Connecting the power supply	8	10.10 DISP: User interface for operation	32
8.6 Connecting the outputs OUT2/4/5	8	10.11 AUX: Additional functions	33
8.7 Connecting output OUT1	8	10.12 Examples of configuration	35
8.8 Digital inputs and outputs (di / do)	8	11. Parameters	36
8.9 Connecting the bus interface	9	11.1 General	36
8.10 Connecting the inputs INP3 / INP4	9	11.2 Set-point function	38
8.11 Connecting the output OUT3	9	11.3 Time function	38
8.12 Versions with integr. supply voltage	10	11.4 Programmer functions	38
9. Operation (survey)	11	11.5 Alarm function	39
9.1 The menus 1...3	11	11.6 Self-tuning	39
9.2 The operating level	11	11.7 Control algorithm	40
9.3 Operating the programmer:	12	11.8 Input processing	41
9.4 Calibration:	12	11.9 Miscellaneous	42
9.5 DAC – motor actuator monitoring (Digital Actor Control DAC®)	13	11.10 Signals	42
		12. Versions	43
		13.	43
		13.1 Input and output allocation with pre-configured units	44

Symbol definition:



General warning (caution, following the warnings in the instruction)



Protective earth



Earth connection

DAC® is a patented method and a registered trademark of Regeltechnik Kornwestheim GmbH.

All rights reserved. No part of this documentation may be reproduced or published in any form or by any means without prior written permission from the copyright owner

A publication of PMA Proze- und Maschinen-Automation. Subject to alterations without notice.
PMA Prozess- und Maschinen-Automation GmbH 2000, Printed in Germany (2003).

1. Front view

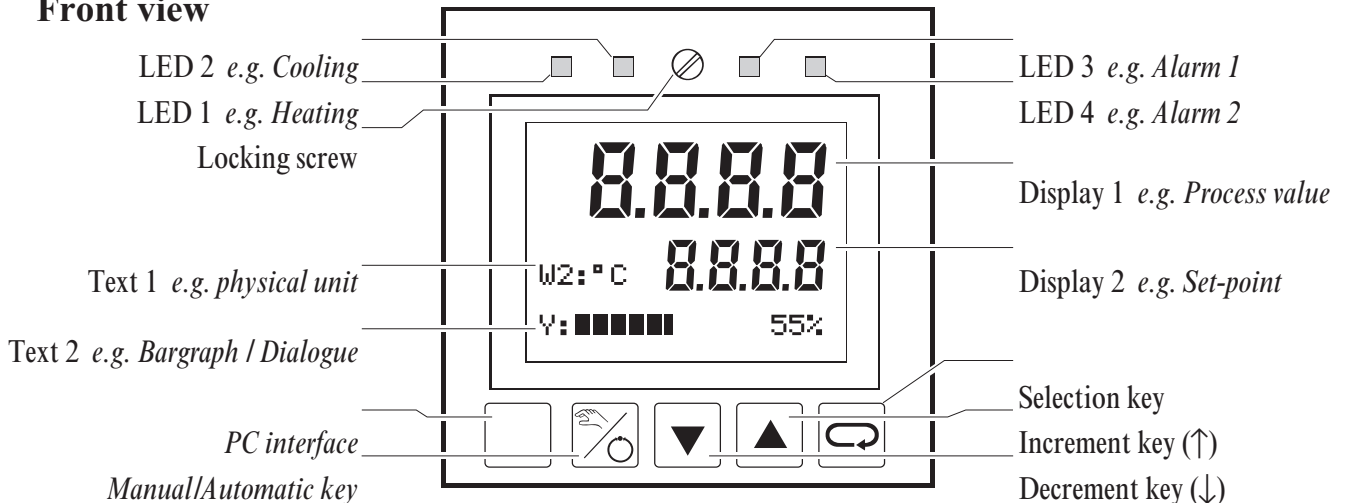

- **Locking screw:** Locks the controller module in the housing.
- **LEDs:** indicates the statuses of controller outputs Y1, Y2 and alarms LIM1, LIM2 (other settings at configuration level **L.800** → page 30).
- **Display 1:** indicates process value at operating and parameter level, or the configuration code at configuration level.
- **Display 2:** indicates the set-point (automatic mode) or the correcting value (manual mode) in operating level. The values are adjustable directly with **▲▼**. Further displays at operating level → page 9. In parameter and configuration level, values and codes described with text1 are indicated (→ page 12).
- **Text 1:** indicates the short-form dialogue or the unit of display 2.
- **Text 2:** indicates the output bargraph (other selections possible in configuration level C.800).
Keys **☰▼▲☰**: For the certain function → pages 9 and 12.
- **PC interface:** PC connection for configuration/parameter setting/operation with an engineering tool.

2. Safety notes

Following the enclosed safety instructions 9499 047 07101 is indispensable!

The insulation of the instrument conforms to EN 61 010-1 with pollution degree 2, overvoltage category III, operating voltage 300 V and protection class I. Additional with horizontal installation, a protection to prevent live part, e.g. wire ends, from dropping into the open housing of a withdrawn controller must be fitted.

3. Electromagnetic compatibility

The instrument conforms to **European Directive 89/336/EEC** and will be provided with the CE-marking. The following European Generic Standards are met: **Emission: EN 50081-2** and **Immunity: EN 50082-2**. The unit is suitable for use in industrial areas (in residential areas, RF interference may occur). The electromagnetic radiation can be reduced decisively by installing the unit in a grounded metal switch cabinet.

4. Technical data → data sheet, order no. 9498 737 28233

5. Maintenance / Behaviour in case of trouble

The controller needs no maintenance. The rules to be followed in case of trouble are:

- Check mains (voltage, frequency and correct connections),
- check, if all connections are correct,
- check the correct funktion of the sensors and final elements,
- check the configuration words for required functions and
- check the adjusted parameters for required operation. If the controller still does not work properly after these checks, shut down the controller and replace it.

Cleaning: Housing and Front can be cleaned by means of a dry, lint-free cloth. No use of solvents or cleansing agents!

6. Further information

A manual with the order no. 9499 040 44811 gives further information to the chapters of this operating notes.

7. Mounting

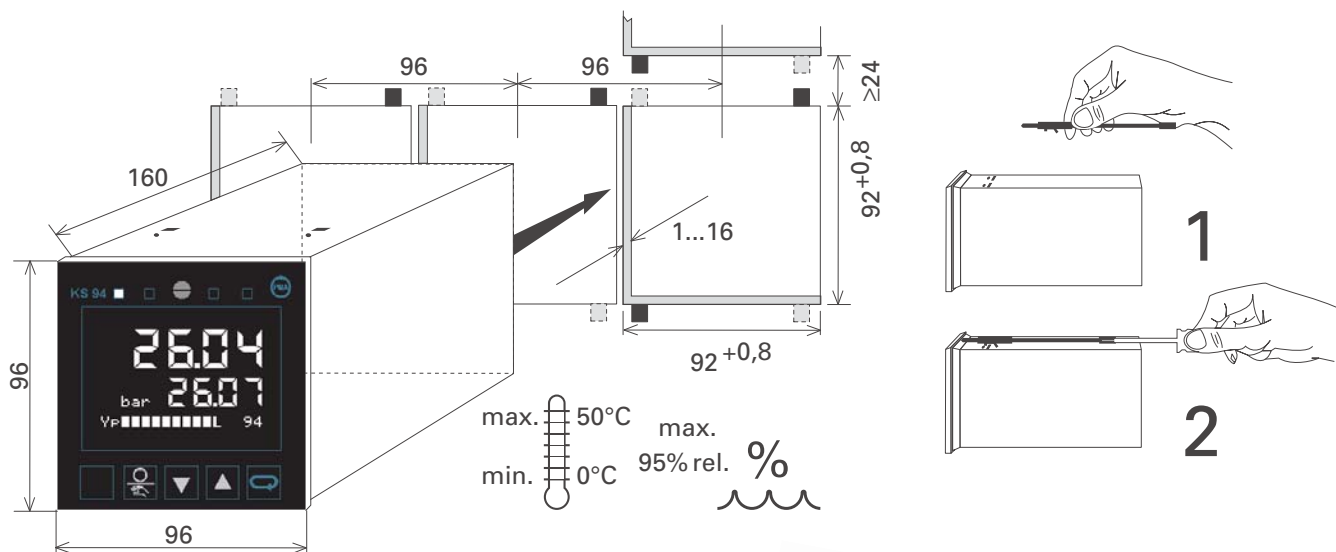

S.I.L. switch: with the switch closed, transition to parameter and configuration level is disabled.

When making an attempt to change over to the parameter level, "Paral" is displayed (text1).

Correcting variable, set-point and parameters at the "extended operating level" remain available for selecting and changing. For access to the S.I.L. switch, release the locking screw and withdraw the instrument module from the housing. Subsequently, re-insert the controller module into the housing and mount it with screws.

Protection mode IP65: 4 fixing clamps must be used. The instruments insert must be placed strongly an locked strongly by means of the locking screw.



Caution! The instrument contains ESD-hazarded components.

8. Electrical connections

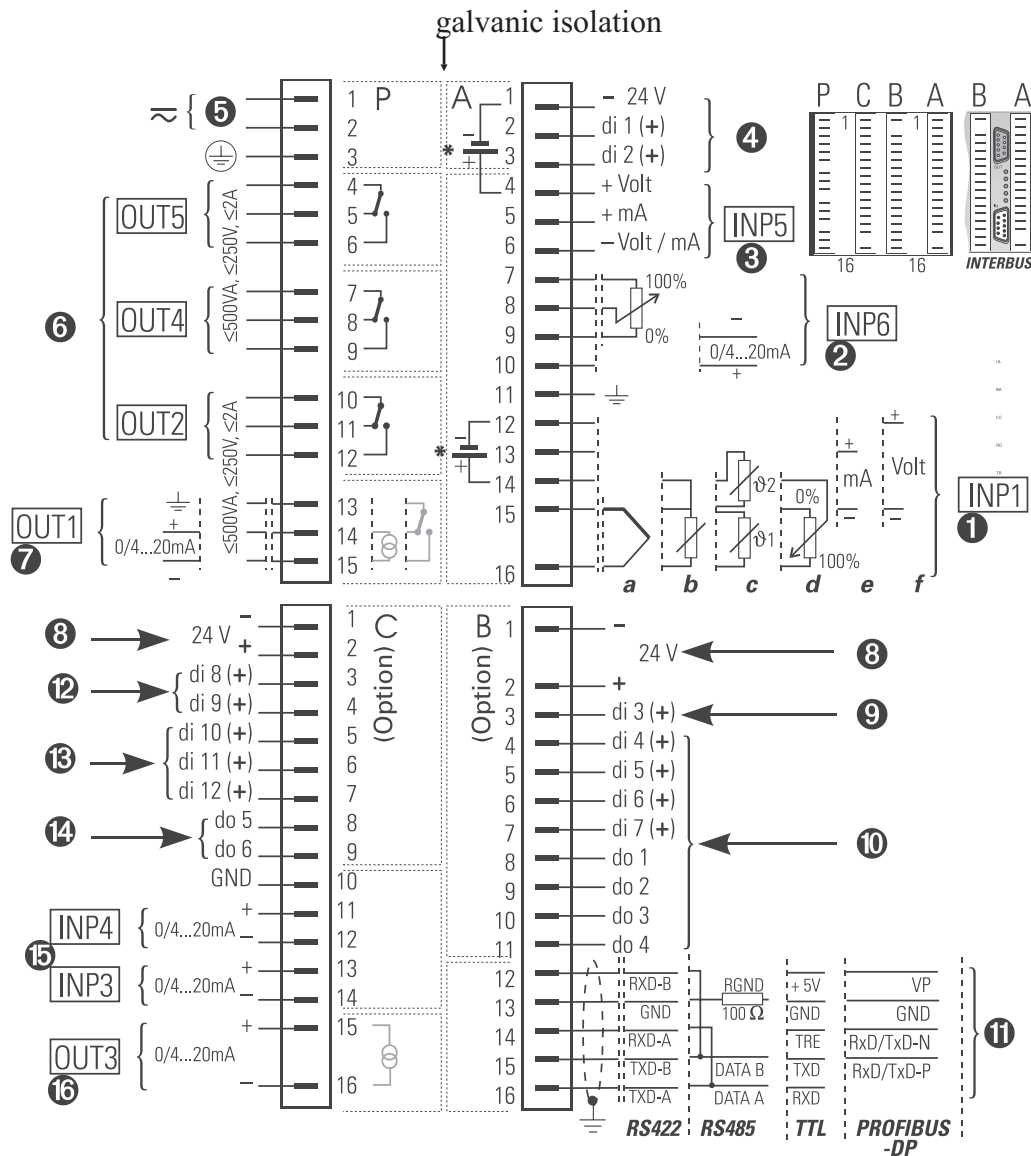

* Versions with integrated supply voltage (connection example look at page 10)

8.1 Notes

- The ground connection of earth terminal A11 (terminal P13 with continuous controllers, too) should be kept **separate** from the mains and as short as possible (15 cm during test). Keep **mains cables separate** from signal and measurement input leads. We recommend twisted and screened measurement input leads (screen contacted to measurement earth).
- When connecting a contactor to a relay output, an RC protective circuit is necessary, to avoid voltage peaks which can cause trouble to the controller.
- Individual or common fuse protection must be fitted (1 A per instrument).

8.2 Connecting input INP1 ①

Input for main process value x1 (actual value).

x1	a Thermocouple	b Resistance thermometer (Pt 100)	c Temperature difference ($\vartheta_1 - \vartheta_2$) (2x Pt 100)
	d Potentiometric transducer	e Current (0/4...20mA)	f Voltage (0/2...10V)

8.3 Connecting input INP6 ②

For position feedback with 3-point stepping controller (other selections possible in configuration level **£. 180**).

8.4 Connecting input INP5 ③



Input for process value x2 or external set-point or external set-point offset (configuration level **£. 180**). With voltage signals, A6 must be connected to the reference potential at A9.

8.5 Connecting the power supply ⑤

Depending on the version, the instrument is supplied with: 90...250 V AC or 24 V UC. The 24 V UC version is for 19,2...30 V DC or 20,4...26,4 V AC. The indicated values are the limits. The protective earth must be connected to terminal P3.

8.6 Connecting the outputs OUT2/4/5 ⑥

Relay outputs, corresponding to the controller output Y2 or the alarms LIM1 / LIM2 (other selections possible in configuration level →from page 26).

8.7 Connecting output OUT1 ⑦

Depending on the version, OUT1 is a relay, logic or continuous output corresponding to the controller output Y1 (other selections in configuration level). With logic and continuous outputs, P13 must be connected to the earth terminal. The logic signal is 0 / >20 mA (load ≤600 Ω) or 0 / >12 V (load ≥600 Ω).

8.8 Digital inputs and outputs (di / do) ④⑧⑨⑩⑫⑬⑭

The inputs operate as current sink (IEC 1131 type1), logic „0" = -3...5 V, logic „1" = 15...30 V. The outputs operate as „grounded load“. They are short circuit protected and contain recovery diodes. The digital input and supply voltage (24V) must be connected on each circuit board.

④ **di1 / di2** control various actions (set in configuration level **£. 190 / £. 191** and parameter **B1ck1 / B1ck2**)

⑨ **di3** is used for changeover Local mode(0) ↔ Remote mode(1).

⑩ **di4...di7** and **do1...do4** are correlated to the programmer as follows:

di4	Program STOP (0) ↔ RUN (1)	do1	Status fo control output 1
di5	Program normal (0) ↔ RESET (1)	do2	Status fo control output 2
di6	Program number (LSB)	do3	Status fo control output 3
di7	Program number (MSB)	do4	Status fo control output 4

di6	0	1	0/1
di7	0	0	1
program	1	2	3

di8	0	1	0	1
di9	0	0	1	1
parameterset	0	1	2	3

⑫ **di8 / di9** is used for selecting the parameter set (bei C.700 = xx . x . 3, di9 = MSB).

- 13 **di10** is the input for override control OVC+ (three-point stepping).
di11 is the input for override control OVC- (three-point stepping) or the correction of the effective set-point OFF (0) ↔ ON (1) (configuration level **190 / 191**).
di12 switches the bumpless transfer of the internal set-point (tracking) OFF (0) ↔ ON (1) or switches from set-point w (0) ↔ w2 (1) (configuration level **190 / 191**).
- 14 **do5** or **do6** indicates the status automatic ↔ manual or internal ↔ external set-point or the status of the controller outputs Y1 / Y2 with switching controllers (configurations **596 / 597**).
- 8 The digital inputs and outputs must be supplied from one or several external 24 V dc sources (current consumption 5 mA/input, max. load = 0,1 A/output). Examples:

Digital inputs (connect. A)

Digital inputs and outputs with one dc source (e.g. connector B)

Digital inputs and outputs with two dc sources (e.g. connector B)

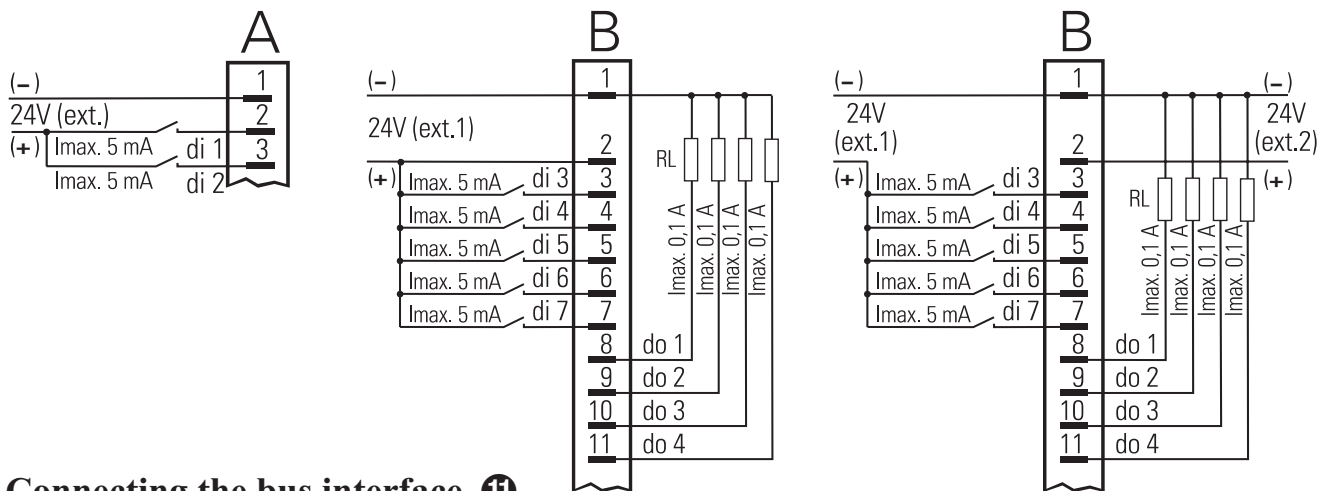

8.9 Connecting the bus interface 11

TTL level or RS422, RS485, PROFIBUS or INTERBUS. With TTL level, an interface module for conversion to RS422/RS485 is required. 4 units may be connected to an interface module.

8.10 Connecting the inputs INP3 / INP4 15



Selectable in configuration level as e.g. process variable x2, process variable x3, auxiliary variable z, ext. set-point or over ride control (OVC). The reference potential of the inputs is at C10.

8.11 Connecting the output OUT3 16

Depending on the version, OUT3 is a logic or continuous output (**550**). The logic signal is 0 / >20 mA (load ≤600 Ω) or 0 / >12 V (load ≥600 Ω). The signals are available, see page 28.

The function can be selected with configuration code **550**. By means of code **555**, the output can be connected to a post processing (e.g. linearisation).

8.12 Versions with integrated supply voltage

The supply voltage can be used only for energization of a 2-wire transmitter or for energization of max. 4 control inputs. The supply voltage is potential-free and can also be used for energizing inputs INP3 ... INP6 or for other units. Selection of supply voltage or digital inputs is by S.I.L. switches (see figure opposite).

	Transmitter supply voltage	Digital input
①	Position T	Position D
②	open	closed (D)
③	closed (T)	open

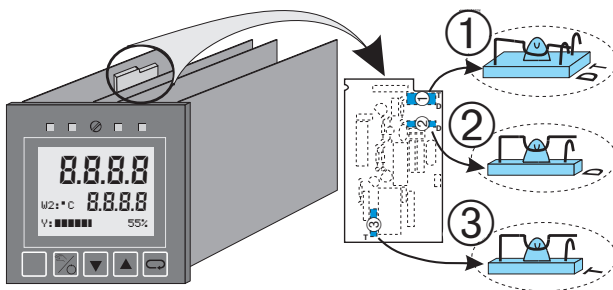

The supply voltage is only applied to terminals A12 and A14 with INP1 configured for **current** or **thermocouple (E, J, K, S, T, Y, Z)** and the S.I.L. switches set for transmitter supply (factory setting)! With the S.I.L. switches set to digital input, the voltage is applied to terminals A1 and A4 independent of the configuration of input INP1. In this case, the voltage input of INP5 is not available.

Supply voltage for energization of digital input (e.g. di1...di4)

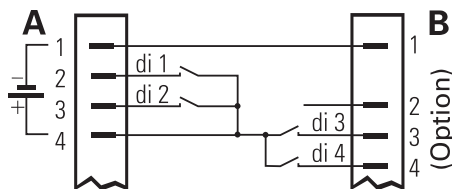

External use of the supply voltage

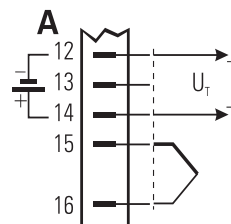

Connection of a 2-wire transmitter on example of INP1 or INP5

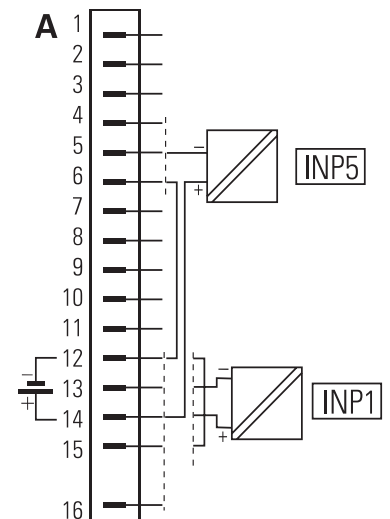

9. Operation (survey)



The user manual (order no. 9499 040 44811) is required for the complete operation.

9.1 The menus 1...3

Apart from the parameter and configuration words, the following dialogue words are used (Text1):

Text1	Signification
CBus CFrnt	PC communication via interface at terminals B12...B16 or connection on the unit front
Clear	The additional display selected at operating level is deleted (→ Mark)
Clock	Adjust the clock
Conf	Transition to configuration level
End	Return to the previous selection menu
Exit	Return to operating level (main display)
Hold	The displayed parameter is determined as standard indication.
Mark	The displayed parameter is stored as additional display at operating level (→ Clear)
More	The configuration level area described with MORE is accessible
OStar OStop	Self-tuning will be started or stopped
Para	Transition to parameter level
PRun PStop	Programmer will be started or stopped
PSet Pres	Programmer will be set to a specified program point or reset to the reset point
Quit	Return to operating level (main display) without storage of the values changed last

9.2 The operating level

The operating level comprises main display ① and extension ②. During the main display, automatic or manual operation can be selected (☐). With automatic, the set-point, and with manual, the correcting value can be adjusted directly (▲▼). In the extension, the number and sequence of displays is dependent of selected functions. Max. 12 parameters from the parameter level can be displayed (**Mark** ↔ **Clear**). Some of these parameters are directly adjustable (▲▼). A parameter can be displayed continuously with the **Hold** function. (Press ☐ < 3s → Select parameter (press ▲▼) → ☐ > 3s → Select **Hold** (Press ▲▼) → ☐). The extension can be left with **Exit** and ☐ or after a timeout of 60 s or with ☐. With ☐, the other operating mode is also selected.



If the set-point is set to '—' by means of ▼, the controller is switched off!!

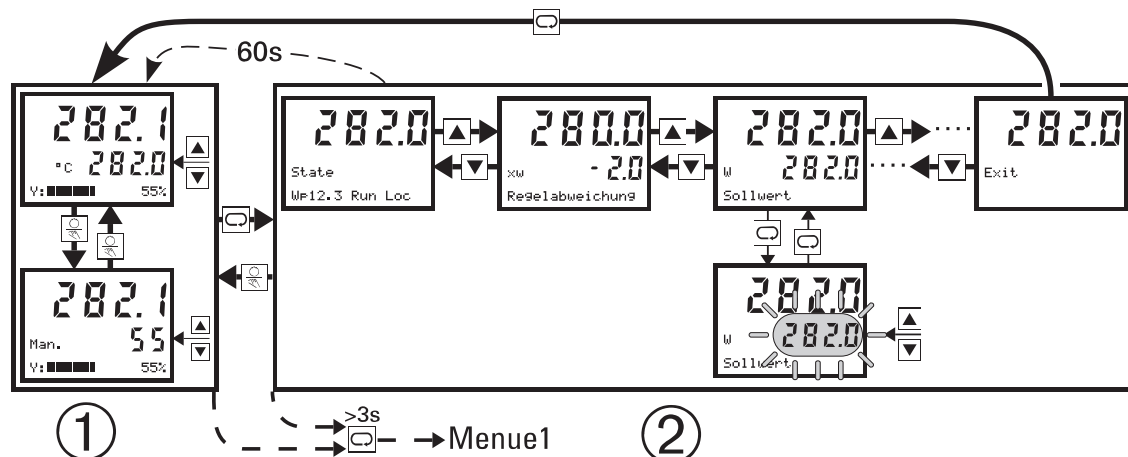

Menu 1 is always selectable at operating level: deletion of additional display (**Clear**), communication interface switch-over (**CBus** ↔ **CFrnt**) and starting (**OStar**) or stopping (**OStop**) the self-tuning, setting the clock (**Clock**), operate the programmer (**PRun** ↔ **PStop**; **Pres**; **PSet**) and transition to parameter level (**Para**).

Operation (survey)

Status display:

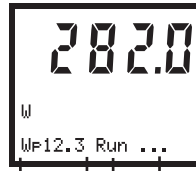

the extended operation of KS94, 'Text2' indicates the controller status. The following table shows the possible displays:

Set-point Symbol)	Meaning
.....	Internal set-point
We	External set-point
WF	Program set-point
xx.	Segment number
y	Program number
w2	2nd set-point

Status	Meaning
.....	No bandalarm and no programmer active
Band	Band width control has stopped programmer or set-point ramp.
End	End of program is reached
Grw	Set-point gradient is limiting the speed of change
Rset	Programmer in reset mode
Run	Programmer is running
Stop	Programmer has been stopped

Status	Meaning
...	KS94 in local mode (Front operation possible)
Rem	KS94 in remote mode (Front operation blocked)

9.3 Operating the programmer:

The programmer can be operated (run, stop, reset, preset) with menu 1, via digital inputs or via the interface (process management system).

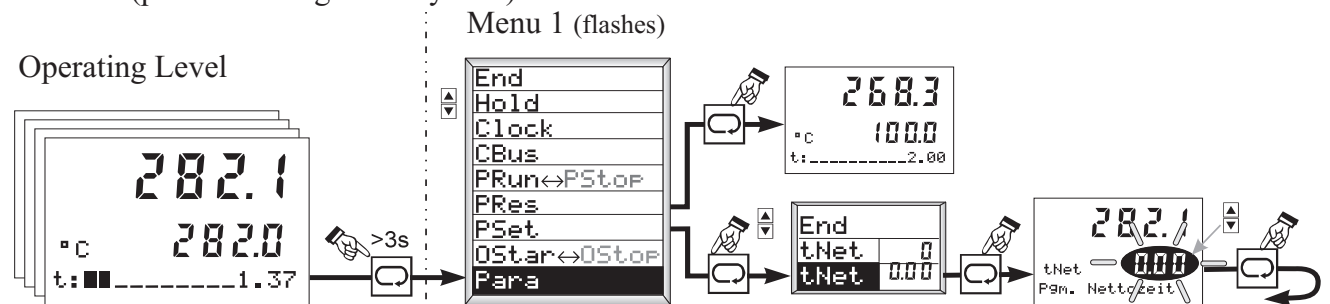

When entering the preset time (parameter setting: $Pmode = 1$) the time can be entered up to 99.59 in **hours . minutes**, or only in **hours** with longer times.

9.4 Calibration:



Calibration is only possible with the controller set to manual mode. Calibration from INP1/6 ($T_{YP} = 40$; Potentiometric transducer) is in two steps.

- Select $\times 0c$ → Press \square (C blinking) → set transducer to 0%, wait 6s and confirm with \square .
- Select $\times 100c$ → Press \square (C blinking) → set transducer to 100%, wait 6s and confirm with \square .

Manual calibration of INP6 is only possible with the DAC function switched off. With the DAC function switched on, automatic calibration is possible (→ DAC page 11).

- For selecting $YPCal$, press → \square (E blinks) change to 1 with \blacktriangle and acknowledge with \square → automatic calibration is started.

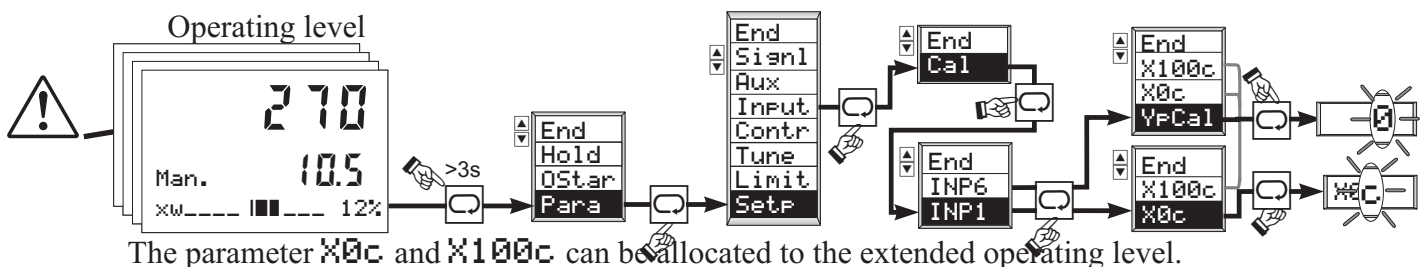

9.5 DAC – motor actuator monitoring (Digital Actor Control DAC®)

With all controllers with position feedback Yp, the motor actuator can be monitored for functional troubles.

CFunc = 08 = 3-point stepping controller with position feedback as a potentiometer

CFunc = 09 = continuous with position feedback as a potentiometer

CFunc = 12 = continuous with current feedback via Yp (INP6)

The system detects the following stepping controller errors:

- defective motor
- defective capacitor (wrong rotating direction),
- wrong phase followers
- defective force transmission at spindle or drive,
- excessive backlash due to wear
- jamming of the control valve e.g. due to foreign body

With the continuous controllers, monitoring if output signal and position feedback exceed a difference of 10 % after elapse of a 20 s filter time is provided. The DAC® function can be switched on or off at parameter setting level (DAC = 0/1). A detected trouble is indicated, the controller switches to manual mode and no pulses are output any more.



During Yp calibration, the DAC® function is activated! Otherwise, disabling would be detected when reaching the limits and the controller would be switched to “off” (r calibration).

9.6 Self-tuning (automatic optimization of control parameters)

After starting by the operator, the controller makes an attempt for optimization by determining the parameters for fast line-out at the set-point without overshoot from the process characteristics.

Optimization start:the operator can start the optimization attempt at any time (see opposite drawing).

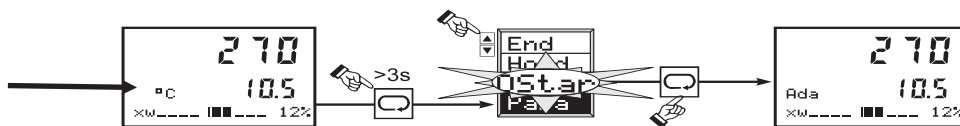

Preparation for self-tuning:

- PID, PI, PD or P control behaviour can be selected by the user by switching off Tn=0 or Tv=0 before self-tuning start.
- Determine which parameter set shall be optimized (POpt).
- Determine the output step change (dYOpt).
- Determine the stable correcting variable (YOptM).
- Determine the 'process-at-rest' mode (E.100 ; OCond)
- Is the set-point reserve (x-w) > 10% of W100-W0?

Self-tuning cancelation:

The operator can cancel the optimization attempt at any time. This is possible by pressing key (→controller switches to 'manual') or via **OSTOP** in menu1 (→ controller switches to 'automatic'). The controller continues operating with the **old** parameter values.

Optimization problems:

With process conditions which prevent successful optimization, the controller cancels the attempt for optimization (**Ada F** is displayed). The controller outputs are switched off to prevent the set-point from being exceeded. After self-tuning cancelation, controlling is continued with the **old** parameter values.

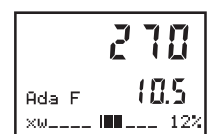

9.7 Parameter and configuration level

Menu 1 is always selectable at operating level: several operations (→ 7.2) and transition to parameter level (**Para**).

Menu 2 is always selectable at parameter level: selection of additional displays (**Mark**), return to parameter level (**End**), return to operating level (**Exit**), transition to configuration level (**Conf**).

Menu 3 is always selectable at configuration level: permitting the MORE area (**More**), return to configuration level (**End**), return to operating level without storage of the last changes (**Quit**) or with storage of the changes (**Exit**).

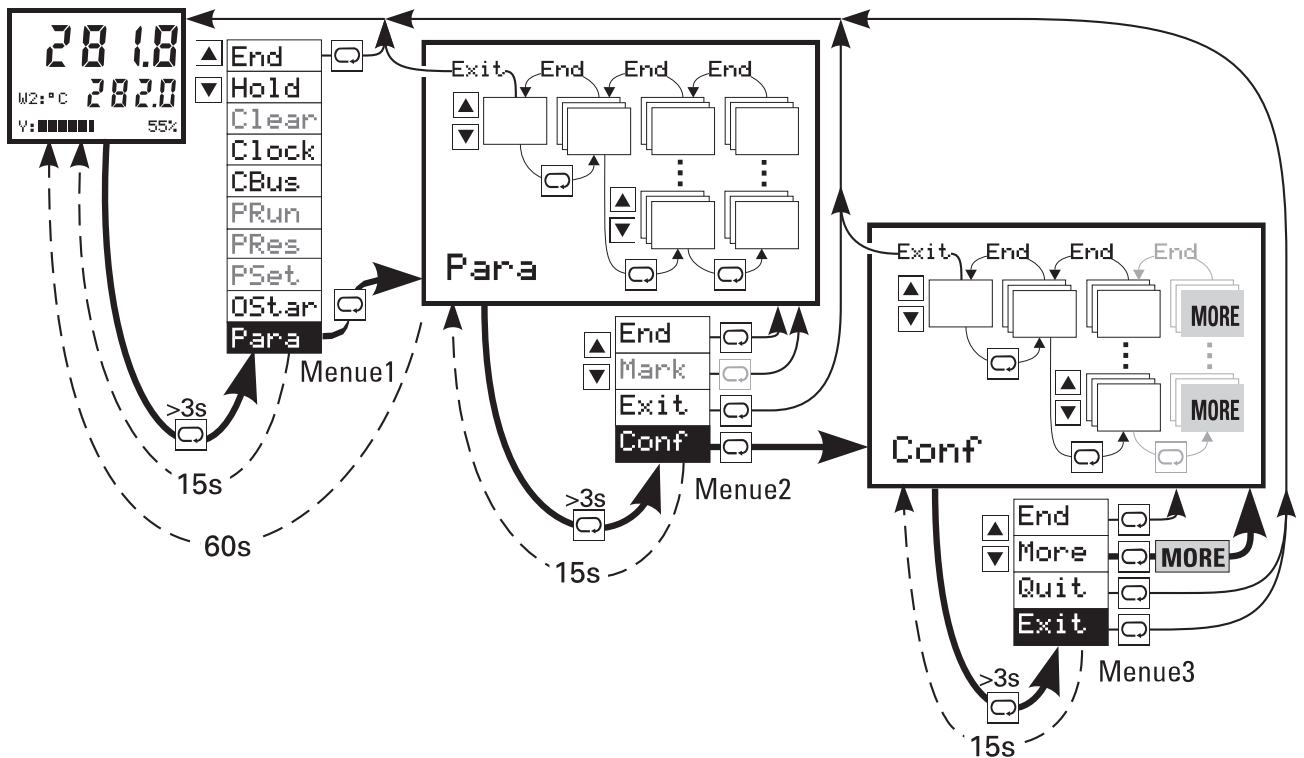

Value adjustment is as follows (parameter values / configuration codes):

Example for a single value

Example for combined data (e.g. C-codes)

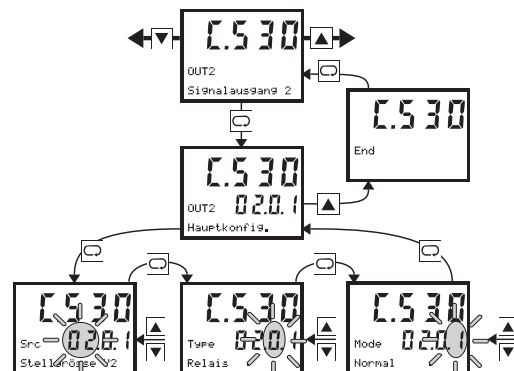
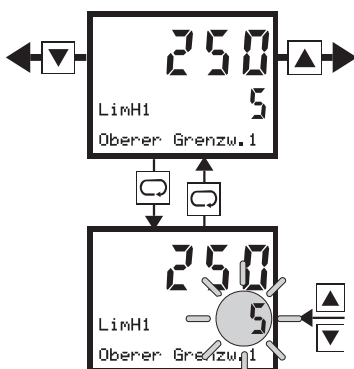

10. Configuration

10.1 General

The KS94 controller configuration for quick and easy function selection during subsequent operation is described in this section. During configuration, the required functions are selected from a large variety of available functions. The configuration determines the basic structure for solution of an application.



The configuration structure is designed so that determination of the required functions for a large number of applications is possible by adjustment of as few configuration words as possible. Moreover, the structure was designed flexible enough to permit additional configurations also for realization of special applications.

10.2 Basic structure

The first menu level permits selection of the main configuration group.

The user can be guided through all function configurations, or he can configure the specific functions required for his application directly.

For all 'complex' main groups, a two-level configuration concept which enables the user to select the 'correct' setting for his application by defining only one configuration word was determined. If necessary, special functions can be determined separately. For the 'normal user', however, the configuration words are preset to purposeful default values! For simplification, the hierarchic configuration dialogue is structured so that the user can and must adjust only the 'required' configuration words.

The user configuration dialogue is started via selector key  and 'increment' / 'decrement' keys , like with the other KS92/94 operating levels:

- Press the selector key to select menu items / input values / input positions within a 'level' and to change over to the next higher level at the end of a 'level'.

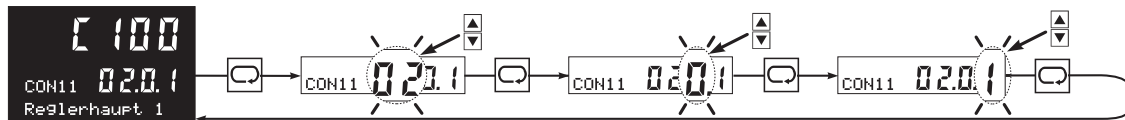

- Press the 'increment' / 'decrement' keys for returning to a lower level and for modification of input values.

The configuration structure is shown on the two following pages (16 and 17). All possible configuration words are listed. Configuration words which are irrelevant for a function are not displayed during the dialogue!

Switch-over to a selection menu is possible from anywhere during configuration by pressing key  >3s.

End: Return to configuration level
More: Activating the More function
Quit: Return to operating level
 (configuration changes are not effective)
Exit: Return to operating level (configuration changes are effective and the controller is re-initialized).

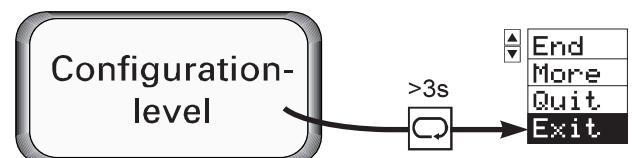

Fig.1: Configuration-Overview

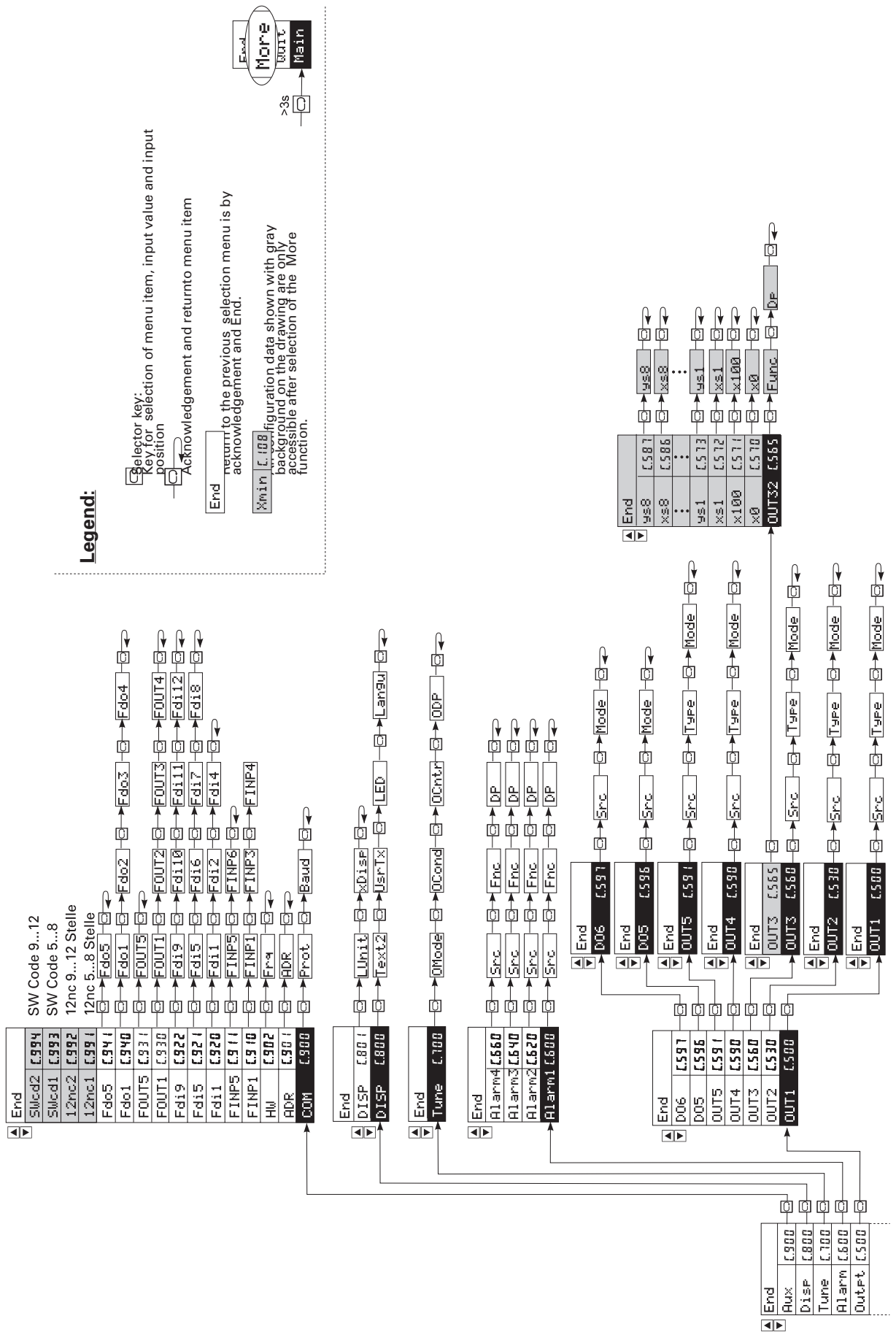
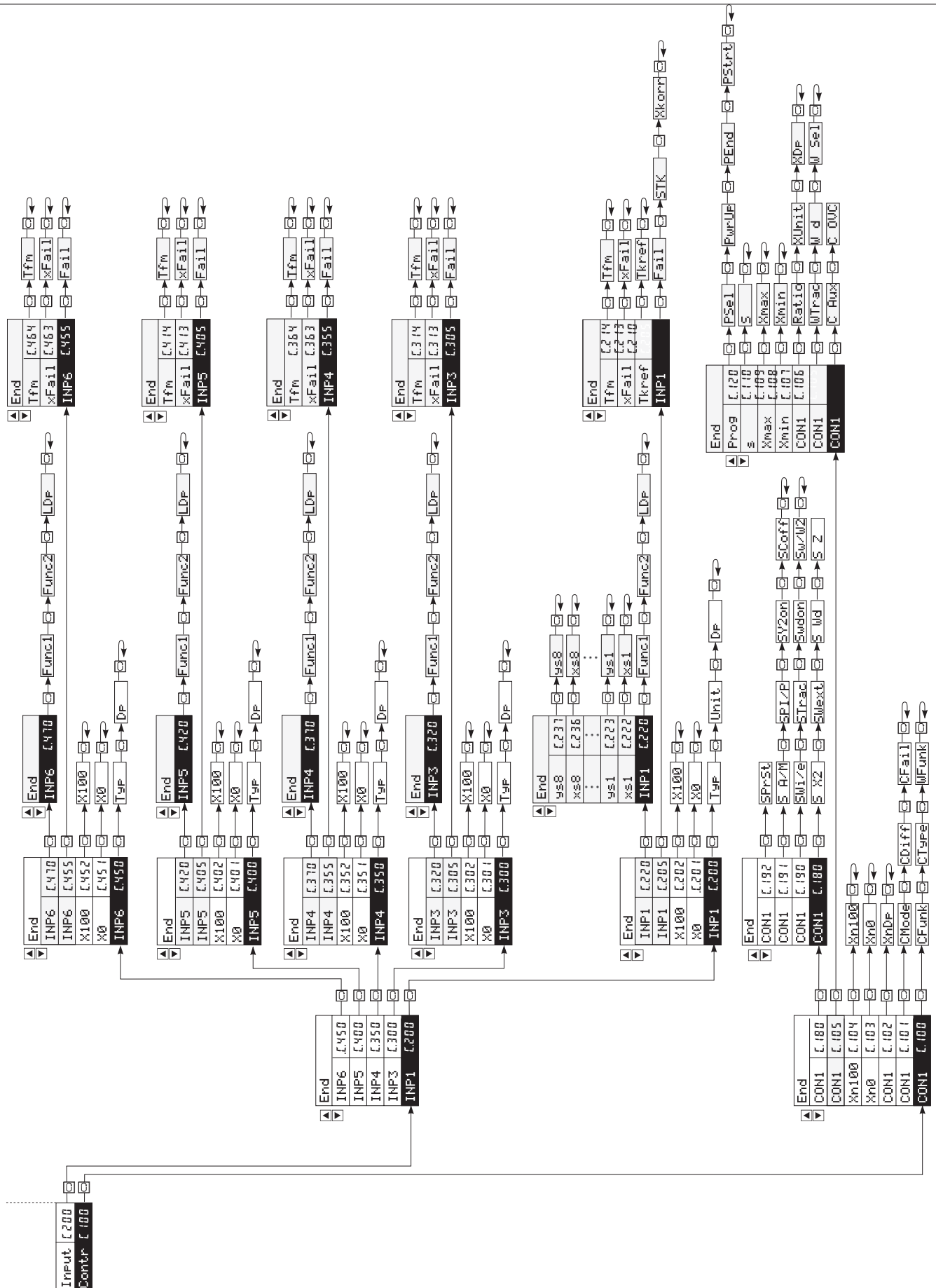

Fig.2: Configuration-Overview



10.3 Main groups

The following main configuration groups are available for KS9x controller configuration:

Contr	Controller function	C.100	...	C.139	→ page 19
Source	Input allocation	C.180	...	C.192	→ page 21
Input	Input function	C.200	...	C.487	→ page 23
Output	Output function	C.500	...	C.597	→ page 27
Alarm	Alarm function	C.600	...	C.660	→ page 31
Tune	Self-tuning	C.700			→ page 32
Disp	User interface	C.800			→ page 32
Aux	Additional function	C.900	...	C.994	→ page 33

The main configuration groups are structured in a hierarchical order, whereby determination of a dialogue for prompting only the really relevant configurations is possible.

i ENGINEERING TOOL 'ET/KS 94'

Engineering Tool ET/KS94 permits realization of all operations which are possible via the KS94 front panel on a PC, whereby controller configuration and parameter setting are facilitated considerably.

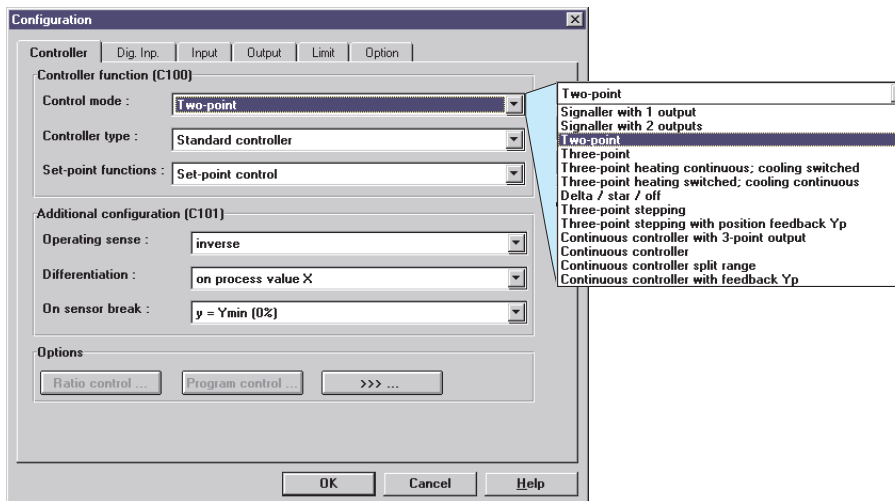

The engineering tool offers the following functions:

- Creation and modification of the parameter set
- Transmission of a parameter set to KS94
- Read-out of a parameter set from a KS94
- Long-term storage of various parameter sets on hard disk or floppy
- Display of operating data

Connection of PC and KS94 controller is via an RS232/TTL adaptor cable, which must be ordered separately (ordering information → see page 43 section 12). In conjunction with the 'SIM/KS 94' controller simulation, a graphic trend display of the real process data is available!

10.4 CONTR: Controller

This main group determines the controller structure and function, which is used as starting point for controller configuration for a particular application. The main controller configuration **C. 100** leads to an input and output pre-adjustment (**C. 180 .. C. 190**, **C.500 .. C.599**). This 'proposal' must always be checked before commissioning and corrected, if necessary. After determination of this word, no further settings are required for a large number of applications. Additional function adaptations are possible via configuration words **C. 105** and the following configurations.



Main controller configuration 1:

CFunc (Control behaviour)	CType (Controller type)	WFunc (Set-point function)
00: signaller 1 output 01: signaller 2 outputs 02: 2-pnt.controller 03: 3-pnt.controller (heating switching and cooling switching) 04: 3-pnt.controller (heating continuous and cooling switching) 05: 3-pnt.controller (heating switching and cooling continuous) 06: Δ/Y-off 07: 3-pnt.stepping 08: 3-pnt.stepping with Yp (INP6) 09: continuous with position controller 10: continuous 11: continuous split-range (only with Optim C; OUT1 and OUT3) 12: continuous with current feedback via Yp (INP6)	0: standard controller 1: ratio controller (→ C. 107) 2: 3-element controller $x_s = x1 + a \cdot (x2 - x3)$ 3: mean value $x_s = (1 - b) \cdot x1 + b \cdot x2$	0: set-point 1: set-point / cascade 2: programmer 3: set-point with ext. offset 4: set-point / cascade with internal offset 5: set-point / cascade with external offset 6: programmer with internal offset 7: programmer with external offset

Main controller configuration 2:



CMode (Output action)	CDiff (Differentiation)	CFail (Controller behaviour with main variable sensor break)
0: inverse 1: direct	0: differentiate Xw 1: differentiate X	0: neutral (controller outputs switched off) 1: Ypid = Ymin (0) 2: Ypid = Ymax (100) 3: Ypid = Y2 (adjustment via front panel not possible) 4: Ypid = Y2 (adjustment via front panel possible)

Configuration

More



Use of an auxiliary variable and external y limiting:

CAux (Auxiliary variable z via INP3/6)	COVC (Output limiting)
00: no 01: X+Z in conjunction with the process value without differentiation 02: X-dZ/dt in conjunction with the process value with differentiation in both directions 03: X+dZ/dt in conjunction with the process value with differentiation and positive change 04: X-dZ/dt in conjunction with the process value with differentiation and negative change 05: Y+Z in conjunction with the correcting variable without differentiation 06: Y-dZ/dt in conjunction with the correcting variable with differentiation in both directions 07: Y+dZ/dt in conjunction with the correcting variable with differentiation and positive change 08: Y-dZ/dt in conjunction with the correcting variable with differentiation and negative change	0: no external limiting 1: OVC+ 2: OVC-

More



Set-point functions:

(only with option C, Wext and not with 3-element controller)

WTrac (Behaviour of Wint when switching over from Wext to Wint with the w tracking input switched on)	dW (Type of set-point tracking.)	W Sel (MIN/MAX selection)
0: Set-point tracking 1: Process value tracking	0: additive 1: factor	0: no selection 1: Max selection Weff 2: Min selection Weff

More



Ratio functions: (only with ratio controller)

Ratio (Ratio control function)	XDP (Process value decimal point)
1: $(x1 + N0) / x2$ 2: $(x1 + N0) / (x1 + x2)$ 3: $(x2 - x1 + N0) / x2$	0: no digit behind decimal point 1: 1 digit behind decimal point 2: 2 digits behind decimal point 3: 3 digits behind decimal point

More



Span start X0: (only with ratio controller)
 Xmin:(min. process value limiting Xmin)
 Numeric value: -999 ... 9999
 Span end X100: (only with ratio controller)

More



Xmax:(max. process value limiting Xmax)
 Numeric value: -999 ... 9999 and Xmin Xmax

More



Factor for stoichiometric ratio s: (only with ratio controller)
 S:stoichiometric ratio
 Numeric value: 00.00 ... 99.99 (2 fixed digits behind decimal point)

More



Programmer configuration:
 (only with programmer configured)

Psel (Source for program selection)	PwrUP (Behaviour with mains recovery)	PEnd (Behaviour with program end)	Pstrt (Source for Run/Stop)
0: program selection via operation 1: program selection via control input	0: continue program 1: stop program and switch over to Wint 2: continue program after automatic research 3: continue program after successful automatic research otherwise switch over to Wint 4: continue program at the time mark of mains recovery	0: continue with following program 1: following program and reset (start required)	0: start/stop and reset together*. control with int/ext (without Option B) 1: start/stop and reset separate. (Option B)

*C.190; Swi/e select the source for int/ext-switching.

10.5 SOURCE: Input signal allocation

Input signal allocation is dependent of main controller configuration 'C.100'. this proposal must always be checked before commissioning and corrected, if necessary. Therefore, input signal allocation 'SOURCE' is no independent main item and considered as additional configuration of 'CONTR'.

Signal allocation analog signals:



S X2 (Signal source for X2 with ratio and three-element controller)	SWext (Signal source for Wext with controller with external set-point)	S dW (Signal source for W with controller with set-point offset)	S Z (Signal source for auxiliary variable)
0: X2 switched off 1: X2 of INP5 2: X2 of INP3	0: Wext switched off 1: Wext of INP5 2: Wext of INP6 3: Wext of INP4	0: dW switched off 1: dW of INP5 2: dW of INP6 3: dW of INP4	0: z switched off 1: z of INP3 2: z of INP6 3: z of INP4



Allocation of digital signals for set-point processing:

SWi/e (Set-point switch-over from internal to external) ¹⁾	STrac (Bumpless switch-over to int. set-point with int./ext. switch-over)	SdWon (Effective set-point offset)	Sw/W2 (Switch-over to set-point w2)
0: only internal set-point 1: W/Wext via front 2: di1=external set-point 3: di2=external set-point 4: di1= internal set-point 5: di2= internal set-point	0: no tracking ²⁾ 1: tracking on 2: di2 = tracking on 3: di12 = tracking on 4: di2 = tracking off 5: di12 = tracking off	0: no offset ²⁾ 1: offset on 2: di1 = offset on 3: di2 = offset on 4: di11 = offset on 5: di1 = offset off 6: di2 = offset off 7: di11 = offset off	0: no W2 ²⁾ 1: fixed to W2 2: di1 = W2 3: di2 = W2 4: di12 = W2 5: Timer = W2 6: di1 = W 7: di2 = W 8: di12 = W



Allocation of digital signals for the controller functions:

S A/M (Automatic / manual manual switch-over)	SPI/P (3.pnt.stepping controller: feedback off, otherwise PI / P switch-over)	SY2on (Output of safe correcting value)	SCoff (Switch-off controller)
0: auto/manual via front 1: fixed to manual 2: di1 = manual 3: di2 = manual 4: Backup run 5: di1 = auto 6: di2 = auto	0: PI fixed ²⁾ 1: fixed to P action 2: di1 = P action 3: di2 = P action 4: di1 = PI action 5: di2 = PI action	0: Y no Y2) ²⁾ 1: fixed to Y2 2: di1 = Y2 3: di2 = Y2 4: timer = Y2 5: di1 = Y 6: di2 = Y	0: controller on/off via front (W = '—') 1: controller fixed to off 2: di1 = controller off 3: di2 = controller off 4: timer= controller off 5: di1= controller on 6: di2= controller on

More



Allocation of digital signals for the programmer: (only with programmer configured)

SPrSt (Signal source for programmer run/stop)
0: Run/Stop: Front 1: Run/Stop: di4 2: Run/Stop: di4 and timer 1

1) With the programmer configured, switch-over is between internal and external program set-point.

2) Can be switched over via interfaces (e.g. engineering tool; operating data)

10.6 INPUT: inputs

The signal inputs for the previously selected controller configuration are determined in this main group. The signal inputs required for the selected controller function are displayed in the menu for configuration. As during control function configuration, a large number of applications can also be covered by determining the main configuration. At the second level, special cases can be matched and adjusted by additional, optional configuration. Max. 5 signal inputs are provided on KS94. Analog inputs INP1, INP5 and INP6 are always provided; INP3 and INP4 are optional inputs. All analog inputs (whether or not used for control) can be used for monitoring purposes (e.g. alarm processing).

10.6.1 Signal input 1 / INP1 (main variable x1)

Configuration is for main variable x1. This signal input is a universal input for which extensive functions can be configured.



Main configuration:

The main configuration word is used for determination of input sensor type and physical unit. Additional input configurations can be determined using the additional configuration.

	Type (Sensor type)	Unit (Unit)*	DP (Number of decimals)
Thermocouple:	Resistance thermometer:	0: at TYP	0: no decimal point
00: Type L 0 ... 900 °C	20: Pt 100 -99.9 ... 850.0 °C	30...40	1: 1 digit behind the decimal point
01: Type J 0 ... 900 °C	21: Pt 100 -99.9 ... 250.0 °C	1: °C	2: 2 digits behind the decimal point
02: Type K 0 ... 1350 °C	25: 2 x Pt 100 -99.9 ... 850.0 °C	2: °F	3: 3 digits behind decimal point
03: Type N 0 ... 1300 °C	26: 2 x Pt 100 -99.9 ... 250.0 °C		<i>only with type: 20 ... 40</i>
04: Type S 0 ... 1760 °C	Standard signals:		
05: Type R 0 ... 1760 °C	30: 0 ... 20 mA		
06: Type T 0 ... 400 °C	31: 4 ... 20 mA		
07: Type W 0 ... 2300 °C	32: 0 ... 10 V		
08: Type E 0 ... 900 °C	33: 2 ... 10 V		
09: Type B (0) ... 400 ... 1820 °C	Potentiometric transducer:		
	40: 0 ... 500 Ohm		

* Unit settings for scaling of TYP 00...26. With TYP 30...40 the value is fixed to 0. For this case the unit to be displayed will be configured by **C.88 f.**

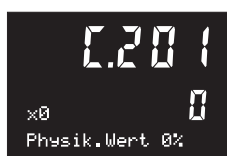

x0:

(physical value at 0%)
numeric value -999 ... 9999
select only with type = 30 ... 40



x100:

(physical value at 100%)
numeric value -999 ... 9999 , X0 ≠ X100!
select only with type = 30 ... 40

Configuration



Additional configuration:

Via the additional configuration, the default setting for the signal input can be changed or matched dependent of sensor type class.

Fail (Signal behaviour with sensor fault)	STk (Temperature compensation)	XKorr (Process value correction enable)
1: upscale(X100) 2: downscale(X0) 3: XFail (C.2 13)	0: not effective 1: internal TC 2: external TC (TC fixed in C.2 10!)	0: not effective 1: with process value correction (adjustable via parameters $\times 1_{in}$, $\times 1_{out}$, $\times 2_{in}$, $\times 2_{out}$)
Type: 00...26, 31, 40	type: 00 ... 09	
Non-selectable digits are marked by '0'		



Tkref:

(external TC)
numeric value: -99 ... 100 °C or °F
select only with type: 00...08 and STk = 2



XFail:

(substitute value with sensor error)
numeric value: -999 ... 9999



Tfm:

(filter time constant for input value processing)
numeric value: 0.0 ... 999.9



Optional configuration 1:

The optional configuration can be used to determine the functions for two signal pre-processing levels.

Func1, Func2 (Function selection for signal pre-processing)	LDF (decimal point for gain, Xeff and yki)
0: no function, signal is output directly 1: scaling (parameters: m,b) 2: linearization (segment points x_{s1}, y_{s1} ...) 3: filter (parameter: Tf) 4: square root extraction with factor (parameter: gain)	0: no decimal point 1: 1 digit behind the decimal point 2: 2 digits behind the decimal point 3: 3 digits behind decimal point

Linearization parameters:

More



The configuration parameters for linearization are stored as follows.

0.222	xs1	0.223	ys1	value pair 1
0.224	xs2	0.225	ys2	value pair 2
0.226	xs3	0.227	ys3	value pair 3
0.228	xs4	0.229	ys4	value pair 4
0.230	xs5	0.231	ys5	value pair 5
0.232	xs6	0.233	ys6	value pair 6
0.234	xs7	0.235	ys7	value pair 7
0.236	xs8	0.237	ys8	value pair 8



Note that the input values (x-values) must be entered in ascending order. (xs1<xs2<xs3...)

The range for these configuration words is within -999 and 9999 or '—' (switched off)!

- i** For limiting the number of parameters, these functions can be used only once during pre-processing levels 1 or 2! Linearization segment points which are not required can be switched off by setting '—'.

10.6.2 Signal input 3 / INP3 (ratio variable x2 or auxiliary variable z)

In this case, the signal is configured for ratio variable x2 or auxiliary variable z, provided that option p.c.b. C is fitted in the controller and the function was selected during controller configuration.



Main configuration:

Selection is only possible with option p.c.b. C provided.

Type (Sensor type)	DP (Number of digits behind the decimal point)
Standard signals:	0: no decimal point
30: 0 ... 20 mA	1: 1 digit behind the decimal point
31: 4 ... 20 mA	2: 2 digits behind the decimal point
	3: 3 digits behind decimal point

More



Additional configuration:

The additional configuration can be used for changing or matching the signal input default setting for the sensor type. Select only with type = 31 option p.c.b. C and ratio or auxiliary variable selected.

Fail (Signal behaviour with sensor error)
1: upscale (X100)
2: downscale (X0)
3: XFail (0.3 13)

Configuration

The other configuration words for INP3 are explained in section (see following table).

X0	C.301	see	C.201	
X100	C.302	”	C.202	
XFail	C.313	”	C.213	
Tfm	C.314	”	C.214	
optional configuration 1	C.320	”	C.220	without linearization (Func1/2: 2)

10.6.3 Signal input 4 / INP4 (variable x3, ext. set-point Wext, override control ovc+/-)

The signal for three-element variable x3 or the galvanically isolated external set-point Wext or the override control signal ovc+/- are configured with option p.c.b. C fitted in the controller and the function selected during controller configuration.

The configuration words for INP4 are explained in section and (see following table).

Main configuration	C.350	see	C.300	
X0	C.351	”	C.201	
X100	C.352	”	C.202	
Additional configuration	C.355	”	C.305	
XFail	C.363	”	C.213	
Tfm	C.364	”	C.214	
Optional configuration 1	C.370	”	C.220	
Optional configuration 2	C.371	”	C.221	
	C.372	”	C.222	
Linearization table				
	C.387		C.237	

10.6.4 Signal input 5 / INP5 (ratio variable x2, ext. set-point Wext)

The signal for ratio variable x2 or external set-point Wext is configured with option p.c.b. not fitted in the controller and the function selected during controller configuration. The configuration words for INP5 are explained in section and (see following table).

Main configuration	C.400	see	C.300	additional 0/2...10V (type: 32/33)
X0	C.401	”	C.201	
X100	C.402	”	C.202	
Additional configuration	C.405	”	C.305	
XFail	C.413	”	C.213	
Tfm	C.414	”	C.214	
Optional configuration 1	C.420	”	C.220	without linearization (Func1/2: 2)

10.6.5 Signal input 6 / INP6 (auxiliary variable Yp, feedback Yp)

The signal for the auxiliary variable Yp or for the position feedbackk is configured, if this was selected during controller configuration.

The configuration words for INP6 are explained in section and (see following table).

Main configuration	C.450	see	C.300	additional potentiometric transducer for Yp (type: 40)
X0	C.451	”	C.201	
X100	C.452	”	C.202	
Additional configuration	C.455	”	C.305	
XFail	C.463	”	C.213	
Tfm	C.464	”	C.214	
Optional configuration 1	C.470	”	C.220	without linearisierung (Func1/2: 2)

10.7 OUTPT: outputs

10.7.1 Signal output 1 / OUT1



Used for configuring the source of output OUT1. This signal output is a universal output which can be configured for extensive functions.

Main configuration:

Src (Signal source)	Type (Output stage)	Mode (Motor actuator output action)
00: output switched of	0: relay (switching)	0: not selectable
01: controller output Y1/Yout1	1: 0 ... 20 mA (continuous output)	1: direct / normally open
02: controller output Y2/Yout2	2: 4 ... 20 mA (continuous output)	2: inverse / normally closed
03: output Ypid	3: 0 / 20 mA (logic)	
04: position feedback Yp		
05: controlling deviation Xw		
10: process value Xeff		
11: X1		
12: X2		
13: X3		
20: set-point W		
21: external set-point Wext		
22: external offset dWe		
23: set-point Weff		
24: programmer set-point Wprg		
25: alarm 1 (limit1)		
26: alarm 2 (limit2)		
27: alarm3 (limit3)		
28: alarm 1 (limit4)		

Additional configuration Out1:

Via the options configuration, the functionality for a signal post-processing stage can be determined.

This configuration word is displayed only with the option enabled.

More



Func (Function selection for signal output processing)	DP (decimal point for xsi,x0,x100)
0: no function, signal is output without change (0%...100%)	0: no decimal point
1: scaling (reference values C.510 and C.511 are effective)	1: 1 digit behind decimal point
	2: 2 digits behind decimal point
	3: 3 digits behind decimal point

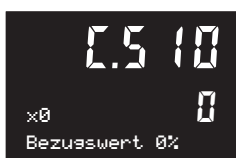

X0:

(physical value at 0%)
Numeric value -999 ... 9999

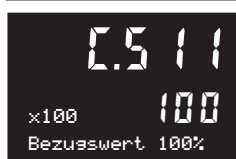

x100:

(physical value at 0%)
Numeric value -999 ... 9999

10.7.2 Signal output 2 / OUT2

Used for configuring the source of output OUT2. This signal output is a universal output and can be configured for extensive functions.

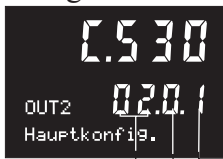

Main configuration:

Src (Signal source)	Type (Output stage)	Mode (Motor actuator output action)
00: output switched off 01: controller output Y1/Yout1 02: controller output Y2/Yout2 25: alarm1 (limit1) 26: alarm2 (limit2) 27: alarm3 (limit3) 28: alarm4 (limit4)	0: relay (switching)	0: not selectable 1: direct / normally open 2: inverse / normally closed

10.7.3 Signal output 3 / OUT3



Used for configuring the source of output OUT3. This signal output is a universal output and can be configured for extensive functions.

Main configuration:

Selection is only possible with option C fitted.

Src (Signal source)	Type (Output stage)	Mode (Motor actuator output action)
00: none (output switched off) 01: controller output Y1/Yout1 02: controller output Y2/Yout2 03: controller output Ypid 04: position feedback Yp 05: control deviation xw 10: process value xeff 11: process value x1	12: process value x2 13: process value x3 20: set-point Wint 21: ext. set-point Wext 22: ext. Offset dWe 23: set-point Weff 24: programmer Wprg	0: switched off 1: 0 ... 20 mA (continuous output) 2: 4 ... 20 mA (continuous output) 3: 0 / 20 mA (logic)
		0: not selectable 1: direct / normally open 2: inverse / normally closed

Additional configuration:

The optional configuration can be used for determining the functions for signal post-processing. This configuration word is displayed only with the option enabled.

More

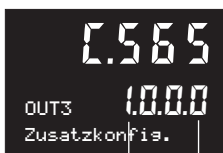

Func (Function selection for signal output processing)	DP (decimal point for xsi,x0,x100)
0: no function, signal is output directly (0%...100%) 1: scaling (reference values C.570 and C.571 are effective) 2: linearization (segment points xs1,ys1 ...)	0: no decimal point 1: 1 digit behind the decimal point 2: 2 digits behind the decimal point 3: 3 digits behind decimal point



x0:
(physical value at 0%)
numeric value -999 ... 9999



x100:
(physical value at 100%)
numeric value -999 ... 9999

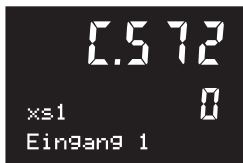

...

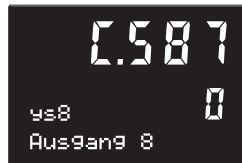

The configuration parameters for linearization are stored as follows.

0.572	xs1	0.573	ys1	value pair 1
0.574	xs2	0.575	ys2	value pair 2
0.576	xs3	0.577	ys3	value pair 3
0.578	xs4	0.579	ys4	value pair 4
0.580	xs5	0.581	ys5	value pair 5
0.582	xs6	0.583	ys6	value pair 6
0.584	xs7	0.585	ys7	value pair 7
0.586	xs8	0.587	ys8	value pair 8



Note that the input values (x-values) must be entered in ascending order.
($x_{s1} < x_{s2} < x_{s3} \dots$)

The range for these configuration words is within -999 and 9999 or '——' (switched off)!

10.7.4 Signal output 4 / OUT4



Used for configuring the source of output OUT4. This signal output can be configured for extensive functions.

Main configuration:

Src (Signal source)	Type (Output stage)	Mode (Actuator output action)
00: output switched off	0: relay (switching)	0: not selectable
01: controller output Y1/Yout1		1: direct / normally open
02: controller output Y2/Yout2		2: inverse / normally closed
25: alarm 1 (limit1)		
26: alarm 2 (limit2)		
27: alarm 3 (limit3)		
28: alarm 4 (limit4)		
29: programmer output 1		
30: programmer output 2		
31: programmer output 3		
32: programmer output 4		
33: program end		

Configuration

10.7.5 Signal output 5 / OUT5

Used for configuring the source of output OUT1.. This signal output can be configured for extensive functions.



Main configuration:

Src (Signal source)		Type (Output stage)	Mode (Actuator output action)
00: output switched off	30: programmer output 2	0: relay (switching)	0: not selectable 1: direct / normally open 2: i nverse / normally closed
01: controller output Y1/Yout1	31: programmer output 3		
02: controller output Y2/Yout2	32: programmer output 4		
25: alarm 1 (limit1)	33: program end		
26: alarm 2 (limit2)			
27: alarm 3 (limit3)			
28: alarm 4 (limit4)			
29: programmer output 1			

10.7.6 DO5,6 (digital control outputs)

Additional digital control outputs are configured!

Main configuration:



(digital control signal DO5)

Selection is possible with option C fitted.

Src (Digital control signal DO5)	Mode (Actuator output action)
00: output switched off	0: not selectable
01: controller output Y1	1: direct / normally open
34: status automatic=0 / manual=1	2: inverse / normally closed

Main configuration:



(Digital control signal DO6)

Selection is possible with option C fitted.

Src (Digital control signal DO6)	Mode (Motor actuator output action)
00: output switched off	0: not selectable
02: controller output Y2	1: direct / normally open
35: status external=0 / internal=1	2: inverse / normally closed

10.8 ALARM: alarms

10.8.1 Alarm 1 / (limit 1)

The function for alarm 1, (output via output OUT 4) is configured.



Main configuration:

Src (Alarm signal source)		Fnc (Alarm function)	Df (Decimals for alarm limits)
00: no source	11: Ypid	0: no alarm (don't care)	0: no decimal point
01: Xeff	12: OVC	1: sensor fail	1: 1 digit behind the decimal point
02: Xw*	13: WMIN/MAX (Wsel)	2: sensor fail or measurement value alarm	2: 2 digits behind the decimal point
03: x1	14: INP1	3: sensor fail or measurement value alarm with suppression with set-point switch-over or start-up	3: 3 digits behind the decimal point
04: x2	16: INP3	4: measurement value alarm	
05: x3	17: INP4	5: measurement value alarm with suppression with set-point change or start-up	
06: auxiliary variable z	18: INP5	6: Bus error (PROFIBUS-DP)	
07: Wext	19: INP6		
08: Δw	20: program time (net)		
09: Weff	21: program time (gross)		
10: Yp	22: program rest time		
	23: Status PROFIBUS-DP		
	24: faulty actor		

*Limit comparator (referred to set-point), all other versions are fitted with limit contact.

10.8.2 Alarm 2 (limit 2)

The function for alarm 2 (output via OUT 5) is configured.

Main configuration **C.620** see **C.600**

10.8.3 Alarm 3 (limit 3)

The function for alarm 3 (output via OUT 1) is configured.

Main configuration **C.640** see **C.600**

Selection is possible with OUT1 configured as alarm output.

10.8.4 Alarm 4 (limit 4)

The function for alarm 4 (output via OUT 2) is configured.

Main configuration **C.660** see **C.600**

Selection is possible only with OUT2 configured as alarm output

Configuration

10.9 TUNE:self-tuning



The type of controller self-tuning and the type of controlled self-tuning can be adjusted!

Main configuration:

OMode (Controller self-tuning)	OCond (Process-at-rest mode)	OCntr (Controlled self-tuning mode)	ODP (Decimals for OCntr)
0: Standard	0: grad = 0 1: grad < 0 with inverse controller or grad > 0 with direct controller 2: grad ≠ 0	0: no function 1: selectable control / disturbance behaviour 2: switch-over via operation 3: switch-over via control input 4: switch-over controlled by Weff 5: switch-over controlled by Xeff 6: switch-over controlled by Ypid 7: switch-over controlled by X-W	0: no decimal point 1: 1 digit behind the decimal point 2: 2 digits behind the decimal point 3: 3 digits behind the decimal point

10.10 DISP: User interface for operation



Configuration of display function signification via front panel

L1 process operation:

Text2 (Signification of display text2)	UsrTx (User text selection)	LED (Front LED function)	Langu (Language selection of text displays)
0: Y (correcting variable display) bargraph (-100% ...) 0% ... +100% 1: Xw (control deviation) bargraph -10% ... 0% ... +10% span 2: Tprog bargraph (elapsed program time) 0 ... tmax 3: Status display	0: no user text 1: user text via control input 2: user text via function statuses	0: logic output levels Y1, Y2, LIM1, LIM2 1: logic output levels LIM1...LIM4 2: programmer control outputs D1 ... D4 3: logic output levels LIM1, Y1, Y2, LIM2 4: PROFIBUS-DP errors 5: logic output levels Y2, Y1, LIM1, LIM2 6: logic output levels LIM1, Y2, Y1, LIM2	0: German 1: English 2: French



Unit display:

LUnit (Unit selection for text 1)	xDISP (select process value for disp.)	wDISP (select set-point for disp.)
00: no unit 01: °C 02: °F 03: % 04: mbar 05: bar 06: t/h 07: m3/h 08: 1/min 99: freely selectable Engineering tool necessary	0: Process value = xeff 1: Process value = x1 2: Process value = x2 3: Process value = x3	0: set-point disp. = Standard 1: set-point disp. = Weff

10.11 AUX: Additional functions

The interface function and operating frequency for suppression of interference on inputs are configured.

10.11.1 COM (serial interface)



Main configuration:
(ISO1745, PROFIBUS)
Only with HW option B

Prot (Interface protocol)	Baud (Baud rate)*
0: ISO174	00: not adjustable
	01: 2400 Bd
	02: 4800 Bd
	03: 9600 Bd
	04: 19200 Bd

*PROFIBUS: automatic baud rate detection



Addr (Interface address)
ISO1745
0 ... 99 (default 0)
PROFIBUS-DP
1...128 (default 128)

10.11.2 Hardware

The hardware-related functions are configured.



Main configuration:
Operating frequency for suppression of interference on inputs is configured.

Frq (Mains frequency)
0: 50 Hz
1: 60 Hz

10.11.3 Forcing signal input



All configuration for forcing ar only present by PROFIBUS-DP

FINP1 (Forcing input 1)	FINP3 (Forcing input 3)	FINP4 (Forcing input 4)
0: Controller value	0: Controller value	0: Controller value
1: Forcing	1: Forcing	1: Forcing



FINP5 (Forcing input 5)	FINP6 (Forcing input 6)
0: Controller value	0: Controller value
1: Forcing	1: Forcing

10.11.4 Forcing digital input

10.11.5



Fdi1 (Forcing digital input 1)	Fdi2 (Forcing digital input 2)	Fdi4 (Forcing digital input 4)
0: Controller value	0: Controller value	0: Controller value
1: Forcing	1: Forcing	1: Forcing

Configuration

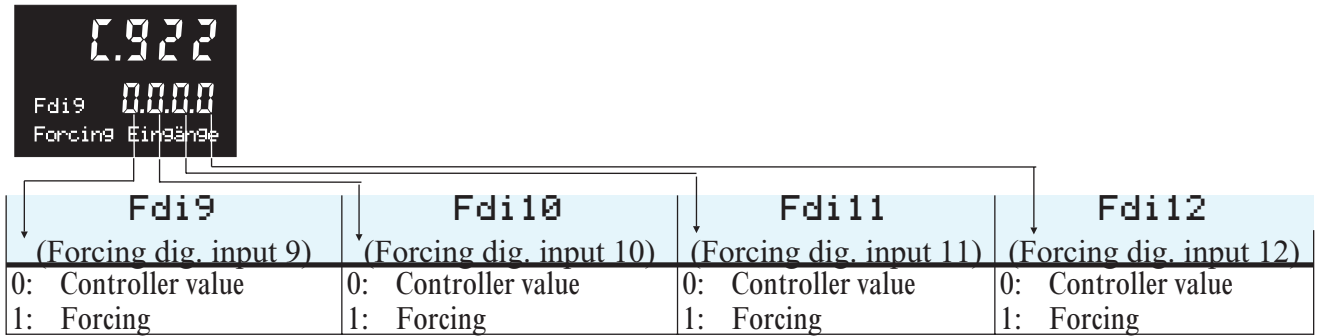
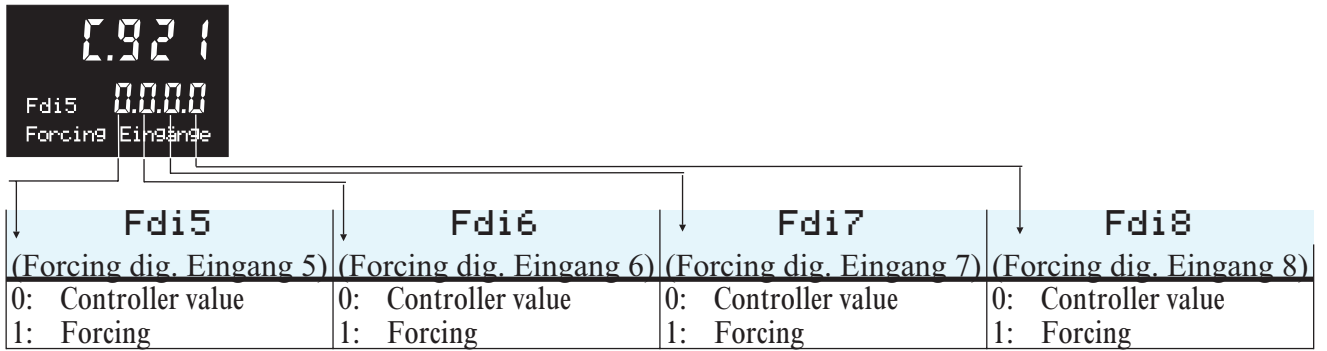

10.11.6 Forcing signal output

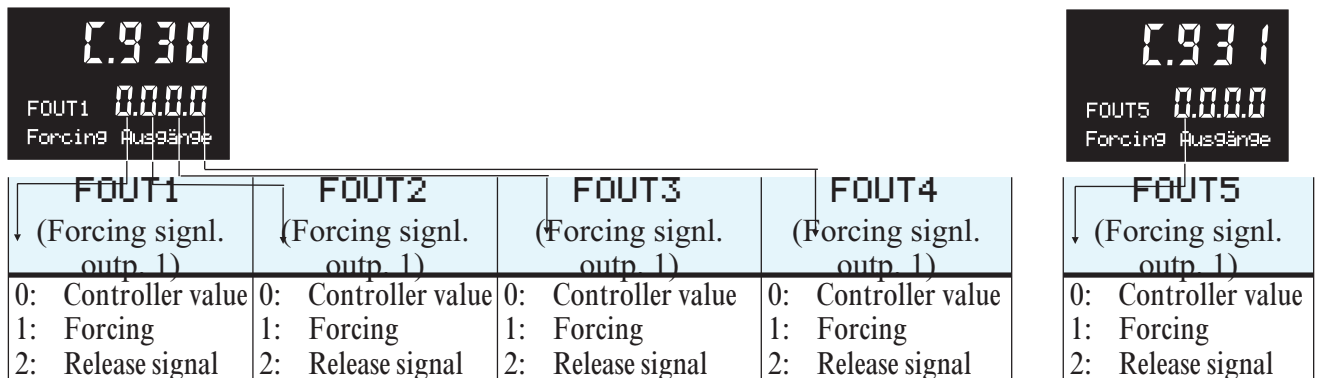

10.11.7 Forcing digital output

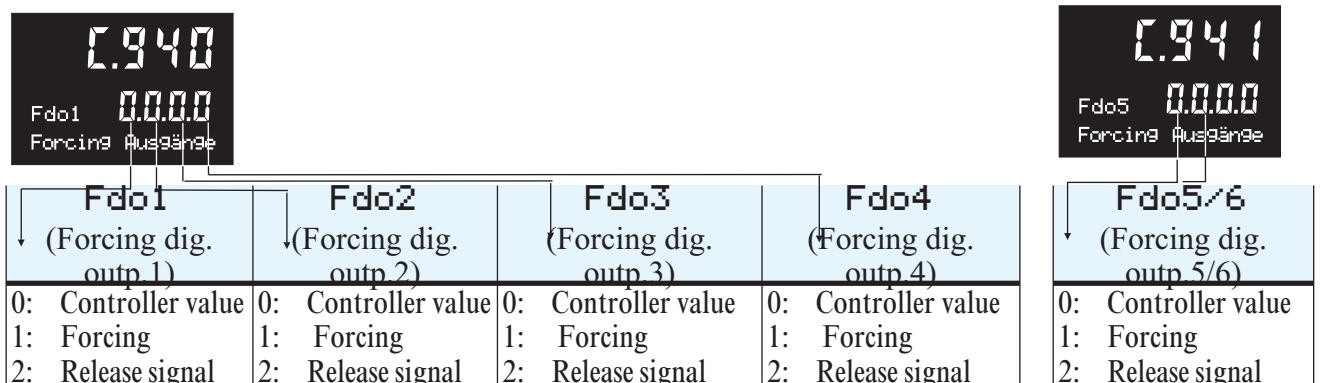

10.11.8 Hard-/Software Codenumber

The following configuration dates are not changeable. They show the hardware version (C.991 u. C.992) and the software version (C.993 u. C.994) of the instrument.

Example: 9407 923 31201

Example: 4012 157 25320

More

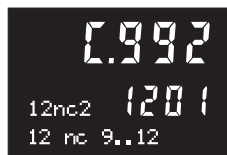
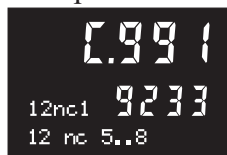

10.12 Examples of configuration

Block diagram	Configuration, different from default					
9407-9x4-xxxxx <p>Continuous controller 1 xw- alarm, 2 process value alarms</p>	C.100	CFunc = 10 (continuous)	C.590	Src = 25 (alarm 1)		
		CTyp = 0 (standard controller)	C.591	Src = 26 (alarm 2)		
		WFunc = 0, 1, 4 or 5	C.600	Src = 02 (xw-alarm)		
	C.200	Typ = sensor type	C.660	Src = 03 (process value x1)		
	C.500	Src = 01(controller output y1)	C.640	Src = 03 (process value x1)		
	C.530	Src = 28 (alarm 4)				
9407-9xx-xxxxx <p>2-pnt. controller + 2 process value alarms</p>	C.100	CFunc = 02 (2-pnt.controller)	C.591	Src = 26 (alarm 2)		
		CTyp = 0 (standard controller)	C.660	Src = 03 (process value x1)		
		WFunc = 0, 1, 4 or 5	C.640	Src = 03 (process value x1)		
	C.200	Typ = sensor type				
	C.500	Src = 01(controller output y1)				
	C.590	Src = 25 (alarm 1)				
9407-9xx-xxxxx <p>3-pnt. stepping controller + process value alarm</p>	C.100	CFunc = 03 (3-pnt.stepping)	C.591	Src = 26 (alarm 2)		
		CTyp = 0 (standard controller)	C.620	Src = 03 (process value x1)		
		WFunc = 0, 1, 4 or 5				
	C.200	Typ = sensor type				
	C.530	Src = 01 (controller output y1)				
	C.590	Src = 02 (controller output y2)				
9407-9x4-xxxxx <p>Ratio controller (continuous) 1 xw- alarm, 2 process value alarms</p>	C.100	CFunc = 10 (continuous)	C.530	Src = 28 (xw-alarm)		
		CTyp = 1 (ratio controller)	C.590	Src = 25 (alarm 1)		
		WFunc = 0, 1, 4 or 5	C.591	Src = 26 (alarm 2)		
	C.180	S X2 = 1 (INP5)	C.600	Src = 02 (xw-alarm)		
	C.200	Typ = sensor type	C.660	Src = 01 (xeff)		
	C.500	Src = 01(controller output y1)	C.640	Src = 03 (process value x1)		
9407-9x4-1x2xx <p>Programmer (continuous) 1 xw- alarm</p>	C.100	CFunc = 10 (continuous)	C.530	Src = 28 (alarm 4)		
		CTyp = 1 (standard controller)	C.591	Src = 33 (program end)		
		WFunc = 3 (programmer)	C.600	Src = 02 (xw-alarm)		
	C.192	SPrSt = 1 (di4)				
	C.200	Typ = sensor type				
	C.500	Src = 01(controller output y1)				
9407-9x4-x1xxx <p>Continuous contr. 'split-range' 1 xw- alarm, 1 process value alarm</p>	C.100	CFunc = 11 (continuous split-range)	C.590	Src = 25 (alarm 1)		
		CTyp = 1 (standard controller)	C.591	Src = 26 (alarm 2)		
		WFunc = 0, 1, 4 or 5	C.600	Src = 02 (xw-alarm)		
	C.200	Typ = sensor type	C.660	Src = 03 (process value x1)		
	C.500	Src = 01(controller output y1)				
	C.560	Src = 02(controller output y2)				

Parameters

11. Parameters

11.1 General

This section gives a survey of the KS92/94 parameter data and general hints for parameter handling. The parameter operation and effect on the controller operation are described with the operating principle.

The parameter setting dialogue is realized via selector key  and 'increment' / 'decrement' keys , like at the other operating levels:

- Press the selector key to select menu items / input values within one level and to change to the next higher level.
- Press the 'increment' / 'decrement' keys to return to a lower level or to change input values.

The controller parameter structure is given on the following page. All parameters are listed. Parameters which are not relevant for a function (configuration-dependent) are not displayed!

A selection menu can be displayed anywhere at parameter level by pressing key  >3s.

End: return to parameter level

Mark: mark the selected parameter for display at 'extended' configuration level.

Exit: return to operating level.

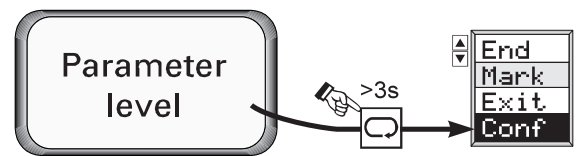

Conf: transition to configuration level.





11.1.1 Allocation of parameters to the 'extended operating level'



Up to 12 parameters can be allocated to the 'extended operating level' (see Fig.3:), whereby the controller operation is simplified, since changing over to parameter level whenever one of these parameters must be changed is omitted.

Allocation: select required parameter, press 'selection' key  during >3s (**Para** blinks)

Select Mark with 'up' key  and acknowledge with 'selection' key  (see Fig.3:).

Delete: select the required parameter at the extended operating level, press 'selection' key  during >3s (**Para** blinks) and acknowledge with 'up' key .

Select **Clear** and acknowledge with 'selection' key  (see Fig.4:).

Hold: The Hold function can be used for selecting a parameter from the extended operating level for being visible continuously. For this, select the required parameter at the extended operating level, press 'selection' key  during >3s (**Para** blinks) select Hold with 'up' key  and confirm with 'selection' key  (see Fig.4:).

Applications:

- During optimization, frequent access to defined parameters (Xp1, Xp2, Tn and Tv) is required.
- During commissioning, limit value (LimH1, LimH2, ...) or measurement value corrections must be changed frequently.
- With the parameter level disabled, access to the selected parameters is possible for the operator. Deleting a parameter from the 'extended operating level' must be done at this level (see Fig.4:)

Fig.3 : selecting a parameter

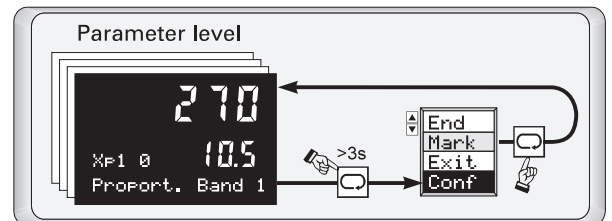
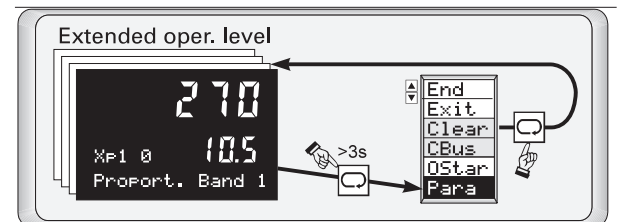
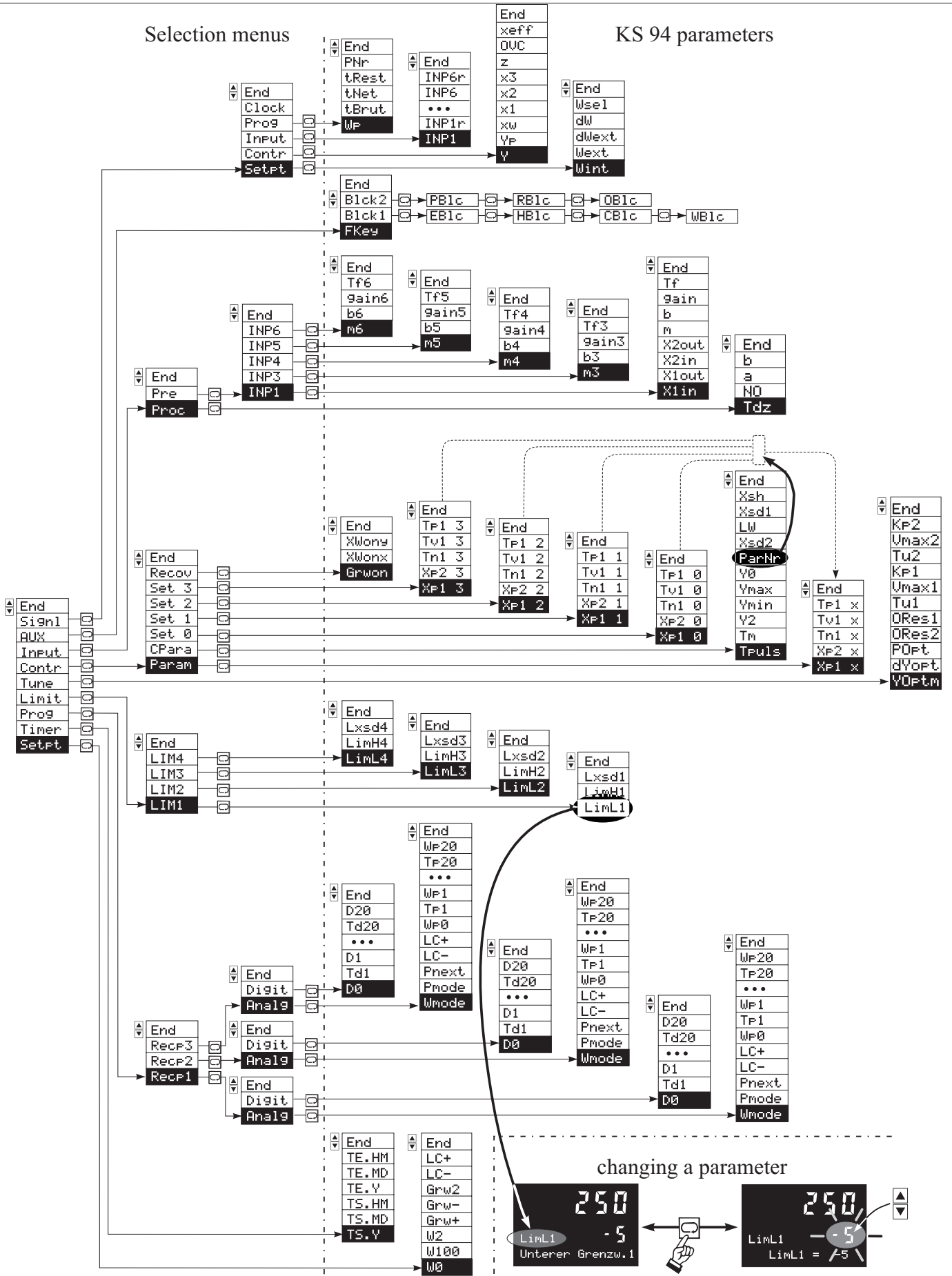

Fig.4: deleting a parameter





Parameters

11.2 Set-point function

Text 1	Description	Range	Default
SetPt	Set-point parameter		
LC+	Band width upper limit	0...9999	'_____' (switched off)
LC-	Band width lower limit	0...9999	'_____' (switched off)
W0	lower set-point limit for Weff	-999 ... 9999	0
W100	upper set-point limit for Weff	-999 ... 9999	100
W2	additional set-point	-999 ... 9999	100
Grw+	set-point gradient plus with W[w/min]	0.01 ... 99.99	'_____' (switched off)
Grw-	set-point gradient minus with W[w/min]	0.01 ... 99.99	'_____' (switched off)
Grw2	set-point gradient with W2[w/min]	0.01 ... 99.99	'_____' (switched off)

11.3 Time function

Text 1	Description	Range
Timer	Timer-parameters	
TS.Y	Start value: Year	0...255
TS.MD	Start value: Month and day	Month:1...12; Day: 1...31
TS.HM	Start value: Hour and minutes	Hour:0...23; Minutes: 0...59
TE.Y	Final value: Year	0...255
TE.MD	Final value: Month and day	Month:1...12; Day: 1...31
TE.HM	Final value: Hour and minutes	Hour:0...23; Minutes: 0...59

11.4 Programmer functions

RecP1				Programmer recipe 1			
Analog				Digital			
Text 1	Description	Range	Def.	Text 1	Description	Range	Def.
Wmode	Change mode	0: Ramp 1: Step 2: Ramp (Time priority)	0	D0	Reset value control output 1..4	0000..1111	0000
				Td1	Time segment 1	0...9999[min]	'_____'
				D1	control output 1..4 for segm. 1	0000..1111	0000
				...	-----	-----	-----
Pmode	Preset mode	0: Segment start 1: Program time	1	Td20	Time segment 20	0...9999[min]	'_____'
				D20	control output 1..4 for segm. 20	0000..1111	0000
Pnext	Successive program	1..3 or '_____'	'_'				
LC-	Band width lower limit	0...9999	'_'				
LC+	Band width upper limit	0...9999	'_'				
WF0	Reset value W0	-999...9999	0				
TP1	Time segment 1	0...9999 [min]	'_____'				
WP1	Set-point segment 1	-999...9999	0				
...							
TP20	Time segment 20	0...9999 [min]	'_____'				
WP20	Set-point segment 20	-999...9999	0				

RecP2 see programmer recipe 1

RecP3 see programmer recipe 1

11.5 Alarm function

Text 1	Description	Range	Default
LIM1	Alarm 1		
LimL1	Low limit	-999 ... 9999	'—' (switched off)
LimH1	High limit	-999 ... 9999	'—' (switched off)
Lxsd1	Switching difference	-999 ... 9999	0
LIM2	Alarm 2		
LimL2	Low limit	-999 ... 9999	'—' (switched off)
LimH2	High limit	-999 ... 9999	'—' (switched off)
Lxsd2	Switching difference	-999 ... 9999	0
LIM3	Alarm 3		
LimL3	Low limit	-999 ... 9999	'—' (switched off)
LimH3	High limit	-999 ... 9999	'—' (switched off)
Lxsd3	Switching difference	-999 ... 9999	0
LIM4	Alarm 4		
LimL4	Low limit	-999 ... 9999	'—' (switched off)
LimH4	High limit	-999 ... 9999	'—' (switched off)
Lxsd4	Switching difference	-999 ... 9999	0

11.6 Self-tuning

Text 1	Description	R/W	Range	Def.
Tune	Optimization			
YOptm	Correcting variable whilst process at rest	R/W	-105 ... 105	0
dYOpt	Step width during identification	R/W	5 ... 100	100
POpt	Parameter set to be optimized	R/W	0 ... 3	1
Tri#1	trigger point 1 (set 1 ↔ set 2)	R/W	-999 ... 9999 (Decimal point as configured in £.700 ; ODP)	
Tri#2	trigger point 2 (set 2 ↔ set 3)	R/W	-999 ... 9999 (Decimal point as configured in £.700 ; ODP)	
Tri#3	trigger point 3 (set 3 ↔ set 4)	R/W	-999 ... 9999 (Decimal point as configured in £.700 ; ODP)	
ORes1	Self-tuning result during heating	R	0: Cancellation (during optimization preparation) 1: Cancellation (wrong output action) 2: Finished (successful optimization; reversal point found) 3: Cancellation (process does not react or is too slow) 4: Cancellation (reversal point found; estimation unsafe) 5: Cancellation (reversal point not found; estimation unsafe) 6: Finished (optimization cancelled due to exceeded set-point risk; reversal point not reached so far; estimation unsafe) 7: Cancellation (correcting variable too low $\Delta Y < 5\%$) 8: Cancellation (set-point reserve too low)	
ORes2	Self-tuning result during cooling	R	0 ... 8 (see ORes1)	
Tu1	Delay time heating	R	000,0 ... 999,9 s	
Vmax1	Vmax heating	R	000,0 ... 999,9 /s	
KP1	Process amplification heating	R	000,0 ... 999,9	
Tu2	Delay time cooling	R	000,0 ... 999,9 s	
Vmax2	Vmax cooling	R	000,0 ... 999,9 /s	
KP2	Process amplification cooling	R	000,0 ... 999,9	

Parameters

11.7 Control algorithm

Text 1	Description	Range	Default
CPara	Controller parameters		
TPuls	Min. pulse length	0.1 ... 999.9 s	0.3
Tm	Actuator response time	10 ... 9999 s	30
Y2	Additional correcting value	-105 ... 105 %	0
Ymin	Min. correcting variable limiting	-105 ... 105 %	0
Ymax	Max. correcting variable limiting	-105 ... 105 %	100
Y0	Correcting variable working point	-105 ... 105 %	0
ParNr	Actual parameter set	0 ... 3	
Xsd2	Switching difference of additional contact	0.1 ... 999.9	1
LW	Trigger point separation of additional contact	-999 ... 9999	0
Xsd1	Switching difference of signaller	0.1 ... 999.9	1
Xsh2	Neutral zone ($X_w > 0$)	0.0 ... 999.9 %	0
Xsh1	Neutral zone ($X_w < 0$)	0.0 ... 999.9 %	0
Xsh	Neutral zone	0.2 ... 999.9 %	0.2
Set 0	Parameter set 0		
XP1 0	Proportional band 1	0.1 ... 999.9 %	100
XP2 0	Proportional band 2	0.1 ... 999.9 %	100
Tn1 0	Integral action time	0 ... 9999 s	10
Tv1 0	Derivative action time	0 ... 9999 s	10
T1 0	Duty cycle 1	0.4 ... 999.9 s	5
T2 0	Duty cycle 2	0.4 ... 999.9 s	5
Set1	Parameter set 1		
XP1 1	Proportional band 1	0.1 ... 999.9 %	100
XP2 1	Proportional band 2	0.1 ... 999.9 %	100
Tn1 1	Integral action time	0 ... 9999 s	10
Tv1 1	Derivative action time	0 ... 9999 s	10
T1 1	Duty cycle 1	0.4 ... 999.9 s	5
T2 1	Duty cycle 2	0.4 ... 999.9 s	5
Set2	Parameter set 2		
XP1 2	Proportional band 1	0.1 ... 999.9 %	100
XP2 2	Proportional band 2	0.1 ... 999.9 %	100
Tn1 2	Integral action time	0 ... 9999 s	10
Tv1 2	Derivative action time	0 ... 9999 s	10
T1 2	Duty cycle 1	0.4 ... 999.9 s	5
T2 2	Duty cycle 2	0.4 ... 999.9 s	5
Set3	Parameter set 3		
XP1 3	Proportional band 1	0.1 ... 999.9 %	100
XP2 3	Proportional band 2	0.1 ... 999.9 %	100
Tn1 3	Integral action time	0 ... 9999 s	10
Tv1 3	Derivative action time	0 ... 9999 s	10
T1 3	Duty cycle 1	0.4 ... 999.9 s	5
T2 3	Duty cycle 2	0.4 ... 999.9 s	5
Recov	Rapid Recovery (controller on)		
XwOnY	X-W limit value ($X-W < X_{wOnY} \rightarrow Y$ tracking)	0 ... 9999 *	'____'
XwOnX	X-W limit value ($X-W > X_{wOnX} \rightarrow X$ tracking)	0 ... 9999 *	'____'
GrwOn	set-point gradient with X tracking active	0,01 ... 99,99 /min	'____'

* Decimal point position of adjustment range as for main variable X1.

11.8 Input processing

11.8.1 Process value handling

Text 1	Description	Range	Default
Istw			
Tdz	Differentiation time constant for z	0 ... 9999 s	10
N0	Zero offset / ratio	-999 ... 9999	0
a	Factor a / 3-element control	-999 ... 9999	1
b	Factor b / mean value control	-999 ... 9999	0.5

11.8.2 Signal pre-processing

Text 1	Description	Range	Default
INP1	Signal processing for INP1		
X1in	Measurement value correction	-999...9999	0
X1out	Measurement value correction	-999...9999	0
X2in	Measurement value correction	-999...9999	100
X2out	Measurement value correction	-999...9999	100
m	Scaling: gradient m	0 ... 9.999	1
b	Scaling: offset b	-999 ... 9999	0
gain	Square root extraction: gain	0 ... 9.999	1
Tf	Filter: filter time constant	0 ... 999.9 s	0.5
INP3	Signal pre-processing for INP3		
m3	Scaling: gradient m	0 ... 9.999	1
b3	Scaling: offset b	-999 ... 9999	0
gain3	Square root extraction: gain	0 ... 9.999	1
Tf3	Filter: filter time constant	0 ... 999.9 s	1
INP4	Signal processing for INP4		
m4	Scaling: gradient m	0 ... 9.999	1
b4	Scaling: offset b	-999 ... 9999	0
gain4	Square root extraction: gain	0 ... 9.999	1
Tf4	Filter: filter time constant	0 ... 999.9 s	0.5
INP5	Signal processing for INP5		
m5	Scaling: gradient m	0 ... 9.999	1
b5	Scaling: offset b	-999 ... 9999	0
gain5	Square root extraction: gain	0 ... 9.999	1
Tf5	Filter: filter time constant	0 ... 999.9 s	0.5
INP6	Signal processing for INP6		
m6	Scaling: gradient m	0 ... 9.999	1
b6	Scaling: offset b	-999 ... 9999	0
gain6	Square root extraction: gain	0 ... 9.999	1
Tf6	Filter: filter time constant	0 ... 999.9 s	0.5

Parameters

11.9 Miscellaneous

Text 1	Description	Range	Def.	
Aux	General			
Fkey	Function of front panel key  .	0: no function 1: automatic / manual 2: Wext / Wint	1	
Blck1	EBloc	extended operating level	0: free 1: blocked 2: blocked by di1 3: blocked by di2	0
	HBloc	auto/man- key	0: free 1: blocked 2: blocked by di1 3: blocked by di2	0
	CBloc	controller off	0: free 1: blocked 2: blocked by di1 3: blocked by di2	0
	WBloc	setpoint	0: free 1: blocked 2: blocked by di1 3: blocked by di2	0
Blck2	PBloc	programmer preset	0: free 1: blocked 2: blocked by di1 3: blocked by di2	0
	RBloc	programmer run/stop/reset	0: free 1: blocked 2: blocked by di1 3: blocked by di2	0
	OBloc	selftuning	0: free 1: blocked 2: blocked by di1 3: blocked by di2	0

11.10 Signals

Signl	Description	Range	Def.
SetPt	Setpoint signals		
Wint	Internal set-point		
Wext	External set-point		
dWext	External correction		
dW	Set-point offset	-99,9 ... 999,9	0
Wsel	Min/max set-point		
Contr	Controller signals		
Y	Correcting value		
YF	Position feedback		
xw	Control deviation		
x1	Main input x1		
x2	Auxillary input x2		
x3	Auxillary input x3		
z	Auxillary variable		
OVC	External correcting variable limiting		
xeff	Effectiv process value		
Input	Input signals		
INP1	Input 1		
INP1r	Raw measure 1		
...			
INP6	Input 6		
INP6r	Raw measure 6		
Prog	Programmer signals		
WP	Programmer setpoint		
tBrut	Brutto time (inc. all pause times)		
tNet	Netto time (without pause times)		
tRest	Rest time		
PNr	Programmer no.	1 ... 3	1
Clock	Current time		

12. Versions



		9	4	0	7	9					1	
	KS 94											
	KS 94 with supply voltage											
Basics	90...250 VAC 4 Relais (OUT1, OUT2, OUT4, OUT5)											
	Universal version continuous/switching 3 relays and 1 current/logic output (OUT1, OUT2, OUT4, OUT5)											
	24 VUC 4 Relais (OUT1, OUT2, OUT4, OUT5)											
	24 VUC Universal version continuous/switching 3 relays and 1 current/logic output (OUT1, OUT2, OUT4, OUT5)											
Option B (Interface)	No interface											
	TTL interface with 5 control inputs (di3...di7), 4 control outputs (do1...do4)											
	RS422/485 interface with 5 control inputs (di3...di7), 4 control outputs (do1...do4)											
	PROFIBUS-DP interface with 5 control inputs (di3...di7), 4 control outputs (do1...do4)											
	INTERBUS, 5 control-inputs (di3...di7), 4 control-outputs (do1...do4)											
Option C (Supplements)	No additional functions											
	2 additional inputs (INP3, INP4), 1 additional output (OUT3), 5 control-inputs (di8...di12) 2 control-outputs (do5, do6)											
	1 additional output (OUT3)											
Extrafunctions	No additional functions											
	With measurement value correction											
	With measurement value correction and programmer											
Preconfiguration	Standard (to be configured by the customer)											
	2-point controller											
	3-point stepping controller											
	Continuous controller (current output necessary)											
	3-point controller (Logik/Relais current output necessary)											
	3-point stepping controller as 3-component controller (only with additional inputs INP3, INP4)											
	Continuous controller as 3-component controller (only with additional inputs INP3, INP4)											
	Adjustment as desired											

13.

13.1 Input and output allocation with pre-configured units

The signal (e.g. X1, Y1, alarms) allocation to the inputs and outputs for the relevant pre-configuration (factory setting) is given in the following table. Allocation can be altered at any time via front panel or interface and should be corrected before commissioning, if necessary.

Order numbers and functions for pre-configured units								
	9407-92(0;3;7)-xxx1x Two-point controller (relay output)	9407-92(1;4;8)-xxx1x Two-point controller (logic output)	9407-92(0;3;7)-xxx2x Three-point stepping controller	9407-92(1;4;8)-xxx2x Three-point stepping controller	9407-92(1;4;8)-xxx3x Continuous controller	9407-92(1;4;8)-xxx4x 3<%/6-2>-point contr. (‘heating’ = logic; ‘cooling’ = relay)	9407-92(3;7)-xxx5x 3-pnt. stepping controller; 3-element controller	9407-9X(4;8)-xxx6x Continuous, 3-element controller
Inputs								
INP1	X1							
INP3	-			X2		-	X2	
INP4				-			X3	
INP5	X2; Wext; Wd			Wext		X2; Wext; Wd	-	
INP6	auxiliary variable ‘Z’						-	
di1	W/Wext							
di2	Auto/man							
di3	Local / remote							
di4	Programmer start / stop							
di5	Programmer reset							
di6	Program selection 1							
di7	Program selection 2							
di8	Selection parameter set 1							
di9	Selection parameter set 2							
di10	OVC+ (3-pnt. stepping)							
di11	OVC- (3-pnt. stepping) w/dW							
di12	Tracking							
Outputs								
OUT1	Y1			-		Y1		
OUT2	-	-	Y2	Y1	-	Y2	-	
OUT3	Xeff							
OUT4	Alarm1			Y2		Alarm1		
OUT5	Alarm2							
do1	Programmer output 1							
do2	Programmer output 2							
do3	Programmer output 3							
do4	Programmer output 4							
do5	Auto/man							
do6	W/Wext							



9499-040-44211

Subject to alterations without notice
Änderungen vorbehalten
Sours réserve de toutes modifications

© PMA Prozeß- und Maschinen-Automation GmbH
P.O.B. 310 229, D-34058 Kassel, Germany
Printed in Germany 9499 040 44211 (10/2013)

A4 auf A5 gefaltet, 2-fach geheftet, SW-Druck Normalpapier weiß 80g/m²