

VARIO AO 1/SF

I/O Extension Module With One Analog Output

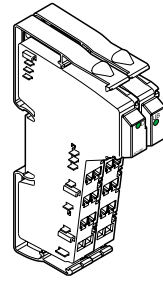

5562A001

User Manual

02/2003



All modules will be delivered including connectors and labeling fields



This data sheet is only valid in association with the documents of the used fieldbus coupler



Only **one** output must be used on the terminal. Use a connector with shield connection when installing the actuator.

Function

The terminal is designed for use within an VARIO station. It is used to output analog voltage or current signals. The signals are available with a resolution of 16 bits.

Features

- One analog signal output to connect either voltage or current signals
- Actuator connection in 2-wire technology with shield connection
- Two current ranges, one voltage range:
0 mA to 20 mA, 4 mA to 20 mA
0 V to 10 V
- Process data update including conversion time of the digital-to-analog converter < 1 ms

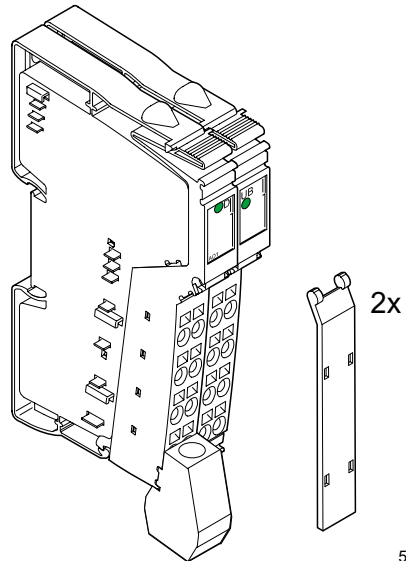

5562AB08

Figure 1 module VARIO AO 1/SF
with connectors to output voltages

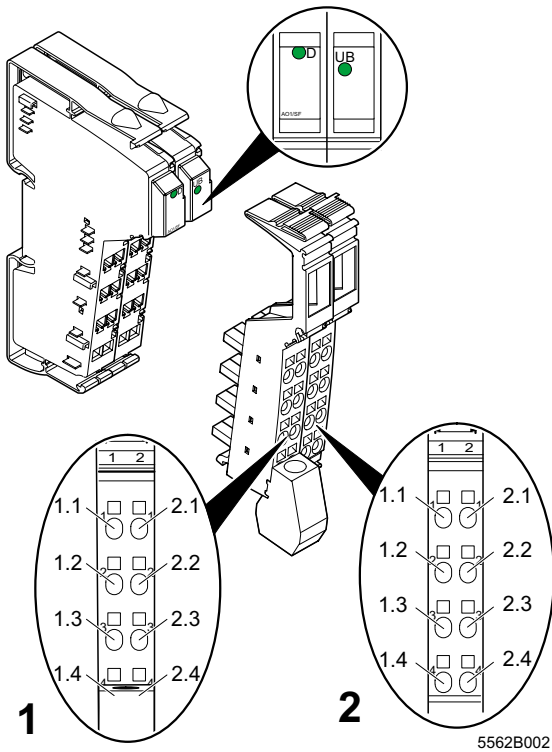

Figure 2 VARIO AO 1/SF with appropriate connectors

Local LED Diagnostic and Status Indicators

Des.	Color	Meaning
D	Green	Bus diagnostics
UB	Green	I/O voltage for analog terminals present (current level)

Terminal Assignment

Conn ector	Terminal Point	Signal	Assignment
1	1.1	U	Voltage output 0 V to 10 V
	2.1	–	Not used
2	1.1	I	Current output 0 mA to 20 mA
	2.1	I	Current output 4 mA to 20 mA
1 and 2	1.2, 2.2	–	Not used
	1.3, 2.3	GND	Ground
	1.4, 2.4	Shield	Shield connection

Installation Instructions

High current flowing through the potential jumpers U_M and U_S leads to a temperature rise of the potential jumpers and the inside of the terminal. Observe the following instructions to keep the current flowing through the potential jumpers of the analog terminals as low as possible:



Create a separate main circuit for each analog terminal.

If this is not possible in your application and if you are using analog terminals in a main circuit together with other terminals, place the analog terminals behind all the other terminals at the end of the main circuit.

Please note the derating curve on page 12.



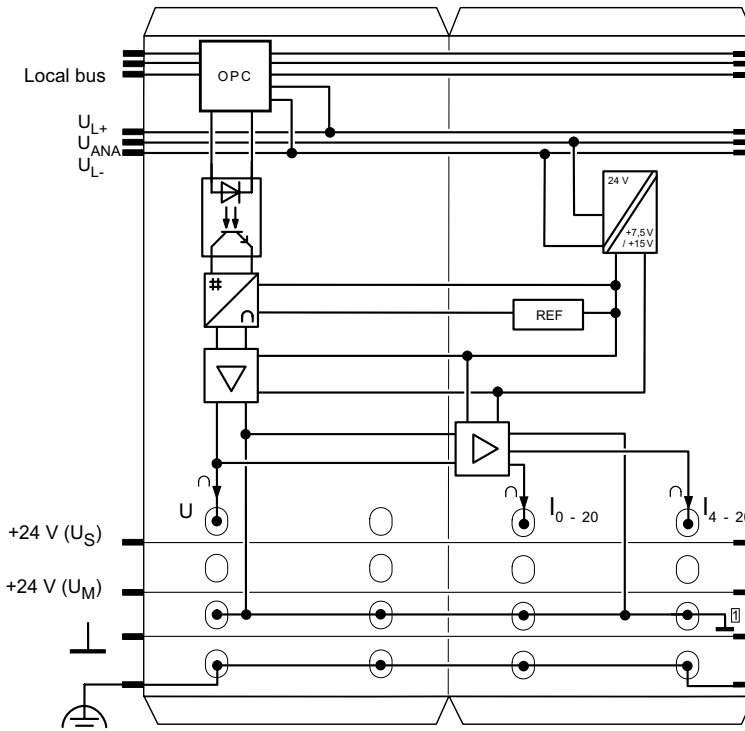





Internal Circuit Diagram



5562C003

Figure 3 Internal wiring of the terminal points

Key:

	Protocol chip		Amplifier
	Optocoupler		Digital-to-analog converter
	DC/DC converter with electrical isolation		Analog output
	Reference voltage		Analog ground, electrically isolated from ground of the potential jumper

Electrical Isolation

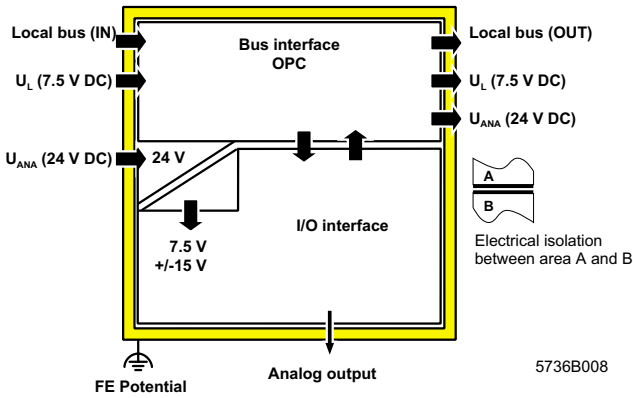

Figure 4 Electrical isolation of the individual function areas

Connection Notes



Always connect the analog actuator using shielded, twisted pair cables.

Connect one end of the shielding to PE. At the module, fold the outer cable sheath back and connect the shield to the terminal via the shield clamp. The clamp connects the shield directly to FE on the terminal side.



When using cables longer than 10 m (32.81 ft.) in environments prone to interference, we recommend connecting the shield on the actuator to the FE potential via an RC element. Typically, the capacitor C should be rated between 1 and 15 nF. The resistor R should be at least 10 MΩ.

Use an I/O connector with shield connection when installing the actuator. On the base side that is not used to connect an actuator, you may use one of the connectors listed in the ordering data. The appearance of the module differs depending on the output used. This is shown in Figure 5 and Figure 6 in the top left corner.

Connection Examples



Use a connector with shield connection when installing the actuator. Figure 5 and Figure 6 show the connection schematically (without shield connector).

Voltage Output

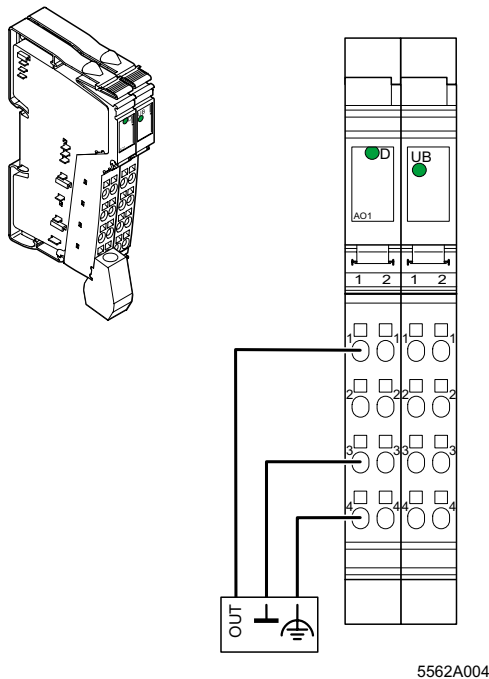

Figure 5 Actuator connected to the voltage output 0 V to 10 V in 2-wire technology with shield connection

Current Output

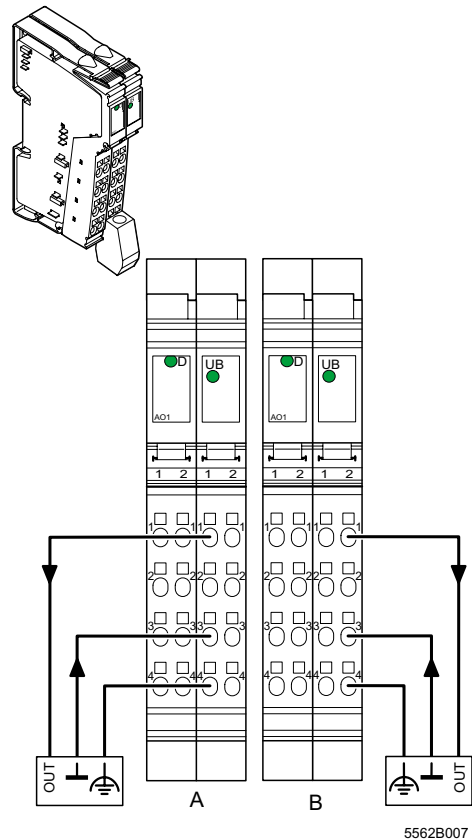

Figure 6 Actuator connected to the current outputs in 2-wire technology with shield connection

- A Signals for actuator at the current output 0 mA to 20 mA
- B Signals for actuator at the current output 4 mA to 20 mA

Programming Data

General

ID code	7D _{hex} (125 _{dec})
Length code	01 _{hex}
Input address area	0 bytes
Output address area	2 bytes
Parameter channel (PCP)	0 bytes
Register length (bus)	2 bytes

Different Fieldbus Systems



For the programming data of other bus systems, please refer to the appropriate electronic device data sheet (GSD, EDS).

Process Data Words

Assignment of the Terminal Points to the Process Data Output Word

"Word.bit" view	Word	Word x														
	Bit	15	14	13	12	11	10	9	8	7	6	5	4	3	2	1
"Byte.bit" view	Byte	Byte 0							Byte 1							
	Bit	7	6	5	4	3	2	1	0	7	6	5	4	3	2	1
Terminal points slot 1	Signal	Terminal point 1.1: Voltage output														
	Signal reference	Terminal point 1.3, 2.3														
	Shielding (FE)	Terminal point 1.4, 2.4														
Terminal points slot 2	Signal	Terminal point 1.1: Current output 0 to 20 mA Terminal point 2.1: Current output 4 to 20 mA														
	Signal reference	Terminal point 1.3, 2.3														
	Shielding (FE)	Terminal point 1.4, 2.4														

OUT Process Data Output Word

The process data output word specifies the output value in each cycle.

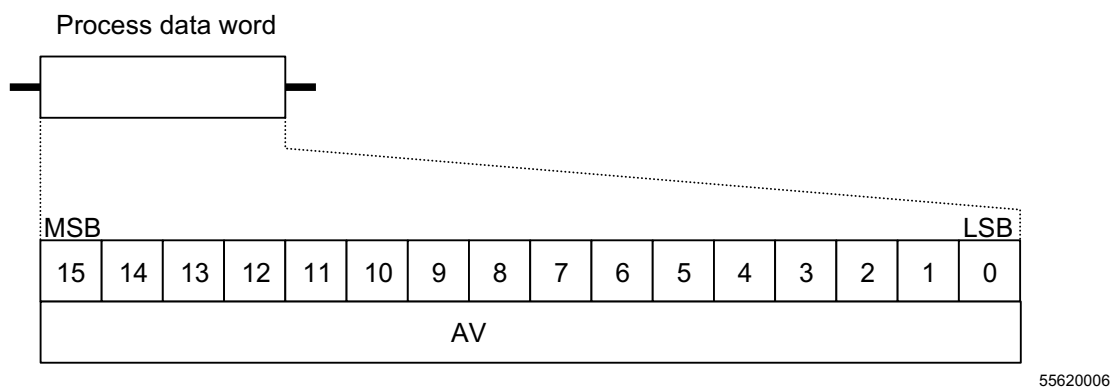

Figure 7 Process data output word

AV Analog value

MSB Most significant bit

LSB Least significant bit

All output values are displayed with 16-bit resolution.

For significant values in the process data word, refer to the following tables.

Output Behavior of the Voltage or Current Output



Take the behavior of the output in the event of an error into account when planning your system.

Switching Operation/State of the Supply Voltage	Marginal Condition	OUT Process Data Word (hex)	Behavior/Status of the Analog Output		
			0 V to 10 V	0 mA to 20 mA	4 mA to 20 mA
U_{ANA} from 0 V to 24 V	$U_L = 0$ V	xxxx	0 V	0 mA	4 mA
U_{ANA} from 24 V to 0 V	$U_L = 7.5$ V	xxxx	0 V	0 mA	0 mA
Bus in STOP state	$U_{ANA} = 0$ V	xxxx	0 V	0 mA	0 mA
Bus in STOP state	$U_{ANA} = 24$ V	xxxx	Maintains last value		

U_{ANA} Analog supply voltage of the terminal

U_L Supply voltage of the module electronics (communications power)

xxxx Any value in the range from 0000_{hex} to FFFF_{hex}.



The behavior and status of the output depends on the output used.

Response of the Control System or Computer to a Hardware Signal for Different Control or Computer Systems

Signal	Control or Computer System	Status After the Switching Operation		
		OUT Process Data Output Word	Analog Output	
			U _{out}	I _{out}
NORM*	AEG Schneider Automation	0000	0 V	0 mA/4 mA
BASP	Siemens S5	0000	0 V	0 mA/4 mA
CLAB	Bosch	0000	0 V	0 mA/4 mA
SYSFAIL	VME	0000	0 V	0 mA/4 mA
SYSFAIL	PC	0000	0 V	0 mA/4 mA
CLEAR OUT	Moeller IPC	0000	0 V	0 mA/4 mA

* On controller boards for AEG Schneider Automation control systems it is possible to set the NORM signal so that the OUT process data output word and the analog output maintain the last value.





The status of the current output depends on the range selected.

Response of the Voltage and Current Outputs to a Control Command of the Controller Board

Command	Status After the Switching Operation		
	OUT Process Data Output Word	Analog Output	
		U _{out}	I _{out}
STOP	Maintain last value	Maintain last value	Maintain last value
ALARM STOP (reset)	Maintain last value	Maintain last value	Maintain last value

Technical Data

General	
Housing dimensions (width x height x depth)	24.4 mm x 120 mm x 71.5 mm (0.961 x 4.724 x 2.815 in.)
Weight	90 g (without connectors), 100 g (including connectors)
Operating mode	Process data mode with 1 word
Type of actuator connection	2-wire technology
Permissible temperature (operation)	-25°C to +55°C (-13°F to +131°F)
Permissible temperature (storage/transport)	-25°C to +85°C (-13°F to +185°F)
Permissible humidity (operation)	75% on average, 85% occasionally
	In the range from -25°C to +55°C (-13°F to +131°F) appropriate measures against increased humidity (> 85%) must be taken.
Permissible humidity (storage/transport)	75% on average, 85% occasionally
	For a short period, slight condensation may appear on the outside of the housing if, for example, the terminal is brought into a closed room from a vehicle.
Permissible air pressure (operation)	80 kPa to 106 kPa (up to 2000 m [6562 ft.] above sea level)
Permissible air pressure (storage/transport)	70 kPa to 106 kPa (up to 3000 m [9843 ft.] above sea level)
Degree of protection	IP 20 according to IEC 60529
Class of protection	Class 3 according to VDE 0106, IEC 60536

Deviations From Common Technical Data That Is Indicated in the User Manual

Mechanical Requirements

Shock test according to EN 60068-2-27, IEC 60068-2-27	15g load for 11 ms, half sinusoidal wave, three shocks in each space direction and orientation 25g load for 6 ms, half sinusoidal wave, three shocks in each space direction and orientation
--	---

Interface	
Local bus	Through data routing

Power Consumption	
Communications power U_L	7.5 V
Current consumption from U_L	30 mA, typical; 40 mA, maximum
I/O supply voltage U_{ANA}	24 V DC
Current consumption at U_{ANA}	50 mA, typical; 65 mA, maximum
Total power consumption	1.425 W (typical)

Supply of the Module Electronics and I/O Through Bus Terminal/Power Terminal	
Connection method	Potential routing

Derating: Permissible Ambient Temperature Depending on the Current of the Voltage Jumpers U_M and U_S (Total Current)

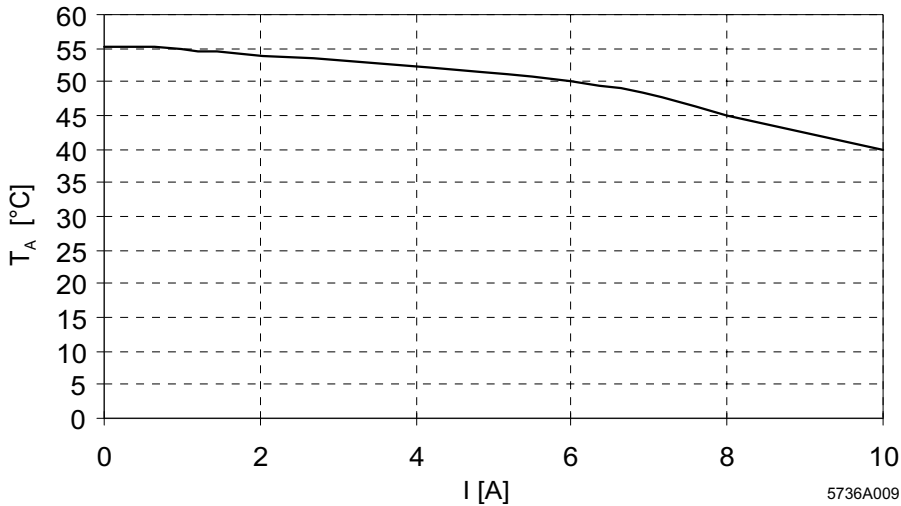

T_A [°C] Ambient temperature in °C
 I [A] Current flowing through potential jumpers U_M and U_S (A)

Analog Output			
Number	1; configured depending on the terminal point used		
Signals/resolution in the process data word (quantization)			
Voltage	0 to 10 V	0 to 9.99985 V	0.153 mV/LSB
Current	0 to 20 mA	0 to 19.9997 mA	0.305 μ A/LSB
	4 to 20 mA	4 to 19.99976 mA	0.244 μ A/LSB
Measured value representation	16-bit straight binary		
Basic error limit in the current range	$\pm 0.05\%$, typical		
Output load			
Voltage output	2 k Ω , minimum		
Current output	500 Ω , maximum		
Process data update including conversion time of the digital-to-analog converter	1 bus cycle (dependent on the bus configuration); < 1 ms		
Slew rate (> 99% of final value)	< 10 μ s		

Tolerance Behavior and Temperature Response of the Voltage Output (The error indications refer to the output range final value of 10 V.)		
	Typical	Maximum
Error at 23°C (73.4°F)		
Total offset voltage	$\pm 0.03\%$	$\pm 0.05\%$
Gain error	$\pm 0.10\%$	$\pm 0.15\%$
Differential non-linearity	$\pm 0.0012\%$	$\pm 0.003\%$
Total error at 23°C (73.4°F)	$\pm 0.15\%$	$\pm 0.25\%$
Temperature response at -25°C to +55°C (-13°F to +131°F)		
Offset voltage drift T_{KVO}	± 10 ppm/K	± 65 ppm/K
Gain drift T_{KG}	± 30 ppm/K	± 35 ppm/K
Total voltage drift $T_{Ktot} = T_{KVO} + T_{KG}$	± 40 ppm/K	± 100 ppm/K
Total error of the voltage outputs (-25°C to +55°C [-13°F to +131°F]) Offset error + gain error + linearity error + drift error	$\pm 0.30\%$	$\pm 0.60\%$

Tolerance Behavior and Temperature Response of the Current Output (0 mA to +20 mA) (The error indications refer to the output range final value of 20 mA.)		
	Typical	Maximum
Offset error at 23°C (73.4°F)		
Offset current I_{oc}	±0.05%	±0.15%
Gain error	±0.09%	±0.25%
Differential non-linearity	±0.0012%	±0.003%
Total error at 23°C (73.4°F)	±0.15%	±0.25%
Temperature response at -25°C to +55°C (-13°F to +131°F)		
Offset current drift T_{KIO}	±25 ppm/K	±65 ppm/K
Gain drift T_{KG}	±10 ppm/K	±35 ppm/K
Total current drift $T_{Ktot} = T_{KIO} + T_{KG}$	±35 ppm/K	±100 ppm/K

Tolerance Behavior and Temperature Response of the Current Output (4 mA to +20 mA) (The error indications refer to the output range final value of 20 mA.)		
	Typical	Maximum
Offset error at 23°C (73.4°F)		
Offset current I_{oc}	±0.15%	±0.45%
Gain error	±0.25%	±0.45%
Differential non-linearity	±0.003%	±0.005%
Total error at 23°C (73.4°F)	±0.25%	±0.46%
Temperature response at -25°C to +55°C (-13°F to +131°F)		
Offset current drift T_{KIO}	±28 ppm/K	±70 ppm/K
Gain drift T_{KG}	±15 ppm/K	±40 ppm/K
Total current drift $T_{Ktot} = T_{KIO} + T_{KG}$	±43 ppm/K	±110 ppm/K

Additional Tolerances Influenced by Electromagnetic Fields		
Type of Electromagnetic Interference	Criterion	Typical Relative Deviation of the Measuring Range Final Value
Electromagnetic fields Field strength 10 V/m according to EN 61000-4-3/IEC 61000-4-3	A	< 1%
Fast transients (bursts) Supply 2 kV, output 1 kV according to EN 61000-4-4/IEC 61000-4-4	B	< 1%
Conducted interference Class 3 (test voltage 10 V) according to EN 61000-4-6/IEC 61000-4-6	A	< 6%

Safety Devices	
None	

Electrical Isolation/Isolation of the Voltage Areas	
	The electrical isolation of the logic level from the I/O area is ensured by the DC/DC converter.

Common Potentials	
24 V I/O voltage, 24 V segment voltage, and GND have the same potential. FE is a separate potential area.	
Separate Potentials in the System Consisting of Bus Terminal/Power Terminal and I/O Terminal	
- Test Distance	- Test Voltage
7.5 V supply (bus logic)/24 V supply U_{ANA} /I/O	500 V AC, 50 Hz, 1 min.
7.5 V supply (bus logic)/24 V supply U_{ANA} /functional earth ground	500 V AC, 50 Hz, 1 min.
24 V supply (I/O)/functional earth ground	500 V AC, 50 Hz, 1 min.

Error Messages to the Higher-Level Control or Computer System	
Failure or insufficient communications power U_L	Yes, I/O error message sent to the bus coupler

Ordering Data

Description	Order Designation	Order No.
Module with one analog output to output either voltage or current signals; including connectors and labeling fields	VARIO AO 1/SF	KSVC-103-00211

PMA Prozess- und Maschinen-Automation GmbH
Miramstrasse 87
34123 Kassel
Germany



+49 - (0)561 505 - 1307



+49 - (0)561 505 - 1710



www.pma-online.de