

MaxVU Full Manual



Certain features are applicable only to instruments with the latest firmware.

This manual supplements the Concise Product manual supplied with each instrument at the time of shipment. Information in this installation, wiring and operation manual is subject to change without notice.

Copyright © West Control Solutions, all rights reserved. No part of this publication may be reproduced, transmitted, transcribed or stored in a retrieval system, or translated into any language in any form by any means without the written permission of West Control Solutions.

Copies of this manual are available in electronic format on the West Control Solutions web site (www.west-cs.com).



WARNING: THE INTERNATIONAL HAZARD SYMBOL IS INSCRIBED ADJACENT TO THE REAR CONNECTION TERMINALS.



IT IS IMPORTANT TO READ THIS MANUAL BEFORE INSTALLING OR COMMISSIONING THE UNIT.

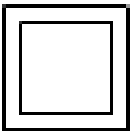

WARNING: THIS SYMBOL MEANS THE EQUIPMENT IS PROTECTED THROUGHOUT BY DOUBLE INSULATION.



WARNING: PRODUCTS COVERED BY THIS MANUAL ARE SUITABLE FOR INDOOR USE, INSTALLATION CATEGORY II, POLLUTION CATEGORY 2 ENVIRONMENTS.



Note: *It is strongly recommended that applications incorporate a high or low limit protective device, which will shut down the equipment at a pre-set process condition in order to prevent possible damage to property or products.*



Warranty and Returns Statement

This information is to be used with the published Terms and Conditions.

These products are sold by West Control Solutions under the warranties set forth in the following paragraphs. Such warranties are extended only with respect to a purchase of these products, as new merchandise, directly from West Control Solutions or from a West Control Solutions distributor, representative or reseller and are extended only to the first buyer thereof who purchases them other than for the purpose of resale.

Warranty

These products are warranted to be free from functional defects in material and workmanship for three years from the time the products leave West Control Solutions factory and to conform at that time to the specifications set forth in the relevant West Control Solutions instruction manuals sheet or sheets.

THERE ARE NO EXPRESSED OR IMPLIED WARRANTIES, WHICH EXTEND BEYOND THE WARRANTIES HEREIN AND ABOVE SET FORTH. NO WARRANTY IS MADE OF MERCHANTABILITY OR FITNESS FOR A PARTICULAR PURPOSE WITH RESPECT TO THE PRODUCTS.

Limitations

West Control Solutions shall not be liable for any incidental damages, consequential damages, special damages, or any other damages, costs or expenses excepting only the cost or expense of repair or replacement as described above. Products must be installed and maintained in accordance with West Control Solutions instructions. There is no warranty against damage to the product resulting from corrosion. Users are responsible for the suitability of the products to their application.

For a valid warranty claim, the product must be returned carriage paid to the supplier within the warranty period. The product must be properly packaged to avoid damage from electrostatic discharge (ESD) or other forms of harm during transit.



Contents

Warranty and Returns Statement iii

1 Installation 7

1.1 Unpacking7

1.2 Installation7

1.3 Panel Cut-outs7

1.4 Cleaning8

2 Electrical Installation 9

2.1 Installation Considerations9

2.2 AC Power Wiring - Neutral (for 100 to 240V AC versions)9

2.3 Wire Isolation9

2.4 Use of Shielded Cable10

2.5 Noise Suppression at Source10

2.6 Sensor Placement (Thermocouple or RTD)11

2.7 Rear Panel Wiring12

3 Powering Up 13

3.1 Powering Up Procedure13

3.2 Auto-Tune13

3.3 Front Panel14

3.4 General Navigation14

3.5 Device Configuration14

3.6 Mode (or Menu) Structure15

3.7 Returning to User Mode15

3.8 Mode Access and Lock Codes15

3.9 Use of the Controller for Non-Temperature Applications16

3.10 Warnings and Error Messages16

4 Setup Mode (First Power-Up) 18

5 User Mode 20

5.1 Basic Setpoint Control - Disabled20

5.2 Basic Setpoint Control - Enabled21

5.3 Comparing Basic Setpoint Control Enabled with Disabled21

5.4 Indicator Enabled/Disabled (*Indc*)22

6 Advanced Configuration Mode (*Adv*) 23

6.1 User sub-menu (*USER*)24

6.2 Input sub-menu (*InPt*)24

6.3 Calibration sub-menu (*CAL*)25

6.4 Output sub-menu (*OUTP*)26

6.5 Control sub-menu (*Cont*)27

6.6 Setpoint sub-menu (*SPt*)29

Standard Controller Setpoint 29



- 6.7 Alarm sub-menu (*ALRM*) 30
- 6.8 Comms sub-menu (*COM*) 30
- 6.9 Display sub-menu (*DISP*) 31
- 6.10 Operator sub-menu (*OPtr*) 31
- 6.11 Info sub-menu (*InfO*) 31
- 7 “Extrusion” Version Controller sub-menus 32**
- 7.1 Output sub-menu (*OUTP*) “Extrusion” version 32
- 7.2 Control sub-menu (*CONt*) “Extrusion” version 32
- 7.3 Setpoint Sub-menu (*SP*) “Extrusion” version 34
- 7.4 Alarm sub-menu (*ALr 7*) “Extrusion” version 34
- 7.5 Soft Start feature (“Extrusion” version) 35
- 7.6 Non-linear Cooling feature (“Extrusion” version) 35
- 8 Manually Tuning Controllers 36**
- 8.1 Single Control Tuning (PID with Heat Output only) 36
- 8.2 Manually Tuning PID 37
- 8.3 Manually Fine Tuning the PID Settings 38
- 9 Calibration Mode 39**
- 9.1 Single point calibration (PV Offset) 39
- 9.2 Two Point Calibration 40
- 10 Serial Communications 41**
- 10.1 Supported Protocol 41
- 10.2 RS485 Configuration 41
- 10.3 RS485 Device Addressing 41
- 10.4 Link Layer 42
- 10.5 Supported Modbus Functions 43
- 10.6 Function Descriptions 43
- 11 Modbus Addresses 45**
- 11.1 Input parameters 45
- 11.2 User Calibration 47
- 11.3 Auto Calibration 47
- 11.4 Output Option 1 parameters 48
- 11.5 Output Option 2 parameters 48
- 11.6 Output Option 3 parameters 49
- 11.7 Control 50
- 11.8 Setpoint 53
- 11.9 Alarm parameters 53
- 11.10 Display parameters 55
- 11.11 Communications 55
- 11.12 Manufacturing Information 56



12	Device Configurator PC Software	57
12.1	Features	57
12.2	Brief Guide to Starting the Software	58
13	Thermocouple Identification and Ranges	59
14	Specifications.....	60
15	Glossary.....	62
16	Product Code.....	78
17	West Control Solutions.....	79

1 Installation

1.1 Unpacking

Carefully remove the product from its packing. Please retain the packing for future use. The instrument is supplied with a panel gasket and push-fit fixing strap. A single sheet concise manual is also supplied in one or more languages. Examine the delivered items for damage or defects. If any are found, contact your supplier immediately.

1.2 Installation



Installation should be only performed by technically competent personnel. It is the responsibility of the installing engineer to ensure that the configuration is safe. Local Regulations regarding electrical installation & safety must be observed (e.g. US National Electrical Code (NEC) or Canadian Electrical Code).

1.3 Panel Cut-outs

The mounting panel must be rigid and may be up to 6.0mm (0.25 inches) thick.

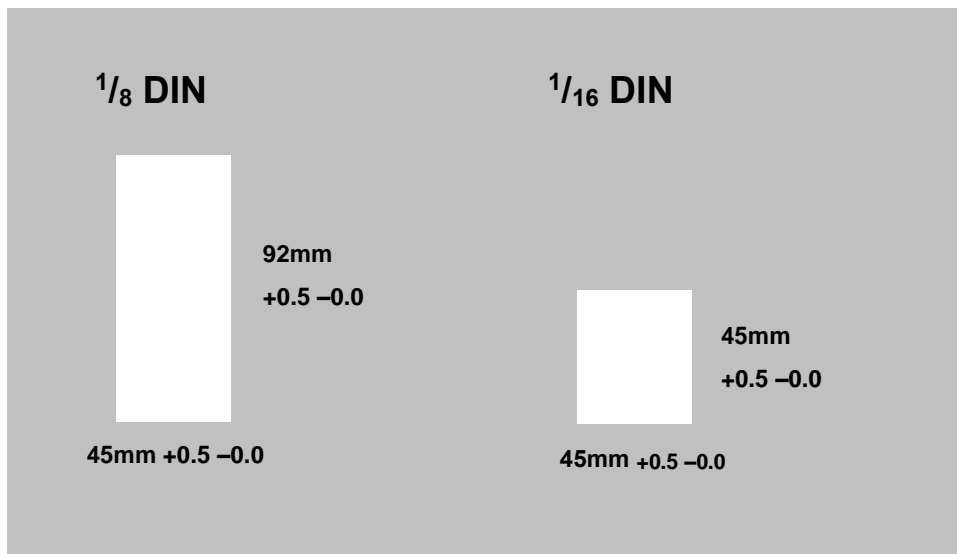

For n multiple instruments mounted side-by-side, cut-out width is 48n-4mm.



Ensure there is adequate air flow inside the panel to prevent overheating.

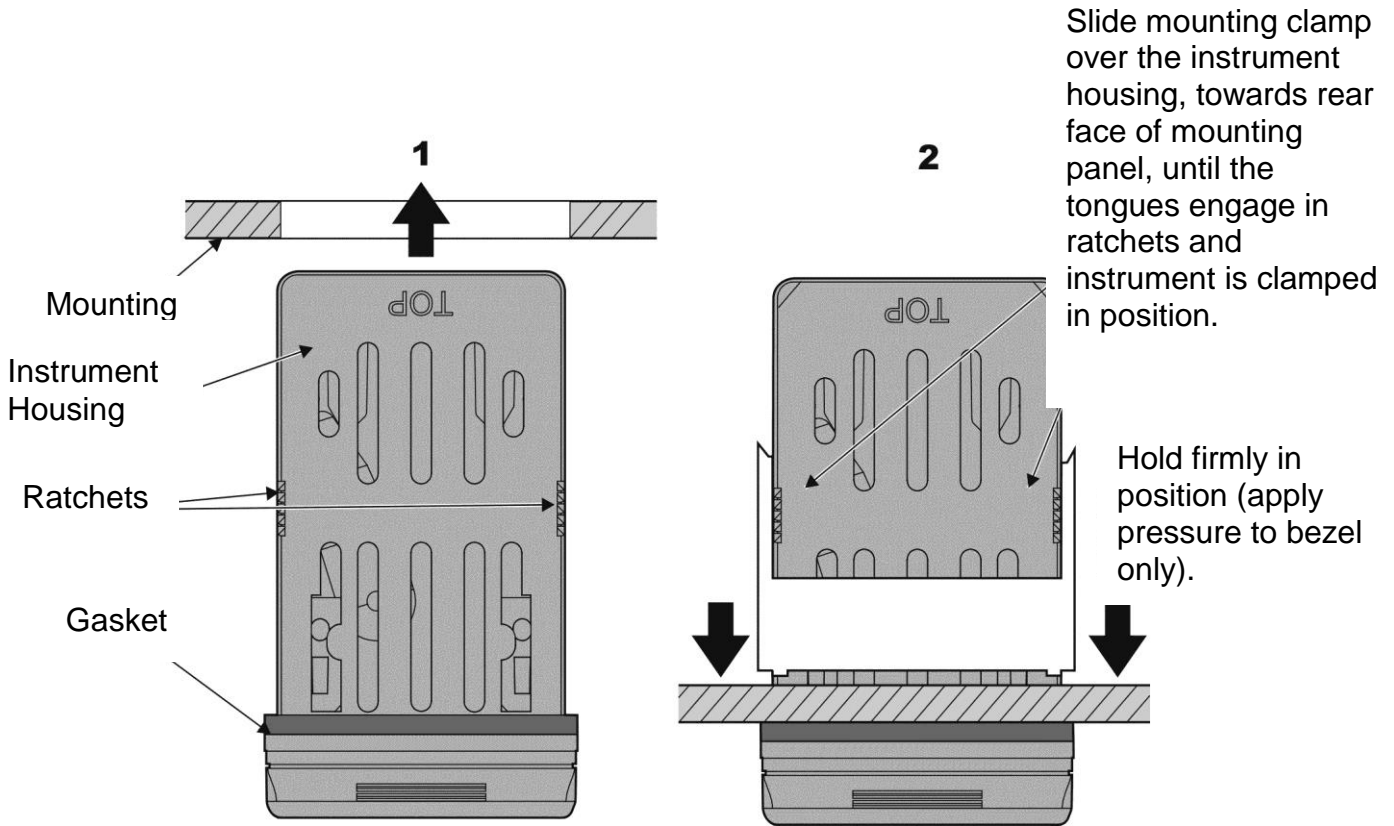

For an effective IP65 seal against dust and moisture, ensure gasket is firmly but evenly compressed against the panel, with the 4 tongues located into the same ratchet slot.

1.4 Cleaning

Clean the front panel by dampening a cloth, with warm soapy water only, and dry immediately.

2 Electrical Installation



The installation should be only performed by technically competent personnel.

It is the responsibility of the installing engineer to ensure that the configuration is safe.

Local Regulations regarding electrical installation & safety must be observed (e.g. US National Electrical Code (NEC) or Canadian Electrical Code).

2.1 Installation Considerations

Ignition transformers, arc welders, motor drives, mechanical contact relays and solenoids are examples of devices that generate electrical noise in typical industrial environments. The following guidelines MUST be followed to minimise their effects.

If the instrument is being installed in existing equipment, the wiring in the area should be checked to ensure that good wiring practices have been followed.

Noise-generating devices such as those listed should be mounted in a separate enclosure. If this is not possible, separate them from the instrument, by the largest distance possible.

If possible, eliminate mechanical contact relays and replace with solid-state relays. If a mechanical relay cannot be replaced, a solid-state relay can be used to isolate the instrument.

A separate isolation transformer to feed only the instrumentation should be considered. The transformer can isolate the instrument from noise found on the AC power input.

2.2 AC Power Wiring - Neutral (for 100 to 240V AC versions)

It is good practice to ensure that the AC neutral is at or near ground (earth) potential. A proper neutral will help ensure maximum performance from the instrument.

2.3 Wire Isolation

Four voltage levels of input and output wiring may be used with the unit:

Analogue input (for example thermocouple, RTD, VDC, mVDC or mADC)
Relays & Triac outputs
SSR Driver outputs
AC power



The only wires that should run together are those of the same category.

If any wires need to run parallel with any other lines, maintain a minimum space of 150mm between them.

If wires MUST cross each other, ensure they cross at 90 degrees, to minimise interference.

2.4 Use of Shielded Cable

All analogue signals must use shielded cable. This will help eliminate electrical noise induction on the wires. Connection lead length must be kept as short as possible keeping the wires protected by the shielding. The shield should be grounded at one end only. The preferred grounding location is at the sensor, transmitter or transducer.

2.5 Noise Suppression at Source

Usually when good wiring practices are followed no further noise protection is necessary. Sometimes in severe environments the amount of electrical noise is so great that it must be suppressed at source. Many manufacturers of relays, contactors, etc. will supply 'surge suppressors' which mount on the noise source. For those devices that do not have surge suppressors supplied, Resistance-Capacitance (RC) networks and/or Metal Oxide Varistors (MOV) may be added.

Inductive coils: - MOVs are recommended for transient suppression in inductive coils, connected in parallel and as close as possible to the coil. Additional protection may be provided by adding an RC network across the MOV.

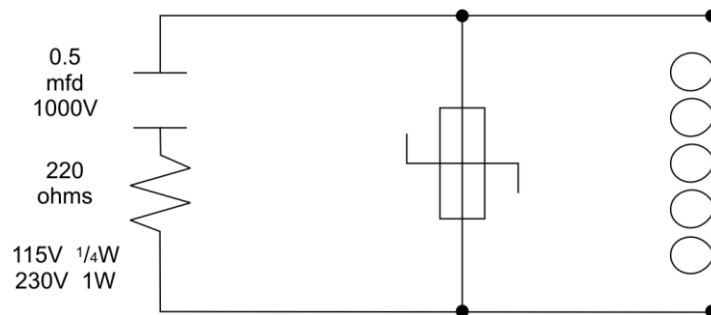

Contacts: - Arcing may occur across contacts when they open and close. This results in electrical noise as well as damage to the contacts. Connecting a properly sized RC network can eliminate this arcing.

For circuits up to 3 amps, a combination of a 47 ohm resistor and 0.1 microfarad capacitor (1000 volts) is recommended. For circuits from 3 to 5 amps, connect two of these in parallel.

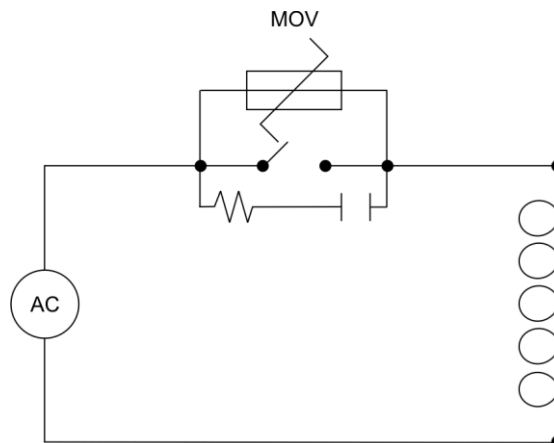

2.6 Sensor Placement (Thermocouple or RTD)

If the temperature probe is to be subjected to corrosive or abrasive conditions, it must be protected by an appropriate thermo-well. The probe must be positioned to reflect the true process temperature:

In a liquid media - the most agitated area

In air - the best circulated area



The placement of probes into pipe work some distance from the heating vessel leads to transport delay, which results in poor control.

For a two wire RTD a wire link should be used in place of the third wire. Two wire RTDs must only be used with lead lengths less than 3 metres. Use of three wire RTDs is strongly recommended.

2.7 Rear Panel Wiring

The rear terminal connections for 1/16 DIN & 1/8 DIN instruments are compatible using A, B & C 1-6.

In general, all wiring connections are made to the instrument after it is installed. Copper wires must be used for all connections (except thermocouple signal wires).



TO AVOID ELECTRICAL SHOCK, AC POWER WIRING MUST NOT BE CONNECTED TO THE SOURCE DISTRIBUTION PANEL UNTIL ALL WIRING PROCEDURES ARE COMPLETED.



CHECK THE INFORMATION LABEL ON THE CASE TO DETERMINE THE CORRECT VOLTAGE BEFORE CONNECTING TO A LIVE SUPPLY.

The diagram shows all possible option combinations. Please check the product configuration before wiring.

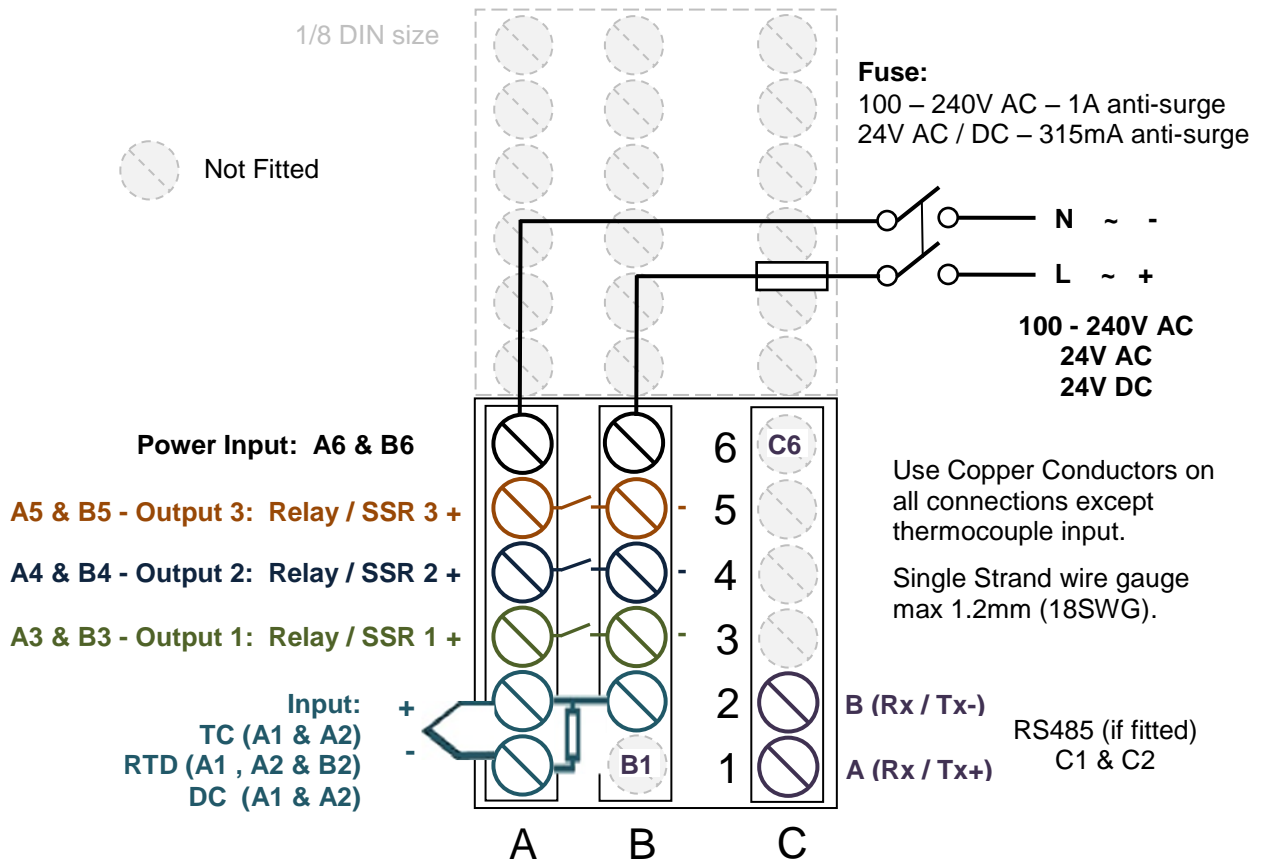

Dedicated Configuration Socket (on bottom of the instrument)

Warning: NEVER DIRECTLY CONNECT THIS SOCKET TO A USB PORT.



A configuration socket to USB adaptor can be obtained from your supplier.

3 Powering Up



**ENSURE SAFE WIRING PRACTICES HAVE BEEN FOLLOWED.
WHEN POWERING UP FOR THE FIRST TIME, DISCONNECT THE OUTPUT
CONNECTIONS.**

Carefully check the supply voltage and connections before applying power.

The instrument must be powered from a supply according to the wiring label on the side of the unit.

100 to 240V ac or 24 / 48V ac/dc depending upon the model purchased.

3.1 Powering Up Procedure

At power-up, a self-test procedure is run, during which all LED segments are lit.

When powering up for the first time the instrument starts up in the Setup Mode and the parameter **TYPE** is displayed on the bottom LED display.



You must complete the Setup by cycling through all the parameters and then exiting the Setup Mode, before using the device for the first time. Otherwise the device will go into the Setup Mode on subsequent power ups.

Please read next sections to understand navigation and use the Setup Mode (First Power-Up) to configure the device.

On subsequent start-up, the instrument will enter the User Mode after self-test.

Any future access to the Setup or Advanced Configuration Modes is lock code protected.

3.2 Auto-Tune

The controller can be auto-tuned from the Setup Mode.

PrE	Pre-tune
ALSP	Auto-tune at setpoint



Auto-tuning will not engage if:

- Controller is set to On/Off control (**H_Pb = On.Off**)
- Setpoint is ramping
- PV is within 5% of the input range (scale range) from Setpoint.

3.3 Front Panel

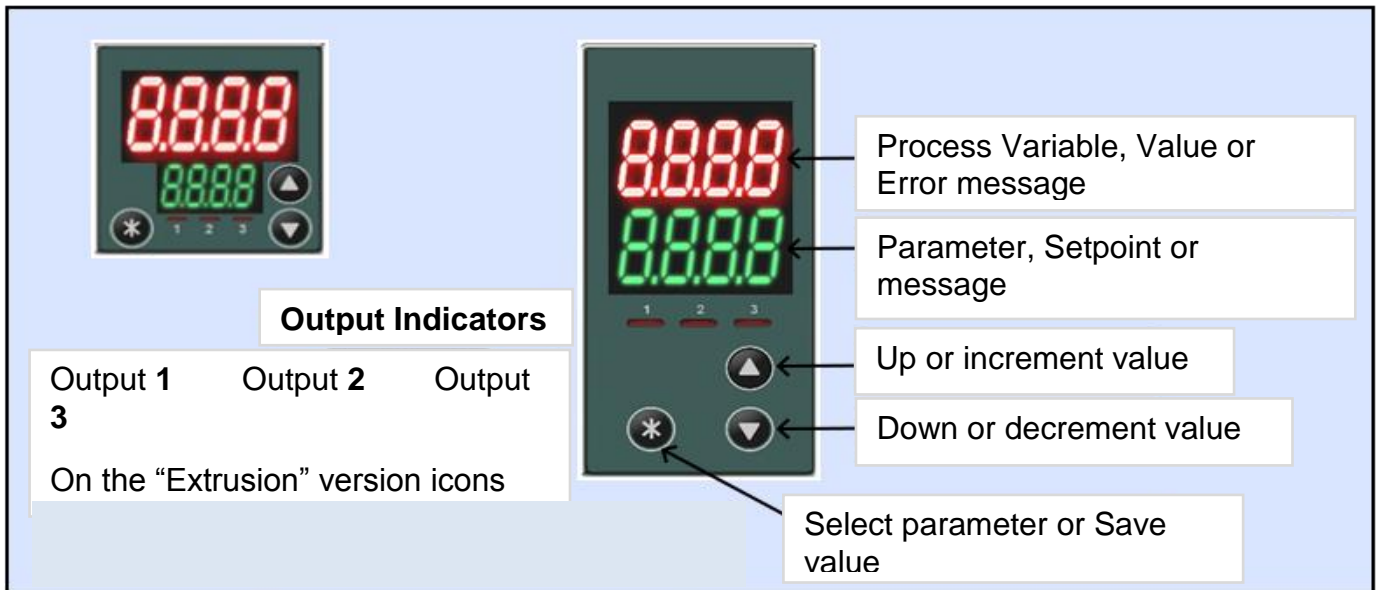

3.4 General Navigation

- Press ▲ or ▼ to navigate between parameters or modes
- To select and edit a parameter, or to enter a mode, press *

The parameter name in the lower display now flashes ready for editing

- Press ▲ or ▼ to change the parameter value in the upper display
- Press * within 60 seconds to save the change, otherwise the change is rejected

The LED displays describe the parameters and values you are editing.

3.5 Device Configuration

The device can be configured from the front panel or via the configuration software. Connection to a PC can be either via the dedicated configuration socket (requires cable CONV-BA-00-00-00-MV) or via RS-485.



Warning: Never connect the instrument's configuration socket directly to a USB port as it could damage the controller or your PC.

3.6 Mode (or Menu) Structure

There are 3 main modes (or menus) on the device
 – User, Setup and Advanced Configuration Mode.

- I. **User Mode** - the live screen used for normal operation. The process variable can always be seen, on the top screen, in this mode.
- II. **Setup Mode** – allows quick access to the most important parameters.
- III. **Advanced Configuration Mode** - access all parameters via sub-menus.

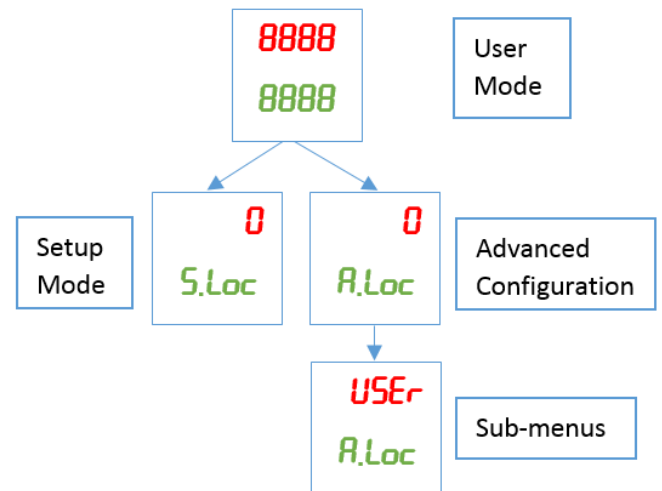

Hold * & press ▲ for Set-up menu.
 Hold * & press ▼ for Advanced Configuration Mode.



The device detects what options are purchased and intelligently hides parameters that are not relevant to your current configuration.

Some parameters on the “Plastics Extrusion” Controller version differ from the standard controller. Please see section “Extrusion” Version Controller sub-menus later.

3.7 Returning to User Mode

Hold * and press ▲.

From a sub-menu you will need to do this twice - once to return to Advanced Configuration Mode (Adu) then again to exit Adu.

You will return to the normal User Mode with the PV displayed.

3.8 Mode Access and Lock Codes

Separate lock codes can be set for the Setup Mode (First Power-Up) and for the Advanced Configuration Mode (Adu).

S.Loc Setup Mode lock code – default 10.
A.Loc Advanced Configuration Mode lock code – default 20.



Tip: Hold ▲ button whilst powering up for a read-only view of lock codes.

3.9 Use of the Controller for Non-Temperature Applications

In most applications, this controller will be used for temperature sensing, either via a sensor or a linear dc input, which use heat and cool. However, this controller can be used for other types of processes.

If your process variable is not temperature, then the parameters labelled as “HEAT” refer to reverse acting outputs used to increase the process value and “COOL” to decrease the process value.

As an example you may have a system that reads and controls humidity. The “HEAT” output drives the humidifier and the “COOL” output drives the de-humidifier. Use the “HEAT” parameters to control the humidifier and the “COOL” parameters to control the de-humidifier.

Often the “HEAT” and “COOL” is referred to as “Primary” and “Secondary” on other controllers.

3.10 Warnings and Error Messages

	Lower	Upper	Meaning & Visibility
Alarm Active		-AL-	One or more alarms are active. Alternates with the PV. (Display is optional – see <i>USER</i>)
Outputs Latched		Ltch	One or more outputs are latched on <u>and</u> no alarm is active. Alternates with the PV.
Input Over Range		-HH-	Process variable input >5% over-range, i.e. above maximum
Input Under Range		-LL-	Process variable input >5% under-range, i.e. below minimum
Input Sensor Break	OFF	OPEN	Break detected in process variable input sensor or wiring
Un-calibrated Input	OFF	Err	Selected input range has not been calibrated
Manual Power	P _{xxx}		Manual percentage power (-100% to 100%)
Setpoint Ramping	SP _r		Setpoint ramp is active (alternates with setpoint)
Control Disabled	OFF		Control outputs are off. (<i>Ctrl=OFF</i>). To resolve set (<i>Ctrl=On</i>)
Control Delayed	dLY		Visible if control delayed by Delayed Start Time (<i>d.t i</i>)
Automatic Tuning	tunE		Tuning is active
Automatic Tuning Errors	The tune error code appears if tune attempt fails. Set tune to <i>OFF</i> to clear tuning errors.		
	tEr1		PV is within 5% of scaled range from setpoint (reduce scaled range)
	tEr2		Setpoint is ramping
	tEr3		Control is ON/OFF, not PID (<i>H.Pb</i> or <i>C.Pb = 0</i>)
	tEr4		Control is Manual



	Lower	Upper	Meaning & Visibility
	tEr5		Tune at Setpoint not able to run
	tEr6		Sensor break
	tEr7		Timer running
	tEr8		Control is disabled (Ctrl=OFF)

4 Setup Mode (First Power-Up)

The device will enter the Setup menu on the first power-up. This menu gives easy access to some of the most commonly required settings.

The entry is lock code protected; see Mode Access and Lock Codes.

Lock Code	5 .Loc	10	Enter lock code to enter Setup Mode. Default is 10.
-----------	---------------	-----------	--

Parameter Name	Lower	Upper	Meaning & Visibility
Input Type	TYPE	tc_J	J thermocouple - Default is tc_P
		tc_K	K thermocouple
		P 100	PT100
		tc_B	B thermocouple
		tc_C	C thermocouple
		tc_L	L thermocouple
		tc_N	N thermocouple
		tc_R	R thermocouple
		tc_S	S thermocouple
		tc_T	T thermocouple
		0_20	0 - 20 mA dc **
		4_20	4 - 20mA dc **
		0_50	0 - 50mV dc
		10_50	10 - 50mV dc **
		0_5	0 - 5V dc **
		1_5	1 - 5V dc **
		Input Units	
F			
Process Display Resolution	dEc .P	0000 000.0 00.00 0.000	Number of decimal places. (2 or 3 decimal places not available for temperature input). Default is 0000

** Not available on “Extrusion” version.

Parameter Name	Lower	Upper	Meaning & Visibility
Scaled Range Upper Limit	<i>ScUL</i>		Upper limit of scaled input range. (Only visible in Setup Mode when a dc linear type is selected). Default is input max
Scaled Range Lower Limit	<i>ScLL</i>		Lower limit of scaled input range. (Only visible in Setup Mode when a dc linear type is selected). Default is input min
Output 1 Usage	<i>Out 1</i>	<i>HEAT COOL AL 1 AL 2 AL 12 Loop</i>	Heat, Cool, Alarm 1, Alarm 2, both Alarms, or Loop Alarm. Default is HEAT
Output 2 Usage	<i>Out2</i>		Same options as Output 1. Out2 Default is AL 1
Output 3 Usage	<i>Out3</i>		Out3 Default is AL 2
Alarm 1 Adjust	<i>AL_1</i>		Sets the Alarm 1 value. (Range minimum to range maximum) OFF disables the alarm. (Default alarm type is high alarm)
Alarm 2 Adjust	<i>AL_2</i>		Sets the Alarm 2 value. (Range minimum to range maximum) OFF disables the alarm. (Default alarm type is low alarm)
Setpoint Adjust	<i>SP</i>		Target setpoint. Adjustable between setpoint upper and lower limits Default is 0
Automatic Tuning Start/Stop	<i>tunE</i>	<i>OFF PrE AtSP</i>	OFF use current PID control terms or manually tune. PrE start pre-tune AtSP tune at setpoint Default is OFF



Important Note 1: You will be returned to the Setup mode on every subsequent power up unless you scroll through all of the Setup parameters, and then exit from the Setup mode to save the values.



Important Note 2: The parameter **Ctrl** (discussed later in the manual) is set to **On** and the Setpoint to **0** by default when the first Setup is complete. This means the controller outputs are On but with a setpoint of 0°C.

5 User Mode

The normal, live screen showing the PV (process variable) or temperature is called the User Mode. The behaviour of this screen is controlled by parameters called Basic Setpoint Control (**bASc**) and (**Indc**) found in the Display **d, SP** sub-menu, plus the visibility settings within the Operator sub-menu, **OPtr**.

If the lower display is blank see Indicator Enabled.

PV from sensor 51

PV from sensor 51

Setpoint 180

Manual power P 95

5.1 Basic Setpoint Control - Disabled

The first screen shows either the setpoint or manual power.

bASc = d, SA Basic Setpoint Control *(parameters not available on "Extrusion" version)				when OPtr is
MODE = OFF (Auto)	190	51	Target setpoint adjustable	SHLD
MODE = ON (Man)	P 90	51	Manual power adjustable	SHLD
Alarm Status	ALSt		Active when alarms are active – L2 I I = Alarm 1 active 2 = Alarm 2 active L = Loop Alarm active	SHLD
Latch Status	LAtH		Active when an output is latched – 123 1 = Output 1 2 = Output 2 3 = Output 3	SHLD
Maximum PV	PMA		(Read-only) Displays maximum PV since power up or last reset. (To clear press *).	SHLD
Minimum PV	PMin		(Read-only) Displays maximum PV since power up or last reset. (To clear press *).	SHLD
Control Enabled	CnEt	OFF On	Control output(s) disabled Control output(s) enabled – PID or On/Off control available	SHLD
Manual Control Enabled	MODE	OFF On	Automatic control mode Manual control mode (Pxxx shown on the SP screen)	SHLD
Time On Remaining	OnT I		Active when On timer is on **	SHLD
Delay Time Remaining	dLT I		Active when Delay timer is on **	SHLD

5.2 Basic Setpoint Control - Enabled

If Basic Setpoint Control is enabled either the setpoint or manual power will be adjustable only.

In basic mode PV is always shown on the upper display, with auto or manual power below.

PV from sensor	51	PV from sensor	51
Setpoint	180	Manual power	P 95

	Active Parameter	
$\Gamma\eta\zeta\epsilon = OFF$ (Auto)	Target setpoint adjustable	180
$\Gamma\eta\zeta\epsilon = ON$ (Man)	Manual power adjustable	P 95

Any parameters hidden when Basic Setpoint Control is enabled are accessible via the Advanced Configuration sub-menus. If parameter $Indc = EnAb$ then lower SP display is blank.

5.3 Comparing Basic Setpoint Control Enabled with Disabled

$bASc = EnAb$ Basic Setpoint Control <u>Enabled</u>		
Parameter	User Mode screen	sub-menu $OPtr$ (Show or Hide)
$ALSt$	Not Visible	Visible (when alarms are on) in $USEr$
$LRtH$		Visible in $USEr$
$\Gamma\eta A$		Visible in $USEr$
$\Gamma\eta in$		Visible in $USEr$
$CntL$		Visible in $USEr$
$\Gamma\eta\zeta\epsilon$		Visible in $USEr$
$OnE ,$		Visible in $SPt ,$ (Standard version only)
$dLt ,$		Visible in $SPt ,$ (Standard version only)
$bASc = d , SA$ Basic Setpoint Control <u>Disabled</u>		
Parameter	User Mode screen	sub-menu $OPtr$ (Show or Hide)
$ALSt$	Depends on $OPtr$ setting (when alarms are on)	$SHLJ$ or $H idE$
$LRtH$	Depends on $OPtr$ setting (when alarms are on)	$SHLJ$ or $H idE$
$\Gamma\eta A$	Depends on $OPtr$ setting	$SHLJ$ or $H idE$
$\Gamma\eta in$	Depends on $OPtr$ setting	$SHLJ$ or $H idE$
$CntL$	Depends on $OPtr$ setting	$SHLJ$ or $H idE$
$\Gamma\eta\zeta\epsilon$	Depends on $OPtr$ setting	$SHLJ$ or $H idE$
$OnE ,$	Depends on $OPtr$ setting (when alarms are on)	$SHLJ$ or $H idE$
$dLt ,$	Depends on $OPtr$ setting (when delay timer is on)	$SHLJ$ or $H idE$

5.4 Indicator Enabled/Disabled (*Indc*)

The parameter *Indc* is found in the Display (*d* , *SP*) sub-menu. Enabling this will hide the Setpoint in the lower display as demonstrated below.

Any warnings or error messages may still appear in the Lower Display but otherwise the display is blank. Please note that although the set point is hidden the device still acts as a process controller, not a passive 'indicator'.

If *Indc* = *d* , *SA* for Disabled the Setpoint (SP) is visible.

Process Variable	316
Setpoint	350

If *Indc* = *EnAb* for Enabled then the lower SP display is blank.

Process Variable	317
Setpoint	

6 Advanced Configuration Mode (Adv)

The Advanced Configuration Mode allows access to all the parameters, including those accessible in the Setup Mode.



It may be faster to access some parameters from the Setup Mode. There is a factory default option available in the Display sub-menu.

Entry is lock code protected; see Mode Access and Lock Codes.

Whilst in the Advanced Configuration Mode **Adv** is visible on the lower display.

Lock Code	Adv Loc 20	Enter lock code to enter Advanced Configuration mode. Default = 20.
-----------	---------------------------------	--

The Advanced Configuration Mode contains the sub-menus shown below. Once inside a sub-menu the parameter name and value are displayed.

Value	LC_U
Parameter	TYPE

Sub-Menu Name	Lower	Upper	Meaning & Visibility
User	Adv	USER	Provides access to User parameters including Control Enabled and Manual Control Enabled parameters.
Input		INPT	Set up input sensor and range.
Calibration		CAL	For entering up to 2 input calibration points.
Output		OUTP	Set functions for up to 3 outputs.
Control		CONT	Control settings for PID, or ON/OFF control, and Auto-tune.
Setpoint		SPET	Setpoint and timer settings.
Alarm		ALRT	All alarm settings including sensor break alarm.
Comms		COMM	Modbus address, baud rate and parity - only shown if RS485 option is fitted.
Display		DISP	Lock code set up, and Basic Setpoint Control enable/disable, Indicator enable/disable and Factory Defaults.
Operator		OPTR	Visibility setting for parameters that can be made visible in the User Mode.
Info		INFO	Revision level, Firmware version, Serial number and Manufactured date.

6.1 User sub-menu (USER)

Parameter	Lower	Upper	Meaning & Visibility	Default
Alarm Status	ALSt		Visible when alarms are active – L2 1 1 = Alarm 1 active 2 = Alarm 2 active L = Loop Alarm active	
Latch Status	LAth		Active when an output is latched – 123 1 = Output 1 2 = Output 2 3 = Output 3	
Maximum PV	MA		Maximum and Minimum PV recorded whilst powered up or since last reset. To clear press * then to select YES. Press * to accept.	
Minimum PV	MI			
Control Enable	EnL	OFF On	OFF = Control output(s) disabled On = Control output(s) enabled – PID or On/Off control available	On
Manual Control Enable	MCt	OFF On	Auto or Manual power control. OFF = auto, On = manual	OFF

6.2 Input sub-menu (InPt)

Parameter	Lower	Upper	Meaning & Visibility	Default
Input	TYPE	TC_J	J thermocouple -200 to 1200°C (-328 to 2192°F) -128.8 to 537.7°C (-199.9 to 999.9°F)	TC_P
		TC_K	K thermocouple -240 to 1373°C (-400 to 2503°F) -128.8 to 537.7°C (-199.9 to 999.9°F)	
		P100	PT100 -199 to 800°C (-328 to 1472°F) -128.8 to 537.7°C (-199.9 to 999.9°F)	
		TC_B	B thermocouple 100 to 1824°C (211 to 3315°F)	
		TC_C	C thermocouple 0 to 2320°C (32 to 4208°F)	
		TC_L	L thermocouple 0 to 762°C (32 to 1403°F) 0.0 to 537.7°C (32.0 to 999.9°F)	
		TC_N	N thermocouple 0 to 1399°C (32 to 2551°F)	
		TC_R	R thermocouple 0 to 1795°C (32 to 3198°F)	
		TC_S	S thermocouple 0 to 1762°C (32 to 3204°F)	

Parameter	Lower	Upper	Meaning & Visibility	Default
		T	T thermocouple -240 to 400°C (-400 to 752°F) -128.8 to 400.0°C (-199.9 to 752.0°F)	
		0_20	0 - 20 mA dc **	
		4_20	4 - 20 mA dc **	
		0_50	0 - 50 mV dc	
		10_50	10 - 50 mV dc **	
		0_5	0 - 5 V dc **	
		1_5	1 - 5 V dc **	
		0_10	0 - 10 V dc **	
		2_10	2 - 10 V dc **	
Input Units		C F	Select either °C or °F temperature units.	C
Process Display Resolution	dEc .P	0000 000.0 00.00 0.000	Number of decimal places. (2 or 3 decimal places not available for temperature input types).	0000
Scaled Range Upper Limit	ScUL		Upper limit of scaled input range. Scale input lower limit +100 display units to range maximum	Input Max (Lin=1000)
Scaled Range Lower Limit	ScLL		Lower limit of scaled input range. Range minimum to scale input upper limit -100 display units	Input Min (Lin=0)
Input Filter Time	Filt		OFF or 0.5 to 100.0 seconds in 0.5 increments	2.0
Cold Junction Compensation	CJC	On OFF	Enables the internal thermocouple CJC. When OFF External compensation must be provided for thermocouples.	On

** Not available on "Extrusion" version.

6.3 Calibration sub-menu (CAL)

Parameter	Lower	Meaning & Visibility	Default
Single Point Offset	OFFS	Shifts the input value up or down across the entire range, by the value entered.	0
Low Calibration Point	L.CAL	The value at which the low point error was measured is to be applied.	Lower limit
Low Offset	L.OFF	Enter an equal, but opposite offset value to the observed low point error.	0
High Calibration Point	H.CAL	The value at which the high point error was measured.	Upper limit
High Offset	H.OFF	Enter an equal, but opposite offset value to the observed high point error.	0

Please refer to section Calibration Mode.

6.4 Output sub-menu (OUTP)

Parameter	Lower	Upper	Meaning & Visibility	Default
Output 1 Usage	OUT1	HEAT COOL AL1 AL2 AL12 LoopP	Choose the function for Output 1 from: Heat, Cool, Alarm 1, Alarm 2, Alarm 1 or 2, or Control Loop Alarm (2x integral time)	HEAT
Output 1 Alarm Action	Act1	d ir rEu	Output changes with alarm (d ir) Output changes in opposition to alarm (rEu)	d ir
Output 1 Alarm Latching	LAc1	OFF On	Latching OFF or On. (Once on output must be reset to turn off.)	OFF
LED Indicator 1 Inverting	Ind1	d ir rEu	Output 1 LED indicator changes with alarm (d ir) Output 1 LED indication changes in opposition to alarm (rEu)	d ir
Output 2 Usage	OUT2		Same options as Output 1 Usage	AL1
Output 2 Alarm Action	Act2		Same options as Output 1 Alarm Action	d ir
Output 2 Alarm Latching	LAc2		Same options as Output 1 Alarm Latching	OFF
LED Indicator 2 Inverting	Ind2		Same options as LED Indicator 1 Inverting	d ir
Output 3 Usage	OUT3		Same options as Output 1 Usage	AL2
Output 3 Alarm Action	Act3		Same options as Output 1 Alarm Action	d ir
Output 3 Alarm Latching	LAc3		Same options as Output 1 Alarm Latching	OFF
LED Indicator 3 Inverting	Ind3		Same options as LED Indicator 1 Inverting	d ir

6.5 Control sub-menu (Cont)

Parameter	Lower	Meaning & Visibility	Default
Heat Proportional Band	H_Pb	(Primary if not temperature) 0.0 (ON/OFF) or PID control in display units.	16.1
Cool Proportional Band	C_Pb	(Secondary if not temperature) 1 to 9999 - 0 decimal places 0.1 to 999.9 - 1 decimal place 0.01 to 99.99 - 2 decimal places 0.001 to 9.999 - 3 decimal places	16.1
Automatic Reset	Int	Integral time for PI or PID control. I seconds to 99 minutes 59 seconds and OFF	5.00
Rate (Derivative time)	dEr.t	D term for PD or PID. OFF 0 seconds to 99 minutes 59 seconds	1.15
Overlap / Deadband	O_d	In display units, range -20 to +20% of Heat and Cool Proportional Band	0
ON/OFF differential	dIFF	On/Off switching point. In display units, centred about the setpoint, range: 0.1% to 10.0% of input span	8
Loop Alarm Time	LAt ,	Visible when using On/Off control (i.e. when H_Pb or C_Pb = ON/OFF) Sets the time to wait before the loop alarm becomes active. Default 99 mins 59 secs. (If PID then the Loop Alarm Time is 2x integral time)	99.59
Manual Reset (Bias)	b ,AS	Biasing of Proportional Control output. 0 to 100% (heat only) - 100% to 100% (if heat/cool control)	25
Heat Cycle Time	HcYc	Time proportion cycle time for the outputs 0.1 to 512.0 seconds	32.0
Cool Cycle Time	CcYc		32.0
Heat & Cool Output Inhibit	OPLC	Inhibits the simultaneous activation of both heat and cool outputs.	OFF



Parameter	Lower	Meaning & Visibility		Default
Heat Power Limit	<i>HPL</i>	Heating/Primary % power upper limit 0 to 100 %		100
Cool Power Limit	<i>CPL</i>	Cooling/Secondary % power upper limit 0 to 100 %		100
Power Up Action	<i>PUP</i>	LAST On	LAST = Powers up with control enable in the same state as on power fail On = Always powers up with control enabled	LAST
Automatic Tuning Start/Stop	<i>tunE</i>	OFF PrE AtSP	OFF = use current PID control terms or manually tune. PrE = start pre-tune AtSP = tune at setpoint	OFF

6.6 Setpoint sub-menu (SPt i)

Parameter	Lower	Upper / Meaning & Visibility	Default
Timer Enable	tEnb	EnAb d,SA EnAb = Enables the delay and on timers, functions only at the next power-up / control enable. d,SA = Delay and on timers, are ignored, but <u>setpoint ramping is not disabled</u> .	d,SA
Delayed Start Time	d,t,i	The time from power-up or a control enable request before control begins, from 00.01 to 99.99 (Hours.Minutes) or OFF. Control disabled until time elapsed.	OFF
Setpoint Ramp Rate	rAtE	The rate (in units / hour) from current PV to setpoint following power-up or control enable. From 0.001 to 9999 (Hours.Minutes) or OFF. Setpoint value changes also follow this rate.	OFF
On Time	O,t,i	The time the target setpoint will be maintained once reached, from 00.01 to 99.99 (Minutes .Seconds) or INF. Control remains on indefinitely if set to INF.	INF
Setpoint Upper Limit	SPuL	The maximum allowed setpoint value, from current setpoint to scaled upper limit.	Upper Limit
Setpoint Lower Limit	SPlL	The minimum allowed setpoint value, from current setpoint to scaled lower limit.	Lower Limit

Standard Controller Setpoint

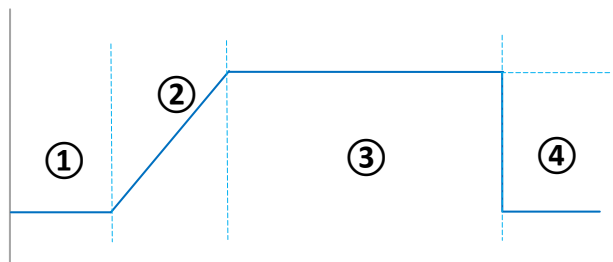

- ① At power on or from control enable the unit will delay enabling control until the Delay Timer expires set by Delayed Start Time - **d,t,i**.
- ② The setpoint then ramps from the current PV to the setpoint at the Setpoint Ramp Rate.
- ③ When a ramp rate is not defined the active setpoint will step directly to the target setpoint. Once the active setpoint reaches the target setpoint, the Control On Timer counts down from the time set by On Time - **O,t,i**.
- ④ When the on timer expires the controller switches off the control output.

If no time is defined for the on timer (**O,t,i**), control continues indefinitely unless manually disabled.

6.7 Alarm sub-menu (ALP)

Parameter	Lower	Upper	Meaning & Visibility	Default
Alarm 1 Type	AL1t	nonE P_h, P_Lo dEv bAnd	Set the function of Alarm 1: None, process High, process Low, Deviation or Band	P_H,
Alarm 1 Value	AL_1		Set the trigger point / value of Alarm 1 Range minimum to range maximum OFF disables the alarm.	1373
Alarm 1 Hysteresis	HYS1		The Alarm 1 switching point hysteresis 0 to full span.	1
Alarm 2 Type	AL2t		Same options as Alarm 1 settings	P_Lo
Alarm 2 Value	AL_2			-240
Alarm 2 Hysteresis	HYS2			1
Alarm Inhibit	inh,	nonE 1 2 1 2	Inhibit alarms if active at power-up and on change in setpoint. None, Alarm 1, Alarm 2, Alarm 1 & 2.	nonE
Alarm Notification	NotE	nonE 1 2 1 2	Enable alarm notification in the User Mode. Alternating indication -AL- shown when alarms are active. None, Alarm 1, Alarm 2, Alarm 1 & 2.	2
Sensor Break Alarm	SbAc	On OFF	On = activates both alarms when a sensor break is detected.	OFF

6.8 Comms sub-menu (CoP)

Parameter	Lower	Meaning & Visibility	Default
Modbus Address	Add	The device network address from 1 to 255	1
Baud Rate	bAud	The communications data rate in kbps from 1.2 (1200) 2.4 (2400) 4.8 (4800) 9.6 (9600) 9.2 (19200) 38.4 (38400).	9.6
Parity	Prty	Parity checking: Odd , EvEn or nonE	nonE

6.9 Display sub-menu (d, SP)

Parameter	Lower	Meaning & Visibility	Default
Setup Lock Code	S.Loc	Set lock code for the Setup mode. OFF, 1 to 9999.	10
Advanced Configuration Lock Code	A.Loc	Set lock code for the Advanced Configuration mode. OFF, 1 to 9999.	20
Basic Setpoint Control Enable/Disable	bASc	Basic Setpoint Control allows user to only change the setpoint or manual power.	d, SA
Indicator Enable/Disable	Indc	When enabled hides the set point in the lower display. Please refer to Indicator Enabled/Disabled.	EnAb
Reset to Defaults	dFLt	Reset all parameters back to their factory defaults. Press * and select YES	

6.10 Operator sub-menu (OPtR)

Parameter	Lower	Upper	Meaning & Visibility	Default
PV Maximum	P7A	H idE SHLd	Hide or show parameter in User Mode. Please refer to the User sub-menu (USER).	H idE
PV Minimum	P7in			H idE
Alarm Status	ALSt		Hide or show in User Mode.	H idE
Latch Status	LAth		Hide or show in User Mode.	SHLd
Control Enabled	CntL		Hide or show in User Mode. Please refer to the User sub-menu (USER).	H idE
Manual Control Enabled	P7Ct			H idE
Time On Remaining	Ont I		Hide or show in User Mode. Please refer to the Setpoint sub-menu (SPt i).	H idE
Delay Time Remaining	dLt I			H idE

6.11 Info sub-menu (Info)

This is a read only view so parameters cannot be altered.

Parameter	Lower	Meaning & Visibility
Product Revision	P rL	The hardware and software revision level
Firmware Type	FtYP	The firmware code type
Firmware Issue	ISS	The firmware version number
Serial Number 1	SEr 1	First four digits of serial number
Serial Number 2	SEr 2	Middle four digits of serial number
Serial Number 3	SEr 3	Last four digits of serial number
Date of Manufacture	dOPp	Manufacturing date code (mmyy)

7 “Extrusion” Version Controller sub-menus

The “Extrusion” version controller has different Output, Control, Setpoint and Alarm sub-menus, compared to the standard model. Sub-menus not listed below are identical to the standard version.

7.1 Output sub-menu (OUTP) “Extrusion” version

Parameter	Lower	Upper	Meaning & Visibility	Default
Output 1 Usage	OUT1	HEAT COOL nLCL AL1 AL2 AL12 Loop	Non-Linear Cooling is added in the “Extrusion” version	HEAT
Output 1 Alarm Action	Act1	dir rEu	Output changes with alarm (dir) Output changes in opposition to alarm (rEu)	dir
Output 1 Alarm Latching	LAc1	OFF On	Latching OFF or On. (Once on output must be reset to turn off.)	OFF
Output 2 Usage	OUT2		Same options as Output 1 Usage	AL1
Output 2 Alarm Action	Act2		Same options as Output 1 Alarm Action	dir
Output 2 Alarm Latching	LAc2		Same options as Output 1 Alarm Latching	OFF
Output 3 Usage	OUT3		Same options as Output 1 Usage	AL2
Output 3 Alarm Latching	LAc3		Same options as Output 1 Alarm Latching	OFF

7.2 Control sub-menu (CONT) “Extrusion” version

Parameter	Lower	Meaning & Visibility	Default
Heat Proportional Band	H_Pb	(Primary if not temperature) 0.0 (ON.OFF) or PID control in display units.	16.1
Cool Proportional Band	C_Pb	(Secondary if not temperature) 1 to 9999 - 0 decimal places 0.1 to 999.9 - 1 decimal place 0.01 to 99.99 - 2 decimal places 0.001 to 9.999 - 3 decimal places	16.1
Automatic Reset	Int	Integral time for PI or PID control. I seconds to 99 minutes 59 seconds and OFF	5.00
Rate (Derivative time)	dEr.t	D term for PD or PID. OFF 0 seconds to 99 minutes 59 seconds	1.15
Overlap / Deadband	O_d	In display units, range -20 to +20% of Heat and Cool Proportional Band	0
ON/OFF differential	d_iFF	On/Off switching point. In display units, centred about the setpoint, range: 0.1% to 10.0% of input span	8

Parameter	Lower	Meaning & Visibility	Default
Loop Alarm Time	LAt	Visible when using On/Off control (i.e. when H_Pb or C_Pb = On,OF) Sets the time to wait before the loop alarm becomes active. Default 99 mins 59 secs. (If PID then the Loop Alarm Time is 2x integral time)	99.59
Manual Reset (Bias)	b,AS	Biasing of Proportional Control output. 0 to 100% (heat only) - 100% to 100% (if heat/cool control)	25
Soft Start Time	SSt	0 (OFF) to 60 hours	OFF
Soft Start Setpoint	SSSP	Soft start target setpoint adjustable between scale input upper and lower limits	-240
Heat Cycle Time	HcYc	Time proportion cycle time for the outputs 0.5 to 5 12.0 seconds	32.0
Cool Cycle Time	CcYc		32.0
Heat & Cool Output Inhibit	OPLC	Inhibits the simultaneous activation of both heat and cool outputs.	OFF
Heat Power Limit	HPL	Heating/Primary % power upper limit 0 to 100%	100
Cool Power Limit	CPL	Cooling/Secondary % power upper limit 0 to 100%	100
Cooling Minimum	COOL	Minimum temperature at which water cooling will activate. Range minimum to range maximum	120
Impulse Length	t.on	1 to 9999 seconds	10
Minimum Off Time	t.off	1 to 9999 seconds	20
Non-linear Cooling Adjust	C.AdJ	0 to 9999 (no units)	5
Power Up Action	PUP LAST On	LAST = Powers up with control enable in the same state as on power fail On = Always powers up with control enabled	LAST
Automatic Tuning Start/Stop	tunE OFF PrE AtSP	OFF = use current PID control terms or manually tune. PrE = start pre-tune AtSP = tune at setpoint	OFF

7.3 Setpoint Sub-menu (SP) “Extrusion” version

Parameter	Lower	Upper / Meaning & Visibility	Default
Setpoint Ramp Rate	rAtE	The rate (in units / hour) from current PV to setpoint following power-up or control enable. From 0.00 to 9999 (Hours.Minutes) or OFF . Setpoint value changes also follow this rate.	OFF
Setpoint Upper Limit	SPuL	The maximum allowed setpoint value, from current setpoint to scaled upper limit.	Upper Limit
Setpoint Lower Limit	SPLl	The minimum allowed setpoint value, from current setpoint to scaled lower limit.	Lower Limit

7.4 Alarm sub-menu (ALr) “Extrusion” version

Parameter	Lower	Upper	Meaning & Visibility	Default
Alarm 1 Type	ALtE	nonE P_h P_Lo dEv bAnd	Set the function of Alarm 1: None, process High, process Low, Deviation or Band	P_h
Alarm 1 Value	AL_1		Set the trigger point / value of Alarm 1 Range minimum to range maximum OFF disables the alarm.	1373
Alarm 1 Hysteresis	HYS1		The Alarm 1 switching point hysteresis 0 to full span.	1
Alarm 2 Type	AL2t		Same options as Alarm 1	P_Lo
Alarm 2 Value	AL_2			-240
Alarm 2 Hysteresis	HYS2			1
Alarm Inhibit	inh1	nonE 1 2 1 2	Inhibit alarms if active at power-up and on change in setpoint. None, Alarm 1, Alarm 2, Alarm 1 & 2.	nonE
Alarm Notification	NotE	nonE 1 2 1 2	Enable alarm notification in the User Mode. Alternating indication -AL- shown when alarms are active. None, Alarm 1, Alarm 2, Alarm 1 & 2.	1 2
Alarm LED Indicator Selection	A_Ind	nonE 1 2 1 2	Select the alarms that will show on the alarm LED indicator. None, Alarm 1, Alarm 2, Alarm 1 & 2.	1 2
Sensor Break Alarm	SbAc	On OFF	On = activates both alarms when a sensor break is detected.	OFF

7.5 Soft Start feature (“Extrusion” version)

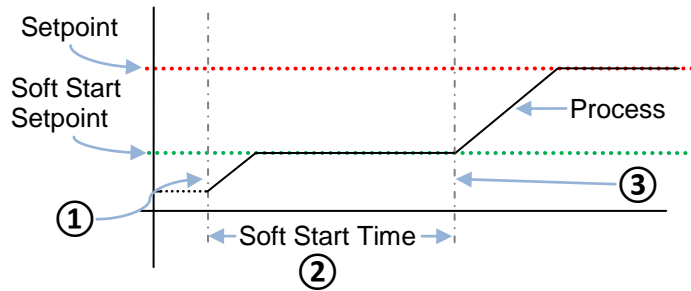

- ① At power on the unit will control to the Soft Start Setpoint, **SSSP**.
- ② Then remain at this value for the time defined by the Soft Start Time, **SSSt**. During this period the control cycle time is a $\frac{1}{4}$ of the value entered and the heat power limit, **HPL**, is used.
- ③ When the soft start timer expires the unit returns to normal operation. The unit controls to the normal setpoint and from this point the heat power limit is not used by the controller.

7.6 Non-linear Cooling feature (“Extrusion” version)

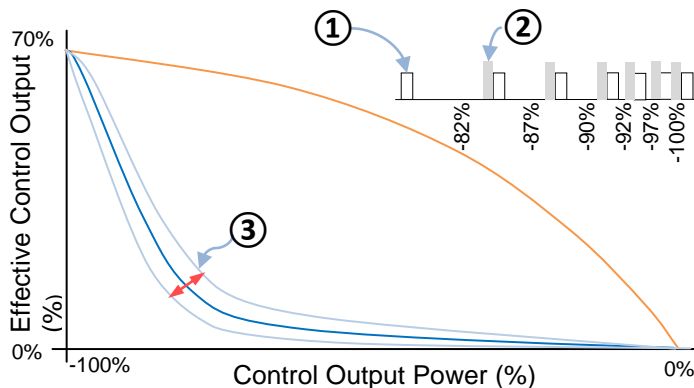

With non-linear cooling, e.g. when using water, the initial cooling effect can be stronger. For example, a change from 0% to -10% output power has more effect than say -70% to -80%. To compensate the cooling curve adjusts the output power so that the effective power over 0% to -70% is weaker.

- ① The length of time the output will be on for is set by the parameter **t.on**.
- ② The minimum time the output will be off for is set by the parameter **t.off**.
- ③ When **C.Adj** is set to a value greater than 0 the cooling is non-linear and the value adjusts the characteristics of the curve.

8 Manually Tuning Controllers

8.1 Single Control Tuning (PID with Heat Output only)

This simple technique balances the need to reach Setpoint quickly, with the wish to limit Setpoint overshoot at start-up, or during process changes.

This method determines values for the Heat Proportional Band (H_Pb), Integral Time Constant ($Int.t$) and Derivative Time Constant ($dEr.t$) that allow the PID control algorithm to give acceptable results in most applications that use a single control device.



This technique is suitable only for processes that are not harmed by large fluctuations in the process variable.

Check that the Setpoint Upper Limit ($SPUL$) and Setpoint Lower Limit ($SPLL$) are set to safe levels for your process. Adjust if required.

Set the Setpoint to the normal operating value for the process (or to a lower value if overshoots beyond this value might cause damage).

Select On-Off control (i.e. set $H_Pb = On.Off$).

Switch on the process. The process variable will oscillate about the Setpoint. Record the Peak-to-Peak variation (P) of the first cycle (i.e. the difference between the highest value of the first overshoot and the lowest value of the first undershoot), and the time period of the oscillation (T) in minutes. See the example diagram below.

Calculate the PID control parameters using the formula below. Input Span is the difference between Scale Range Lower Limit and Scale Range Upper Limit:

$$H_Pb = \frac{P}{\text{Input Span}}$$

$$Int.t = T \text{ minutes}$$

$$dEr.t = \frac{T}{6} \text{ minutes}$$

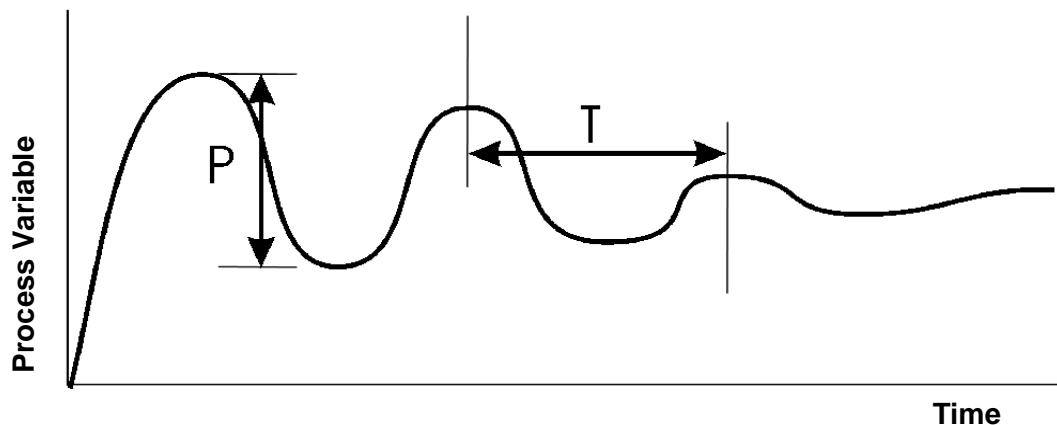

8.2 Manually Tuning PID

Dual Control Tuning (PID with Heat and Cool Outputs)

This simple technique balances the need to reach setpoint quickly, with the wish to limit setpoint overshoot at start-up and during process changes.

This method determines values for the Heat Proportional Band (H_Pb), Cool Proportional Band (C_Pb), Integral Time Constant ($Int.t$) and Derivative Time Constant ($Der.t$) that allow the control algorithm to give acceptable results in most applications that use heating and cooling.



This technique is suitable only for processes that are not harmed by large fluctuations in the process variable.

Tune the controller using only the Heat Control output as described in the Single Control Tuning section above.

Set C_Pb to the same value as H_Pb and monitor the operation of the controller in dual control mode. If there is a tendency to oscillate as the control passes into the Cool Proportional Band, increase the value of C_Pb .

If the process appears to be over-damped in the region of the Cool Proportional Band, decrease the value of C_Pb .

When the PID tuning values have been determined, if there is a kick to the process variable as control passes from one output to the other, set the Overlap/Deadband parameter to a positive value to introduce some overlap. Adjust this value by trial and error until satisfactory results are obtained.

8.3 Manually Fine Tuning the PID Settings

A separate cycle time adjustment parameter is provided for each time proportioning control output.

 Adjusting the cycle time affects the controller's operation; a shorter cycle time gives more accurate control but electromechanical components such as relays have a reduced life span.

Increase the width of the proportional band if the process overshoots or oscillates excessively.

Decrease the width of the proportional band if the process responds slowly or fails to reach Setpoint.

Increase the automatic reset (integral) until the process becomes unstable, then decrease until stability has been restored.

 Allow enough time for the controller and process to adjust.

Initially add rate at a value between $1/4^{\text{th}}$ and $1/10^{\text{th}}$ of the automatic reset value. Decrease Rate if the process overshoots/undershoots or oscillates excessively.

9 Calibration Mode

It is possible to calibrate the controller to compensate for sensor errors and other tolerance errors in the system. This is achieved using the calibration mode.

The calibration mode allows an offset to be applied in two different ways. The method used will be dependent on the process application. However please note that both methods can be used together. I.e. you can use the single point to offset the zero point and the two-point calibration to change the calibration slope.

9.1 Single point calibration (PV Offset)

This is a 'zero offset' applied to the process variable across the entire span. Positive values are added to the reading; negative values are subtracted.

This can be used if the error is constant across the range, or the user is only interested in a single critical value.

To use, select Single Point Calibration from the input calibration menu, and simply enter a value equal, but opposite to the observed error to correct the reading.

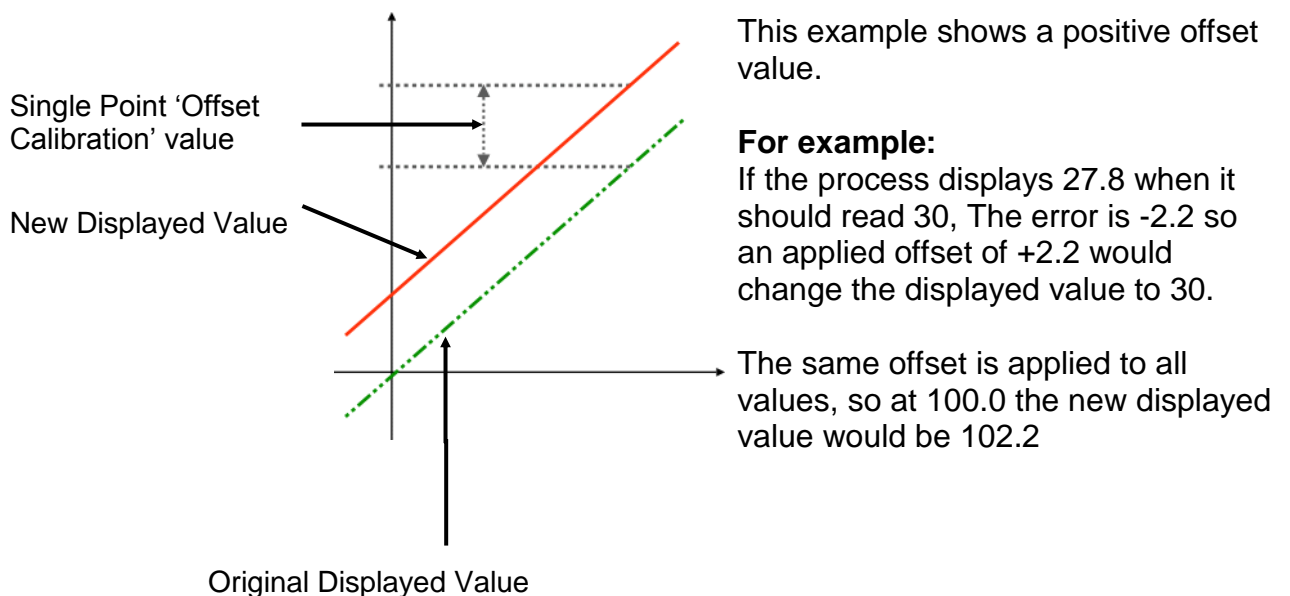

9.2 Two Point Calibration

This method is used where an error is not constant across the range. Separate offsets are applied at two points in the range to eliminate both “zero” and “span” errors.

1. Measure and record the error at a low point in the process.
2. Measure and record the error at a high point in the process.
3. Go to the first two-point input calibration screen.
 - a. Enter the desired low point value as the Calibration Low PV value.
 - b. Enter an equal, but opposite value to the observed error as the Calibration Low Offset to correct the error at the low point.
4. Go to the second two-point input calibration screen.
 - a. Enter the desired high point as the Calibration High PV value.
 - b. Enter an equal, but opposite value to the observed error as the Calibration High Offset to correct the error at the high point.

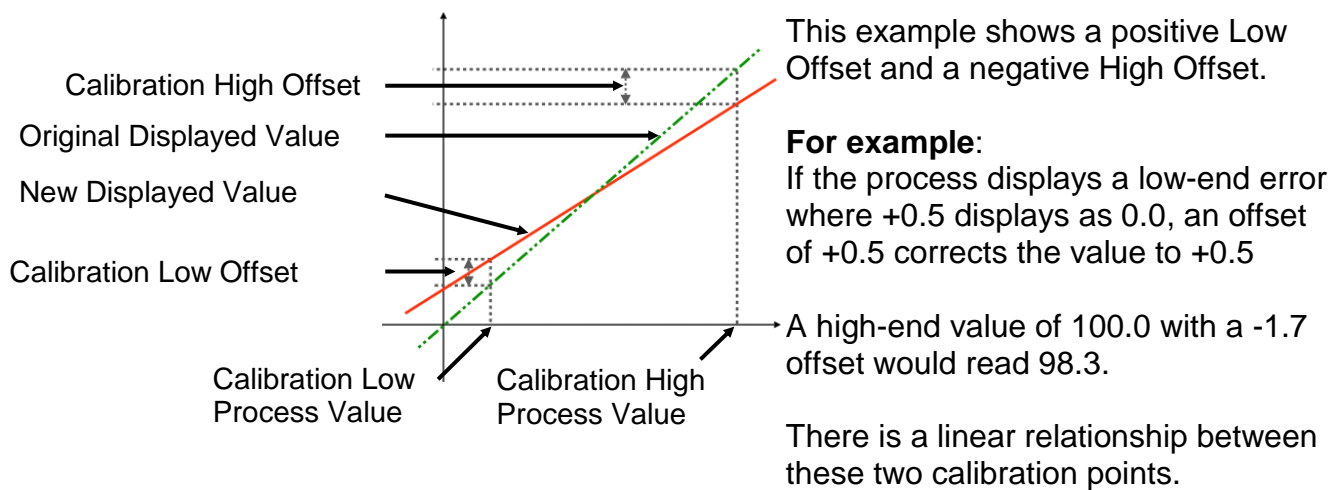

CAUTION: Choose values as near as possible to the bottom and top of your usable span to achieve maximum calibration accuracy. The effect of any error can grow at values beyond the chosen calibration points.

10 Serial Communications

10.1 Supported Protocol

The unit supports Modbus RTU protocol through the RS485 interface.

For a complete description of the Modbus protocol refer to the description provided at <http://www.modbus.org/>

10.2 RS485 Configuration

The RS485 address, bit rate and character format are configured via the front panel from the Communications Sub-menu.

Data rate:	4800, 9600 (default), 19200 or 38400 bps
Parity:	None (default), Even or Odd
Character format:	Fixed as 8 bits per character (1 byte)
Device Address:	See RS485 Device Addressing



To communicate successfully the master device must have matching values for the Data rate, Parity and Character format parameters.

10.3 RS485 Device Addressing

Each slave instrument must be assigned a unique device address in the range 1 to 255. This address is used to recognise Modbus Queries intended for this instrument. Apart from globally addressed broadcast messages, the instrument ignores Modbus Queries that do not match the address that has been assigned to it.

The instrument will accept broadcast messages (global queries) using device address 0 no matter what device address is assigned. No response messages are returned for globally addressed queries.

10.4 Link Layer

A Query (or command) is transmitted from the Modbus Master to the Modbus Slave. The slave instrument assembles the reply to the master.

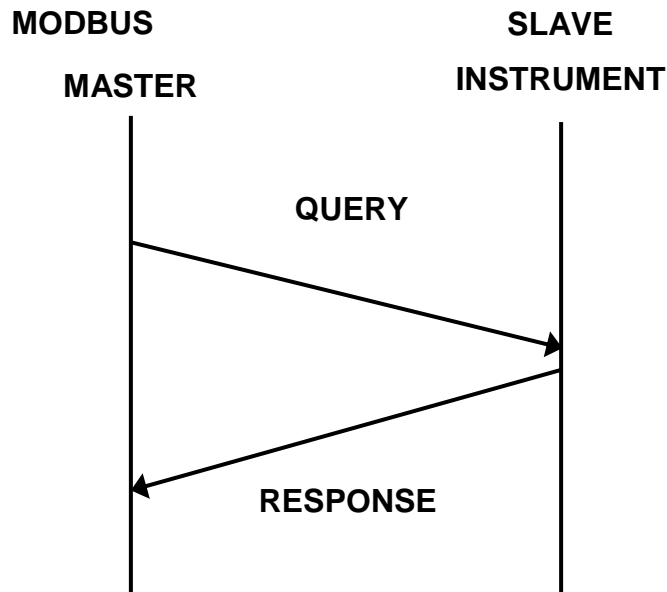

A message for either a QUERY or RESPONSE is made up of an inter-message gap followed by a sequence of data characters. The inter-message gap is at least 3.5 data character times - the transmitter must not start transmission until 3 character times have elapsed since reception of the last character in a message, and must release the transmission line within 3 character times of the last character in a message.



Three character times is approximately 0.75ms at 38400 bps, 1.5ms at 19200 bps, 3ms at 9600 bps and 6ms at 4800bps.

Data is encoded for each character as binary data, transmitted LSB first.

For a QUERY the address field contains the address of the slave destination. The slave address is given together with the Function and Data fields by the Application layer. The CRC is generated from the given address, function and data characters.

For a RESPONSE the address field contains the address of the responding slave. The Function and Data fields are generated by the slave application. The CRC is generated from the address, function and data characters.

The standard MODBUS RTU CRC-16 calculation employing the polynomial $2^{16}+2^{15}+2^2+1$ is used.

Inter-message gap	Address 1 character	Function 1 character	Data <i>n</i> characters	CRC Check 2 characters
-------------------	------------------------	-------------------------	-----------------------------	---------------------------

10.5 Supported Modbus Functions

Modbus defines several function types.

The following types are supported by this instrument:

Function Code decimal (hex)	Modbus Meaning	Description
03 (0x03) 04 (0x04)	Read Holding / Input Registers	Read current binary value of specified number of parameters at given address. Up to 64 parameters can be accessed with one query.
06 (0x06)	Write Single Register	Writes 2 bytes to a specified word address.
08 (0x08)	Diagnostics	Used for loopback test only to check the communications work.
16 (0x10)	Write Multiple Registers	Writes up to 253 bytes of data to the specified address range.

10.6 Function Descriptions

The following is interpreted from the Modbus Protocol Description obtainable from <http://www.modbus.org/>.

In the function descriptions below, the preceding device address value is assumed, as is the correctly formed two-byte CRC value at the end of the QUERY and RESPONSE frames.

Function 03 / 04 - Read Holding/Input Registers

Reads the current binary value of data at the specified word addresses.

QUERY

Function	Address of 1 st Word		Number of Words	
03 / 04	HI	LO	HI	LO

RESPONSE

Function	Number of Bytes	First Word		Last Word	
03 / 04	n	HI	LO	HI	LO

In the response the “Number of Bytes”, n, indicates the number of data bytes read from the instrument. E.g. if 5 words are read, the count will be 10 (A hex). The maximum number of words that can be read is 64. If a parameter does not exist at one of the addresses read, then a value of 0000h is returned for that word.

Function 06 – Write Single Register

QUERY

Function	Diagnostic Code		Value	
06	HI =00	LO=00	HI	LO

RESPONSE

Function	Sub-function	Value		
06	HI=00	LO=00	HI	LO

Function 08 - Loopback Diagnostic Test

QUERY

Function	Diagnostic Code		Value	
08	HI =00	LO=00	HI	LO

RESPONSE

Function	Sub-function		Value	
08	HI=00	LO=00	HI	LO



The Response normally returns the same data as the loopback query itself and so can be used to test the communications. Other Diagnostic Codes are not supported.

Function 16 (0x10 Hex) - Write Multiple Registers

Writes consecutive word (two-byte) values starting at the specified address.

QUERY

Function	1 st Write Address		Number of Words to Write		Number of Query Bytes	1 st Query Byte	2 nd Query Byte	etc	Last Query Byte
10	HI	LO	HI	LO				→	

RESPONSE

Function	1 st Word Address		Number of Words	
10	HI	LO	HI	LO



The number of data bytes that can be written in one message is 253 bytes.

11 Modbus Addresses

11.1 Input parameters

Parameter Name	Modbus Address (Dec)	Modbus Address (Hex)	Access R/W	Notes	Default	
Process Variable	1070	42E	RO		n/a	
Input Filter	1004	3EC	R/W	0 to 100 seconds	0.5s	
CJC Enable	1006	3EE	R/W	0 = Off 1 = On	1	
Input units	1005	3ED	R/W	0 = Deg C 1 = Deg F	0	
Decimal point position	1003	3EB	R/W	Value	Range	0
				0	XXXX 0 D.P.	
				1	XXX.X 1 D.P.	
				2	XX.XX 2 D.P.	
				3	X.XXX 3 D.P.	
Scaled range lower limit	1002	3EA	R/W		-200	
Scaled range upper limit	1001	3E9	R/W		1372	
Input Status	1071	42F	RO		N/A	



Input Type	1000	3E8	R/W	Value	Range	1
				0	J Thermocouple	
				1	K Thermocouple	
				2	PT100	
				3	B Thermocouple	
				4	C Thermocouple	
				5	L Thermocouple	
				6	N Thermocouple	
				7	R Thermocouple	
				8	S Thermocouple	
				9	T Thermocouple	
				10	0 – 20mA	
				11	4 – 20mA	
				12	0 – 50mA	
				13	10 – 50mA	
				14	0 – 5V	
				15	1 – 5V	
				16	0 – 10V	
17	2 – 10V					
Sensor break status	1072	430	RO	0 = Ok 1 = Sensor break	N/A	
Under range status	1073	431	RO	0 = Ok 1 = Under range	N/A	
Over range status	1074	432	RO	0 = Ok 1 = Over range	N/A	

11.2 User Calibration

Parameter Name	Modbus Address (Dec)	Modbus Address (Hex)	Access R/W	Notes	Default
Single Point Offset	1601	641	R/W	+/- Span	0
Low calibration point	1602	642	R/W	Input range maximum to input range minimum.	Range minimum
Low offset	1603	643	R/W	+/- Span	0
High calibration point	1604	644	R/W	Input range maximum to input range minimum.	Range minimum
High offset	1605	645	R/W	+/- Span	0

11.3 Auto Calibration

Parameter Name	Modbus Address (Dec)	Modbus Address (Hex)	Access R/W	Notes	Default
50mV Auto Calibration	1700	6A4	WO	Write 0xCAFE to start auto calibration	N/A
10V Auto Calibration	1701	6A5			
20mA Auto Calibration	1702	6A6			
RTD Auto Calibration	1703	6A7			
CJC Auto Calibration	1704	6A8			
Auto Calibration Status	1770	6EA	RO	0x0000 = Calibration Fail 0xCAFE = Calibration Busy 0xFFFF = Calibration Pass	

11.4 Output Option 1 parameters

Parameter Name	Modbus Address (Dec)	Modbus Address (Hex)	Access R/W	Notes	Default
Output Usage	1100	44C	R/W	0 = Heat Output 1 = Cool Output 2 = Non-Linear Cooling 3 = Alarm 1 4 = Alarm 2 5 = Alarm 1 or Alarm 2	1
Output LED Invert	1101	44D	R/W	0 = Sync with output 1 = Opposite to output	0
Output Alarm Action	1102	44E	R/W	0 = Direct 1 = Reverse	0
Output Alarm Latch	1103	44F	R/W	0 = Off 1 = On	0

11.5 Output Option 2 parameters

Parameter Name	Modbus Address (Dec)	Modbus Address (Hex)	Access R/W	Notes	Default
Output Usage	1120	460	R/W	0 = Heat Output 1 = Cool Output 2 = Non-Linear Cooling 3 = Alarm 1 4 = Alarm 2 5 = Alarm 1 or Alarm 2	1
Output LED Invert	1121	461	R/W	0 = Sync with output 1 = Opposite to output	0

Output Alarm Action	1122	462	R/W	0 = Direct 1 = Reverse	0
Output Alarm Latch	1123	463	R/W	0 = Off 1 = On	0

11.6 Output Option 3 parameters

Parameter Name	Modbus Address (Dec)	Modbus Address (Hex)	Access R/W	Notes	Default
Output Usage	1130	46A	R/W	0 = Heat Output 1 = Cool Output 2 = Non-Linear Cooling 3 = Alarm 1 4 = Alarm 2 5 = Alarm 1 or Alarm 2	1
Output LED Invert	1131	46B		0 = Sync with output 1 = Opposite to output	0
Output Alarm Action	1132	46C		0 = Direct 1 = Reverse	0
Output Alarm Latch	1133	46D		0 = Off 1 = On	0



11.7 Control

Parameter Name	Modbus Address (Dec)	Modbus Address (Hex)	Access R/W	Notes	Default
Heat Proportional Band	1302	516	R/W	0 (ON/Off) or 0.1 to 9999	10
Cool Proportional Band	1303	517		0 (ON/Off) or 0.1 to 9999	10
Integral	1304	518		0 (Off) or 1 to 9999	75
Derivative	1305	519		0 (Off) or 1 to 9999	15
Overlap	1306	51A		-20% to 20% of primary and secondary proportional band	0
Manual Reset	1307	51B		0% (-100% for dual control) to 100%	25
Differential	1308	51C		0.1% to 10.0% of input span	8
Heat Power Limit	1311	51F		0 to 100	100
Cool Power Limit	1312	520		0 to 100	100
Control Enable/Disable	1375	55F		0 = Control Disabled 1 = Control Enabled	1
Control Enable state	1376	560	RO	0 = Control Disabled 1 = Control Enabled	N/A
Manual Power Enable	1315	523	R/W	0 = Automatic Control 1 = Manual Control	0
Combined Power	1316	524	RO	-100 to 100	N/A
Heat Power	1370	55A	RO	0 to 100	N/A
Cool Power	1371	55B	RO	0 to 100	N/A



Parameter Name	Modbus Address (Dec)	Modbus Address (Hex)	Access R/W	Notes	Default
Loop Alarm Status	1372	55C	RO	0 = Inactive 1 = Active	N/A
Power-up Action	1377	561	R/W	0 = As switch off 1 = Always power on	0
Heat Cycle Time	1317	562	R/W		32.0
Cool Cycle Time	1318	563	R/W		32.0



Non-Linear Cooling parameters (extrusion model)

Parameter Name	Modbus Address (Dec)	Modbus Address (Hex)	Access R/W	Notes	Default
Minimum Cooling Temperature	1380	564	R/W	Range minimum to range maximum	120
Impulse Length	1381	565		0.01 to 9999	0.1
Minimum Off Time	1382	566		0.1 to 9999	2.0
Cooling Adjust	1383	567		0.0 to 9999	0.5
Tuning Type	1384	568		0 = No 1 = Yes	0

11.8 Setpoint

Parameter Name	Modbus Address (Dec)	Modbus Address (Hex)	Access R/W	Notes	Default
Setpoint	1200	4B0	R/W		Range minimum
Setpoint maximum	1201	4B1	R/W		Range minimum
Setpoint Minimum	1202	4B2	R/W		Range minimum
Setpoint ramp rate	1204	4B4	R/W		Off
Actual Setpoint	1270	4F6	RO		NA
Timer Enable	1275	4FB	R/W	0 = Off 1 = On	0
Timer Delay Time	1276	4FC	R/W	0 to 9999 minutes	Off
Timer On Time	1277	4FD	R/W	0 to 9999 minutes	Off
Timer remaining delay time	1278	4FE	RO		N/A
Timer remaining on time	1279	4FF	RO		N/A

11.9 Alarm parameters

Parameter Name	Modbus Address (Dec)	Modbus Address (Hex)	Access R/W	Notes	Default
Alarm 1 Type	1400	578	R/W	0 = None 1 = High Alarm 2 = Low Alarm 3 = Deviation 4 = Band	1
Alarm 1 Value	1402	57A	R/W	Limited by the input range maximum and minimum.	Off



Parameter Name	Modbus Address (Dec)	Modbus Address (Hex)	Access R/W	Notes	Default
Alarm 1 Hysteresis	1403	57B	R/W	Limited by the span of the input range	10
Alarm 2 Type	1404	57C	R/W	0 = None 1 = High Alarm 2 = Low Alarm 3 = Deviation 4 = Band	2
Alarm 2 Value	1406	57E	R/W	Limited by the input range maximum and minimum.	Off
Alarm 2 Hysteresis	1407	57F	R/W	Limited by the span of the input range	10
Alarm Notification	1408	580	R/W	0 = None 1 = Alarm 1 2 = Alarm 2 3 = Alarm 1 and Alarm 2	3
Sensor Break Activates alarms	1409	581	R/W	0 = Off 1 = On	0
Alarm Inhibit	1410	582	R/W	0 = None 1 = Alarm 1 2 = Alarm 2 3 = Both Alarms	0
Alarm LED Disabled	1411	583	R/W	0 = Off 1 = On	1
Alarm 1 Status	1470	5BE	RO	0 = Inactive 1 = Active	N/A
Alarm 2 Status	1471	5BF	RO	0 = Inactive 1 = Active	N/A

11.10 Display parameters

Parameter Name	Modbus Address (Dec)	Modbus Address (Hex)	Access R/W	Notes	Default
Setup Mode Lock Code	1804	70C	R/W	Default 10	10
Advanced Mode Lock Code	1803	70B		Default 10	20
Basic Setpoint Control Enable	1805	70D		0 = Standard 1 = Basic	0
Indicator Enable/Disable	1806	70E		0 = Standard 1 = Indicator Mode	0

11.11 Communications

Parameter Name	Modbus Address (Dec)	Modbus Address (Hex)	Access R/W	Notes	Default
Modbus Address	1500	5DC	R/W	1 to 255	1
Parity	1501	5DD		0 = None 1 = Even 2 = Odd	0
Baud rate	1502	5DE		0 = 1200 1 = 2400 2 = 4800 3 = 9600 4 = 19200 5 = 38400	3



11.12 Manufacturing Information

Parameter Name	Modbus Address (Dec)	Modbus Address (Hex)	Access R/W	Notes	Default
Manufacturing ID	500	1F4	RO		N/A
Equipment ID	501	1F5			
Serial Number Low	502	1F6			
Serial Number Mid	503	1F7			
Serial Number High	504	1F8			
Date Of Manufacture	505	1F9			
Product Revision Level	506	1FA			
Firmware Version	507	1FB			
Product ID	508	1FC			

12 Device Configurator PC Software

Input Main	
Input Type	K Thermocouple
Input Unit	C
Input Decimal Position	0000
Input Scale Range Upper	1373
Input Scale Range Lower	-240
Input Filter Time	0.0
Input CJC Enable	ON

Input User Calibration	
Single Point Offset	0
Low Calibration Point	-240
Low Calibration Offset	0
High Calibration Point	1373
High Calibration Offset	0

12.1 Features

- Device menus are clearly laid out on the left with the relevant parameters on the right.
- Parameter sets can be Loaded, Saved or Printed using the icons.
- Parameters can be Uploaded to and Downloaded from the device using the icons.
- Setup wizard simplifies the setting up of the device.
- Can be used via the dedicated configuration port on the bottom or via the optional RS485 if fitted.

Please note the dedicated configuration socket is similar to a micro USB socket but should never be directly connected to a USB port or USB charger. Use of this socket requires the USB port to configuration socket adaptor, available from your supplier.



***Note:** .Net 4.0 must be installed to use with Windows XP.

12.2 Brief Guide to Starting the Software



Make sure you select the correct model when you start the software:



Click on **Read from Device** button on the bottom left. The Configuration Port option is fitted to all MaxVU instruments and requires a special cable available from your supplier.

Model	Firmware Name
Standard	V227A_Encrypt.s19
Extrusion	V227B_Encrypt.s19

13 Thermocouple Identification and Ranges

Thermocouples are identified by wire sleeve colour and the outer insulation colour as well. There are several standards in use throughout the world and this is not an exhaustive list.

Type		International IEC584-3	USA ANSI MC 96.1	British BS1843	French NFC 42-324	German DIN 43710
J	+ *	Black Black	White Black	Yellow Black	Yellow Black	Red Blue
	-	White Black	Red Black	Blue Black	Black	Blue
T	+	Brown Brown	Blue Blue	White Blue	Yellow Blue	Red Brown
	-	White Brown	Red Blue	Blue Blue	Blue	Brown Brown
K	+	Green Green	Yellow Yellow	Brown Red	Yellow Yellow	Red Green
	- *	White Green	Red Yellow	Blue Red	Purple Yellow	Green Green
N	+	Pink Pink	Orange Orange	Orange Orange		
	-	White Pink	Red Orange	Blue Orange		
B	+	Grey Grey	Grey Grey			Red Grey
	-	White Grey	Red Grey			Grey
R & S	+	Orange Orange	Black Green	White Green	Yellow Green	Red White
	-	White Orange	Red Green	Blue Green	Green Green	White White
C (W5)	+		White White			
	-		Red White			

Note:

* = Wire is magnetic

+ Wire	Sheath
- Wire	

Type	Ranges Supported	
J thermocouple	-200 to 1200°C (-328 to 2192°F)	-128.8 to 537.7°C (-199.9 to 999.9°F)
K thermocouple	-240 to 1373°C (-400 to 2503°F)	-128.8 to 537.7°C (-199.9 to 999.9°F)
PT100	-199 to 800°C (-328 to 1472°F)	-128.8 to 537.7°C (-199.9 to 999.9°F)
B thermocouple	100 to 1824°C (211 to 3315°F)	
C thermocouple	0 to 2320°C (32 to 4208°F)	
L thermocouple	0 to 762°C (32 to 1403°F)	0.0 to 537.7°C (32.0 to 999.9°F)
N thermocouple	0 to 1399°C (32 to 2551°F)	
R thermocouple	0 to 1795°C (32 to 3198°F)	
S thermocouple	0 to 1762°C (32 to 3204°F)	
T thermocouple	-240 to 400°C (-400 to 752°F)	-128.8 to 400.0°C (-199.9 to 752.0°F)

14 Specifications

Universal Input	
Please see note * under Environmental specifications.	
Thermocouple Calibration	$\pm 0.25\%$ of full range, $\pm 0.4\%$ of full range below 110°C with 1dp ranges, $\pm 1\text{LSD}$ ($\pm 1^{\circ}\text{C}$ for Thermocouple CJC). BS4937, NBS125 & IEC584.
PT100 Calibration	$\pm 0.25\%$ of full range, $\pm 0.4\%$ of full range above 520°C with 1dp ranges, $\pm 1\text{LSD}$. BS1904 & DIN43760 ($0.00385\Omega/\Omega/^{\circ}\text{C}$).
DC Calibration	+/- 0.2% of full range, +/- 1LSD.
Sampling Rate	4 per second.
Impedance	$>10\text{M}\Omega$ resistive, except DC mA (5Ω) and V ($47\text{k}\Omega$).
Sensor Break Detection	Thermocouple, RTD, 4 to 20mA, 2 to 10V and 1 to 5V ranges only. Control outputs turn off.
Isolation	Isolated from all outputs (except SSR driver) by at least BASIC isolation. The input must not be connected to operator accessible circuits if relay outputs are connected to a hazardous voltage source. Supplementary insulation or input grounding would then be required. Isolated from Mains Power Input by basic isolation.

Outputs	
RELAYS (OPTIONAL)	
Contacts	SPST Form A relay; current capacity 2A at 250VAC.
Lifetime	$>150,000$ operations at rated voltage/current, resistive load.
Isolation	Basic Isolation from universal input and SSR outputs.
SSR Drivers (OPTIONAL)	
Drive Capability	SSR drive voltage $>10\text{V}$ at 20mA
Isolation	Not isolated from the input or other SSR driver outputs.

Serial Communications (Optional)	
Physical	RS485, at 1200, 2400, 4800, 9600, 19200 or 38400 baud.
Protocols	Modbus RTU.
Isolation	Basic safety isolation from Universal input and SSR. Basic safety isolation to Mains and Relay Circuits.

Operating Conditions	
Usage	For indoor use only, mounted in suitable enclosure.
Ambient Temperature	0°C to 55°C (Operating), -20°C to 80°C (Storage).
Relative Humidity	20% to 95% non-condensing.
Altitude	<2000m
Supply Voltage & Power	100 to 240VAC +/- 10% 50/60Hz 7.5VA (for mains powered versions) or 24VAC +10 / -15% 50/60Hz 7.5VA or 24VDC +10 / -15% 5W (for low voltage versions).

Environmental	
Standards	CE, UL & cUL
EMI	Complies with EN61326-1:2013 - Table 2 Immunity & Class A Emissions.
<p>This is a Class A product. In a domestic environment, this product may cause radio interference in which case the user may be required to take adequate measures.</p> <p>*Accuracy of universal input is degraded to 2% of full span if users have RF transmitters producing AM field strengths of 10V/m or more, between frequencies of 400-600MHz and within 3m of an unshielded MaxVU unit. Users are advised to shield MaxVU by placing it behind a metal enclosure or re-position away from the transmitter.</p>	
Safety Considerations	Complies with UL61010-1 Edition 3, Pollution Degree 2 & Installation Category II.
IP Rating (Sealing)	Front to IP65 when correctly mounted. Rear of panel to IP20.

Physical	
Front Bezel Size	1/16 Din = 48 x 48 mm 1/8 Din = 48 x 96 mm
Depth Behind Panel	67mm with sealing gasket fitted.
Weight	0.20kg maximum

15 Glossary

Actual Setpoint

Actual Setpoint is the current effective value of the Setpoint. This may be different to the Active Setpoint's target value if the Setpoint is currently ramping. The actual Setpoint will rise or fall at the ramp-rate set, until it reaches the target Setpoint value.
 Also refer to *Active Setpoint*, *Setpoint*, *Setpoint Ramp Enable*.

Alarm Hysteresis

An adjustable band on the "safe" side of an alarm point, through which the process variable must pass before the alarm will change state, as shown in the diagram below.
 Also refer to *Alarm Operation*.

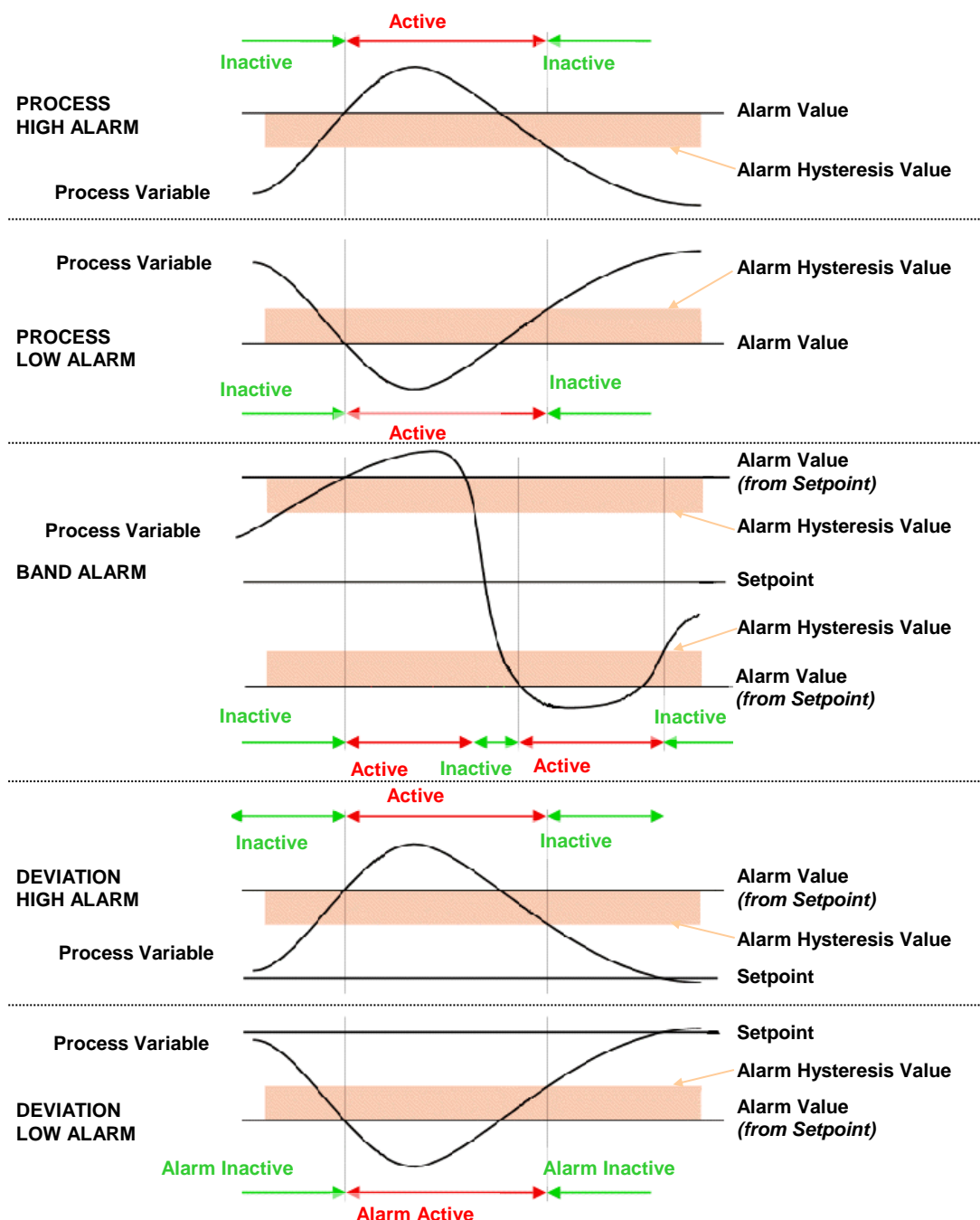

Alarm Operation

The different alarm types are shown below, together with the action of any outputs. Also refer to *Alarm Hysteresis*, *Alarm Inhibit*, *Band Alarm*, *Deviation Alarm*, *Latching Relay*, *Logical Alarm Combinations*, *Loop Alarm*, *Process High Alarm* and *Process Low Alarm*.

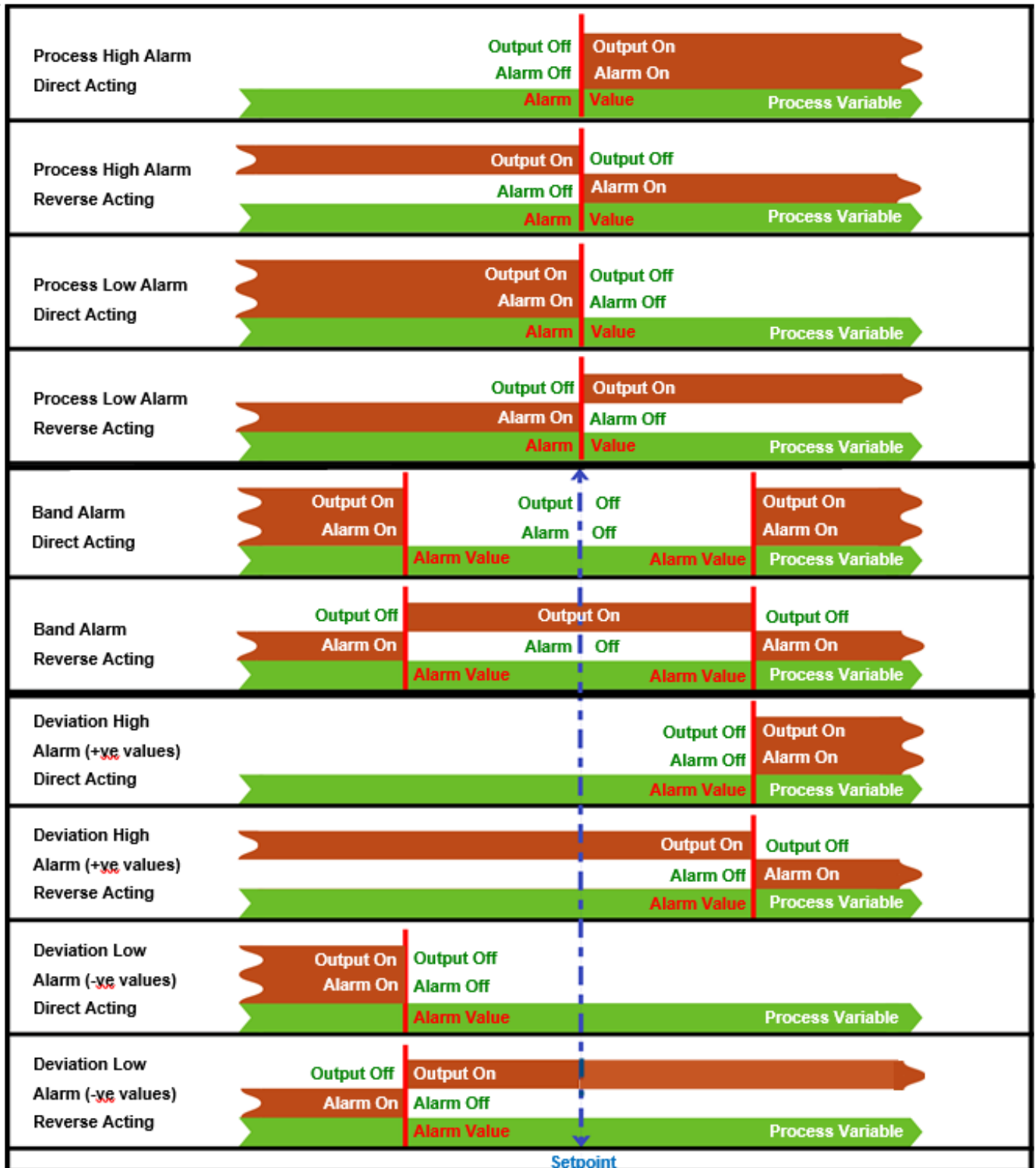



Alarm Inhibit

Inhibits an alarm at power-up or when the controller Setpoint is changed, until that alarm goes inactive. The alarm operates normally from that point onwards.

Also refer to Alarm Operation.

Automatic Reset (Integral)

Used to automatically bias the proportional output(s) to compensate for process load variations. It is adjustable in the range 1 seconds to 99 minutes 59 seconds per repeat and OFF (value greater than 99 minutes 59 seconds - display shows **OFF**). Decreasing the time increases the Integral action. This parameter is not available if the primary output is set to On-Off.

Also refer to Heat Proportional Band, Cool Proportional Band, Rate, PID, and Tuning.

Auto-Tune

Refer to Pre-Tune and Tune at Setpoint..

Band Alarm Value

This parameter is applicable only if an Alarm is selected to be a Band Alarm. It defines a band of process variable values, centred on the current actual Setpoint value. If the process variable value is outside this band, the alarm will be active. This parameter may be adjusted from 1 to full span from the Setpoint.

Also refer to Alarm Operation and Input Span.

Basic Setpoint Control

When Basic Setpoint Control is enabled the user can only change the set point or the power from the User mode screen. To change other settings the user must enter the Advanced Configuration Mode. Parameter is found in the Display sub-menu.

Bias (Manual Reset)

Used to manually bias the proportional output(s) to compensate for process load variations. Bias is expressed as a percentage of output power and is adjustable in the range 0% to 100% (for Heat Output alone) or -100% to +100% (for both Primary and Cool Outputs). This parameter is not applicable if the Primary output is set to ON/OFF control mode. If the process settles below Setpoint use a higher Bias value to remove the error, if the process variable settles above the Setpoint use a lower Bias value. Lower Bias values will also help to reduce overshoot at process start up.

Also refer to ON/OFF Control and PID.

Bumpless Transfer

A method used to prevent sudden changes to the output power level when switching between Automatic and Manual control modes. During a transition from Automatic to Manual, the initial Manual Power value will be set to equal the previous automatic mode value. The user can then adjust the value as required.

During a transition from Manual to Automatic, the initial Automatic Power value will be set to equal the previous manual mode value. The correct power level will gradually applied by the control algorithm at a rate dependant on the integral action resulting from the Automatic Reset time. Since integral action is essential to Bumpless Transfer, this feature is not available if Automatic Reset is turned off.

Also refer to Automatic Reset (Integral) and Manual Mode

Calibration - 2 Point (High/Low PV Offset)

Two point calibration uses two separate points of reference, usually at the process high and low operating limits to determine the required offsets. These offsets are used to rescale all readings over the full range of the controller minimising inaccuracies in the input reading.

Refer to User Calibration Type.

Calibration - Single Point (PV Offset)

Single point calibration uses a single point of reference, usually at the operating process value to determine the required calibration offset. This offset is then applied to all measurements throughout the span of the controller.

Refer to User Calibration Type.

Control Type

This is selected by using the Out 1, Out 2 and Out 3 parameters. Heat is reverse action and Cool is direct action as more cooling is required when the temperature (PV) rises.

Refer to PID, Heat Proportional Band, Process Variable and Cool Proportional Band.

Controller

An instrument that can control a Process Variable, using either PID or On-Off control methods. Alarm outputs are also available that will activate at preset PV values, as are other options and Serial Communications.

Refer to Alarm Operation, Indicator, Limit Controller, On-Off Control, PID, Process Variable and Serial Communications.

Cool Proportional Band

The portion of the input span over which the Cool Output power level is proportional to the process variable value. It may be adjusted in range units equivalent to 0.5% to 999.9%, or ON.OFF of the input span. The Control action for the Cool Output is always the opposite of the Heat output.

The Cool Proportional Band is only applicable when the Cool Output is used.

Refer to Control Type, On-Off Control, Input Span, Overlap/Deadband, PID, Heat Proportional Band and Tuning.



Cycle Time

For time proportioning outputs, cycle time is used to define the time period over which the average on vs. off time is equal to the required PID output level. **Hcyc** and **Ccyc**, are available when the Heat or Col outputs are defined as time proportioning output types. The permitted range of values is 0.1 to 512 seconds in 0.1s steps. Shorter cycle times will give better control, but at the expense of reduce life when used with an electromechanical control device (e.g. relays or solenoid valves).

Also refer to PID and Time Proportioning.

Deadband

Refer to *Overlap/Deadband*.

Derivative

Refer to *Rate*.

Deviation Alarm

This is applicable only if Alarm is selected to be Deviation Alarm. A positive value (Deviation High) sets the alarm point above the current actual Setpoint, a negative value (Deviation Low) sets it below. If the process variable deviates from the Setpoint by a margin greater than this value, alarm 1 becomes active.

Also refer to Alarm Operation.

Differential (On-Off Hysteresis)

A switching differential used when one or both control outputs have been set to On-Off. This parameter is adjustable in range units within the range 0.1% to 10.0% of input span; the default value is 0.5% in units. The differential band is centred about the Setpoint. Relay chatter can be eliminated by proper adjustment of this parameter. Too large a value for this parameter will increase amplitude of oscillation in this process variable.

Also refer to Input Range and Input Span and On-Off Control.

Heat or Cool Output Power Limit

Used to limit the power level of the Heat or Cool Outputs and may be used to protect the process being controlled. It may be adjusted between 0% and 100%. This parameter is not applicable if the primary output is set for On-Off control.

Also refer to On-Off Control.

Heat Proportional Band

The portion of the input span over which the Heat Output power level is proportional to the process variable value. It may be adjusted in range units equivalent to 0.5% to 999.9%, or ON.OFF of the input span.

Also refer to Control Type, On-Off Control, Input Span, Overlap/Deadband, PID, Cool Proportional Band, and Tuning.

High Calibration Point

This parameter is used to define the high calibration point when the two point calibration method is used to calibrate the controller.

Also refer to Two Point Calibration and High Offset.

High Offset

This parameter is used to define the high point offset value when the two point calibration method is used to calibrate the controller. This value is applied to the high calibration point.

Also refer to Two Point Calibration, High Calibration Point.

Input Filter Time Constant

This parameter is used to filter out extraneous impulses on the process variable. The filtered PV is used for all PV-dependent functions (display control, alarm etc). The time constant is adjustable from 0.0 seconds (off) to 100.0 seconds in 0.5 second increments.

Also refer to Process Variable.

Input Range and Input Span

The Input Range is the overall non-restricted range as determined by the **TYPE** parameter in the input sub-menu.

The Input Span (or Scaled Range) is the limited working range set by the upper and lower limits in the input sub-menu. The input span is used as the basis for calculations that relate to the span of the instrument (E.g. controller proportional bands).

Also refer to Scale Range Upper Limit and Scale Range Lower Limit

Integral Time

Refer to *Automatic Reset*.

Latching Relay

A type of relay that, once it becomes active, requires a reset signal before it will deactivate. This output is available on Limit controllers and indicator alarms. To successfully deactivate a latched relay, the alarm or limit condition that caused the relay to become active must first be removed, and then a reset signal can be applied. This signal may be applied from the instrument keypad, or command via Serial Communication.

Also refer to Alarm Operation, Indicator, Limit Controller, Limit Hysteresis, Serial Communications.

Light Emitting Diode (LED)

A Light Emitting Diode or LED is used as an indicator light (e.g. for the alarm indication). The upper and lower 7-segment displays are formed from LEDs.

Limit Controller

A protective device that will shut down a process at a preset Exceed Condition, in order to prevent possible damage to equipment or products. They are recommended for any process that could potentially become hazardous under fault conditions.

Loop Alarm

A loop alarm is a special alarm, which detects faults in the control feedback loop, by continuously monitoring the process variable response to the control output(s).

The loop alarm can be tied to any suitable output. When enabled, the loop alarm repeatedly checks if the control output(s) are at the maximum or minimum limit (when dual output).

Control output limits are 100% for Single output (Heat only) controllers and -100% (Cool) & 100% (Heat) for Dual output (Heat & Cool) controllers. If the HPL heat power limit or CPL cool power limit parameters are less than 100% then they will apply as the limit instead of 100%. E.g. if HPL is 70% then the limit used for the loop alarm will be 70%.

If an output is at the limit, an internal timer is started: thereafter, if the high output has not caused the process variable to be corrected by a predetermined amount 'V' after time 'T' has elapsed, the loop alarm becomes active.

Subsequently, the loop alarm mode repeatedly checks the process variable and the control output(s). When the process variable starts to change value in the correct sense or when the output is no longer at the limit, the loop alarm is deactivated.

For PID control, the loop alarm time 'T' is always twice the Automatic Reset (Integral) parameter value. For On-Off control, a user defined value for the Loop Alarm Time parameter is used.

The value of 'V' is dependent upon input type. For temperature inputs, $V = 2^{\circ}\text{C}$ or 3°F . For linear inputs, $V = 10$ least significant display units.

Correct operation of the loop alarm depends upon reasonably accurate PID tuning. The loop alarm is automatically disabled during manual control mode and during execution of the Pre-Tune mode. Upon exit from manual mode or after completion of the Pre-Tune routine, the loop alarm is automatically re-enabled.

Also refer to Manual Mode, On-Off Control, Pre-Tune, and Process Variable.

Low Calibration Point

This parameter is used to define the low calibration point when the two point calibration method is used to calibrate the controller.

Also refer to Two Point Calibration, Low Offset.

Low Offset

This parameter is used to define the low point offset value when the two point calibration method is used to calibrate the controller. This value is applied to the low calibration point.

Also refer to Two Point Calibration, Low Calibration Point.

Milliamp DC (mADC)

It is used in reference to the dc milliamp input ranges. Typically, these will be 0 to 20mA or 4 to 20mA.

Manual Mode

If $P\%Ct = On$ selected then manual mode is selected. Switching between automatic and manual modes is achieved using bumpless transfer. Please refer to section User Mode.

Mode operates as follows:

The upper display shows the current process value, and the lower display shows the output power in the form - P_{xxx} (where xxx is equal to the percentage output power). This value may be adjusted using the \blacktriangle or \blacktriangledown keys to increase/decrease the power output. The value can be varied between 0% to 100% for controllers using Heat control only, and -100% to +100% for controllers using Heat and Cool control (e.g. full heat power to full cool power).

Manual Mode should be used with care because the power output level is set by the operator, therefore the PID algorithm is no longer in control of the process. The operator MUST maintain the process as the desired level manually.

Manual power is not limited by the Heat and Cool Power Output Limit parameters.

Also refer to Bumpless Transfer, Manual Mode Enable, PID, and Heat Output Power Limit.

Master & Slave

The terms master & slave are used to describe the controllers in applications where one instrument controls the Setpoint of another. The master controller can transmit the Setpoint to the slave using an analogue DC linear signal or RS485. The slave controller must have a matching a remote Setpoint input. Some Profile Controllers can transmit their Setpoint via serial communications serial communications. For this method, the Profiler must be able to act as a communications master device and the slave must have a compatible communications option fitted. This controller can only be configured as a comms slave device, not a Master.

Also refer to Serial Communications and Setpoint

Offset / Single Point Calibration

Offset is used to modify the measured process variable value and is adjustable in the range \pm input span. Use this parameter to compensate for errors in the displayed process variable. Positive values are added to the process variable reading, negative values are subtracted.

This parameter is in effect, a calibration adjustment; it MUST be used with care. Injudicious use could lead to the displayed value bearing no meaningful relationship to the actual process variable therefore resulting in a dangerous condition. There is no front panel indication of when this parameter is in use.

Also refer to Input Span, Process Variable and Tare.



On-Off Control

When operating in On-Off control, the output(s) will turn on or off as the process variable crosses the Setpoint in a manner similar to a central heating thermostat. Some oscillation of the process variable is inevitable when using On-Off control.

On-Off control can be implemented by setting the corresponding proportional band(s) to **On.Off**. On-Off operation can be assigned to the Heat output alone (Cool output not present), Heat and Cool outputs or Cool output only (with the Heat Output set for time proportional).

Also refer to Differential, PID, Process Variable, Heat Proportional Band, Cool Proportional Band, Setpoint and Time Proportioning Control.

On-Off Differential (Hysteresis)

Refer to *Differential*.

PID Control

Proportional Integral and Derivative control maintains accurate and stable levels in a process (e.g. temperature control). It avoids the oscillation characteristic of On-Off control by continuously adjusting the output to keep the process variable stable at the desired Setpoint.

Also refer to Control Type, Automatic Reset, Controller, Manual Mode, On-Off Control, PI Control, Heat Proportional Band, Process Variable, Rate, Cool Proportional Band, Setpoint and Tuning

Overlap/Deadband

Defines the portion of the Heat and Cool proportional bands over which both outputs are active (Overlap), or neither is active (Deadband). It is adjustable in the range -20% to +20% of the two proportional bands added together. Positive + values = Overlap, Negative - values = Deadband.

This parameter is not applicable if the Heat output is set for On-Off control or if there is no Cool Output. If the Cool Output is set for On-Off, this parameter has the effect of moving the Differential band of the Cool Output to create the overlap or deadband. When Overlap/Deadband = 0, the "OFF" edge of the Cool Output Differential band coincides with the point at which the Heat Output = 0%.

Also refer to *Differential, On-Off Control, Heat Proportional Band and Cool Proportional Band*.

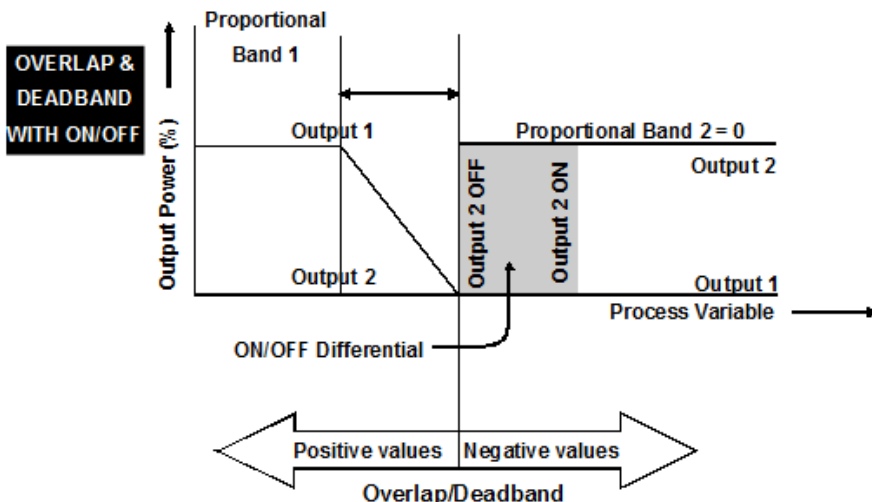
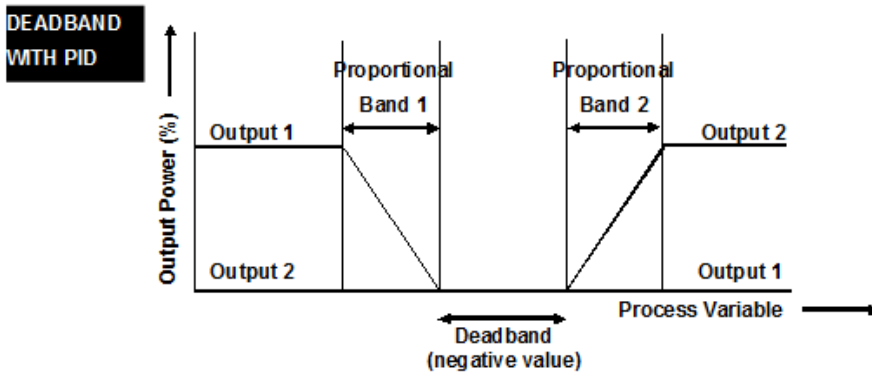
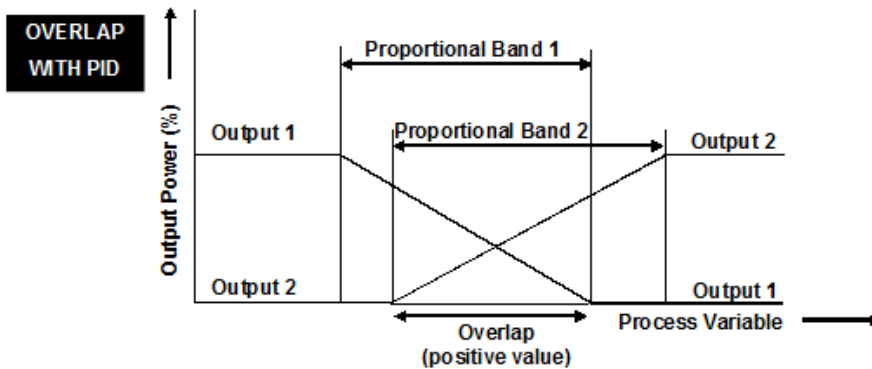

Pre-Tune

As parameters in the tuning process are directly related to the scaled input range, it is important to set **ScUL** and **ScLL** correctly, for your process, before running the tuning. Otherwise you may get the **tEr I** tuning error.

The Pre-Tune facility artificially disturbs the start-up pattern so that a first approximation of the PID values can be made prior to the setpoint being reached. Starting with the load cool, tuning occurs during warm-up preventing overshoot.

During Pre-Tune, the controller outputs full Heat Power until the process value has moved approximately halfway to the Setpoint. At that point, power is removed (or outputs full Cool Power), thereby introducing an oscillation. Once the oscillation peak has passed, the Pre-Tune algorithm calculates an approximation of the optimum PID tuning terms proportional band(s), automatic reset and rate.

When Pre-Tune is completed, the PID control output power is applied using the calculated values. Pre-Tune limits the possibility of Setpoint overshoot when the controller is new or the

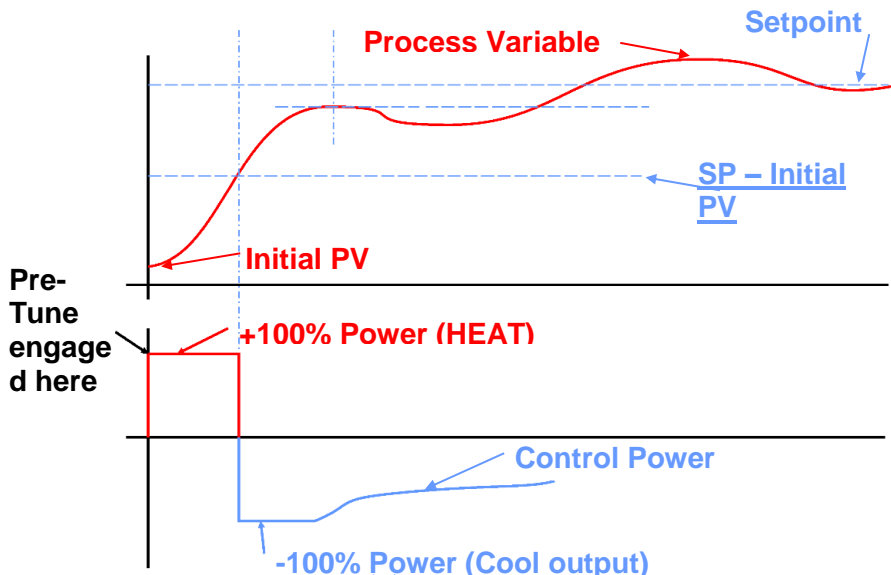

application has been changed. It will automatically disengage once complete. Ideally the Tune program should be used when the load temperature is at or near ambient. Care should be taken to ensure that any overshoot is safe for the process and if necessary tune at a lower setpoint.

Pre-Tune will not engage if either Heat or Cool outputs on a controller are set for On-Off control, the controller is set to Manual, during Setpoint ramping, or if the process variable is less than 5% of the input span from the Setpoint.

Also refer to *Automatic Reset, Control Type, On-Off Control, Input Span, PID, Heat Proportional Band, Process Variable, Rate, Cool Proportional Band, Setpoint, Setpoint Ramping and Tuning.*

Process High Alarm Value

This parameter is applicable only when an Alarm is selected to be a Process High alarm. It defines the process variable value above which an Alarm will be active. Its value may be adjusted between Scale Range Upper Limit and Scale Range Lower Limit.

Also refer to Alarm Operation, Process Variable, Scale Range Lower Limit and Scale Range Upper Limit.

Process Low Alarm Value

This parameter is applicable only when an Alarm is selected to be a Process low alarm. It defines the process variable value below which an Alarm will be active. Its value may be adjusted between Scale Range Upper Limit and Scale Range Lower Limit.

Also refer to Alarm Operation, Process Variable, Scale Range Lower Limit and Scale Range Upper Limit.

Process Variable (PV)

Process Variable is the variable to be measured by the primary input of the instrument. The PV can be any parameter that can be converted into an electronic signal suitable for the input. Common types are Thermocouple or PT100 temperature probes, or pressure, level, flow etc from transducers which convert these parameters into linear DC signals (e.g. 4 to 20mA). Linear signals can be scaled into engineering units using the Scale Range Lower Limit and Scale Range Upper Limit parameters.

Also refer to Input Span, Offset, Scale Range Lower Limit and Scale Range Upper Limit.

Rate (Derivative)

Rate is adjustable in the range 0 seconds (OFF) to 99 minutes 59 seconds. It defines how the control action responds to the rate of change in the process variable. The Rate parameter is not available if Heat control output is set to On-Off.

Also refer to On-Off Control, PID, Process Variable and Tuning.

Reset / Integral

Refer to *Automatic Reset*.

Reverse Acting

Refer to *Direct/Reverse Action of Control Output*



Scale Range Upper Limit

For linear inputs, this parameter is used to scale the process variable into engineering units. It defines the displayed value when the process variable input is at its maximum value. It is adjustable from -1999 to 9999 and can be set to a value less than (but not within 100 units of) the Scale Range Lower Limit, in which case the sense of the input is reversed.

For thermocouple and RTD inputs, this parameter is used to reduce the effective range of the input. All span related functions work from the trimmed input span. The parameter can be adjusted within the limits of the range selected by Configuration Mode parameter **TYPE**. It is adjustable to within 100 degrees of the Scale Range Lower Limit.

Also refer to Input Span, Process Variable and Scale Range Lower Limit.

Scale Range Lower Limit

For linear inputs, this parameter can be used to display the process variable in engineering units. It defines the displayed value when the process variable input is at its minimum value. It is adjustable from -1999 to 9999 and can be set to a value more than (but not within 100 units of) the Scale Range Upper Limit, in which case the sense of the input is reversed.

For thermocouple and RTD inputs, this parameter is used to reduce the effective range of the input. All span related functions, work from the trimmed span. The parameter can be adjusted within the limits of the range selected by parameter **TYPE**. It is adjustable to within 100 degrees of the Scale Range Upper Limit.

Also refer to Input Span, Process Variable and Scale Range Upper Limit.

Serial Communications Option

A feature that allows other devices such as PC's, PLC's or a master controller to read or change (write) an instrument's parameters via an RS485 Serial communications link. Full details can be found in the Serial Communications and sections of this manual.

Input Type	1000	3E8	R/W	Value	Range	1
				0	J Thermocouple	
1	K Thermocouple					
2	PT100					
3	B Thermocouple					
4	C Thermocouple					
5	L Thermocouple					
6	N Thermocouple					
7	R Thermocouple					
8	S Thermocouple					
9	T Thermocouple					
10	0 – 20mA					
11	4 – 20mA					
12	0 – 50mA					
13	10 – 50mA					
14	0 – 5V					
15	1 – 5V					
16	0 – 10V					
17	2 – 10V					
Sensor break status	1072	430	RO	0 = Ok 1 = Sensor break		N/A
Under range status	1073	431	RO	0 = Ok 1 = Under range		N/A
Over range status	1074	432	RO	0 = Ok 1 = Over range		N/A

Also refer to Controller, Indicator, Master & Slave and Limit Controller.

Setpoint

The target value at which a controller will attempt to maintain the process variable by adjusting its power output level. The value of the setpoints can be adjusted between the



Setpoint Upper Limit and Setpoint Lower Limits.

Also refer to Limit Setpoint, Process Variable, Scale Range Lower Limit, Setpoint Lower Limit and Setpoint Upper Limit

Setpoint Upper Limit

The maximum limit allowed for operator Setpoint adjustments. It should be set to keep the Setpoint below a value that might cause damage to the process. The adjustment range is between Scale Range Upper Limit and Scale Range Lower Limit. The value cannot be moved below the current value of the Setpoint.

Also refer to Scale Range Lower Limit, Scale Range Upper Limit, Setpoint and Setpoint Lower Limit.

Setpoint Lower Limit

The minimum limit allowed for operator Setpoint adjustments. It should be set to keep the Setpoint above a value that might cause damage to the process. The adjustment range is between Scale Range Lower Limit and Scale Range Upper Limit. The value cannot be moved above the current value of the Setpoint.

Also refer to Scale Range Lower Limit, Scale Range Upper Limit, Setpoint and Setpoint Upper Limit.

Ramp Rate

The rate at which the actual Setpoint value will move towards its target value, when the Setpoint value is adjusted. With ramping in use, the initial value of the actual Setpoint at power up, or when switching back to automatic mode from manual control, will be equal to the current process variable value. The actual Setpoint will rise/fall at the ramp rate set, until it reaches the target Setpoint value. Setpoint ramping is used to protect the process from sudden changes in the Setpoint, which would result in a rapid rise in the process variable. If the setpoint is changed controller attempts to follow at the predefined ramp rate until the new setpoint is reach.

Also refer to Manual Mode, Setpoint, Setpoint Ramp Enable and Setpoint Select.

Solid State Relay (SSR)

An external device manufactured using two Silicone Controlled Rectifiers, which can be used to replace mechanical relays in most AC power applications. As a solid state device, an SSR does not suffer from contact degradation when switching electrical current. Much faster switching cycle times are also possible, leading to superior control. The instrument's SSR Driver output is a time proportioned 10Vdc pulse, which causes conduction of current to the load when the pulse is on.

Also refer to Cycle Time and Time Proportioning Control.

Solenoid Valve

An electro-mechanical device to control gas or liquid flow. It has just two states, open or closed. A spring holds the valve closed until a current is passed through the solenoid coil forces it open. Standard Process Controllers with Time Proportioned outputs are used to control solenoid valves.

Solenoid valves are often used with high/low flame gas burners. A bypass supplies some gas at all times, but not enough to heat the process more than a nominal amount (low flame). A controller output opens the solenoid valve when the process requires additional heat (high flame).

Also refer to Time Proportioning Control.



Time Proportioning Control

Time proportioning control is accomplished by cycling the output on and off, during the prescribed cycle time, whenever the process variable is within the proportional band. The control algorithm determines the ratio of time (on vs. off) to achieve the level of output power required to correct any error between the process value and Setpoint.

E.g. for a 32 second cycle time, 25% power would result in the output turning on for 8 seconds, then off to 24 seconds. This type of output might be used with electrical contactors, Solid State Relays Time proportioning control can be implemented with Relay or SSR Driver outputs for either primary (Heat) or secondary (Cool) outputs depending on hardware configuration.

Also refer to Cycle Time, PID, Heat Proportional Band, Process Variable, Cool Proportional Band, Setpoint and SSR.

Tuning PID

PID Controllers must be tuned to the process in order for them to attain the optimum level of control. Adjustment is made to the tuning terms either manually, or by utilising the controller's automatic tuning facilities. Tuning is not required if the controller is configured for On-Off Control.

Also refer to Automatic Reset, ON-OFF control, PID, Pre-Tune, Tune at Setpoint, Heat Proportional Band, Rate and Cool Proportional Band.

Tune at Setpoint

As parameters in the tuning process are directly related to the scaled input range, it is important to set **ScUL** and **ScLL** correctly, for your process, before running the tuning.

The Tune at Setpoint will not engage if the Heat or Cool outputs are set for **On.OF** control, the controller is set to Manual or during setpoint ramping.

The controller waits for the process to be in an approximate steady state for 5 minutes and if necessary attempts to further stabilise the process before continuing with the tuning.

At time, **T₀**, the controller makes a pulse of 20% change in the power output. It is reduced if the power value was >20% and increased if the power value was <20%.

When the process value changes by 1% of range, the output is returned to its previous value, **T₁**.

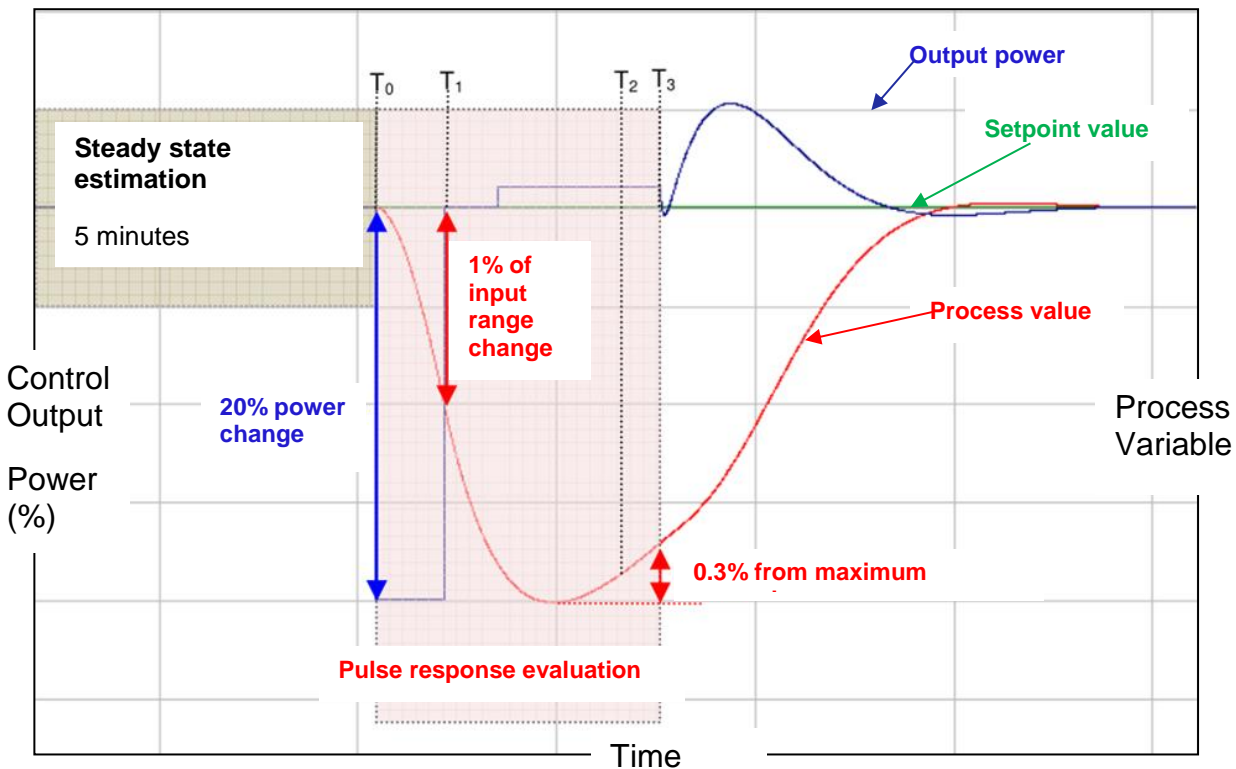

The process will reach a maximum excursion away from the setpoint and then return towards the setpoint. After a 0.3% recovery from maximum excursion, the pulse response characteristics are used to calculate the correct tuning terms.

Also refer to *Automatic Reset, Control Type, On-Off Control, Input Span, PID, Heat Proportional Band, Process Variable (PV), Rate, Cool Proportional Band, Setpoint, Setpoint Ramping and Tuning.*

16 Product Code

MV - xx x x - x x x x - 2 x U 0 xxxx

Format

1/16 DIN, 48 x 48mm **16**
 1/8 DIN, 96 x 48mm **08**

Variant

Standard **0**
 Extrusion **E**

Supply Voltage

110 to 240V AC **M**
 24V AC / DC **L**

Output

Out 1	Out 2	Out 3			
SSR	SSR	None	A	A	0
SSR	Relay	None	A	R	0
Relay	Relay	None	R	R	0
SSR	SSR	Relay	A	A	R
SSR	Relay	Relay	A	R	R
Relay	Relay	Relay	R	R	R

Terminal Cover

blank Not Fitted
 S415 Fitted

Manual Language

- 1 English
- 2 French
- 3 German
- 4 Italian
- 5 Spanish
- 6 Chinese

Option Slot 2

- 0 Not Fitted
- C RS485 Communications

17 West Control Solutions



Austria

Tel.: +43 (0)2236 691-121

Fax: +43 (0)2236 691-102

AT@West-CS.com



Germany

Tel.: +49 (0)561 505-1307

Fax: +49 (0)561 505-1710

DE@West-CS.com



China

Tel: +86 22 2390 0700

Sales: +86 400 666 1802

Fax: +86 22 2390 0710

CN@West-CS.com



United Kingdom

Tel.: +44 (0)1273 606271

Fax: +44 (0)1273 609990

UK@West-CS.com



France

Sales: +33 1 71 84 17 32

Technical: +33 1 71 84 17 31

Fax: +33 1 82 88 27 55

FR@west-cs.com



United States

Tel.: 800 866 6659

Fax: 847 782 5223

NA@West-CS.com