

SHORT MANUAL Rev. 03/2019

Relay C 2PH

from 30A to 40A

Important warnings for safety

	This icon is present in all the operational procedures where the Improper operation may result in serious personal injury or death by Electrical Shock Hazard Symbol (a lightning bolt in a triangle) precedes an electric shock hazard CAUTION or WARNING safety statement.
	Warning or Hazard that needs further explanation than the label on unit can provide. Consult User's Guide for further information.
	Unit is compliant with European Union directives. See Declaration of Conformity for further details on Directives and Standards used for Compliance.
	If available, unit is a Listed device per Underwriters Laboratories. It has been investigated to ANSI/UL® 508 standards for Industrial Control Switches and equivalent to CSA C22.2 #14. For more detail search for File E505847 on www.ul.com
	ESD Sensitive product, use proper grounding and handling techniques when installing or servicing product.
	Do not throw in trash, use proper recycling techniques or consult manufacturer for proper disposal.

Safety notes

- ⚠ **WARNING!** To avoid damage to property and equipment, injury and loss of life, adhere to applicable electrical codes and standard wiring practices when installing and operating this product. Failure to do so could result in damage, injury and death.
- ⚠ **ATTENTION!** Pour éviter d'endommager la propriété et l'équipement, les blessures et la perte de vie, respecter les codes électriques en vigueur et les pratiques de câblage standard au moment de l'installation et de l'utilisation de ce produit. Dans le cas contraire, cela peut entraîner la mort, des blessures graves ou des dommages.
- ⚠ **WARNHINWEIS!** Um Sach- und Personenschäden, Verletzungen und den Verlust von Leben zu vermeiden, halten Sie sich bei der Installation und dem Betrieb dieses Produkts an die geltenden Elektrovorschriften und Standardverfahren für die Verdrahtung. Andernfalls kann es zu Schäden, Verletzungen und Tod führen.
- ⚠ **WARNING!** All service including inspection, installation, wiring, maintenance, troubleshooting, fuse or other user serviceable component replacement must be performed only by properly qualified personnel. Service personnel must read this manual before proceeding with work. While service is being performed unqualified personnel should not work on the unit or be allowed in the immediate vicinity.
- ⚠ **ATTENTION!** Tous les services, y compris l'inspection, l'installation, le câblage, l'entretien, le dépannage, le remplacement de fusibles ou d'autres composants pouvant être réparés par l'utilisateur, doivent être effectués uniquement par un personnel d'entretien qualifié. Le personnel de service doit lire ce manuel avant d'effectuer tout travail. Pendant que l'entretien est exécuté, tout personnel non qualifié ne doit effectuer de travail sur l'appareil ni se trouver à proximité.
- ⚠ **WARNHINWEIS!** Alle Wartungsarbeiten, einschließlich Inspektion, Installation, Verdrahtung, Wartung, Fehlersuche, Sicherung oder anderer vom Benutzer zu wartenden Komponenten, dürfen nur von qualifiziertem Fachpersonal durchgeführt werden.
- Das Wartungspersonal muss dieses Handbuch lesen, bevor es mit der Arbeit fortfährt. Während der Wartung darf nicht qualifiziertes Personal nicht an diesem Gerät oder in unmittelbarer Nähe arbeiten.
- ⚠ **WARNING!** When in use the power controller is connected to dangerous voltages. Do not remove the protective covers without first disconnecting and preventing power from being restored while servicing the unit.
- ⚠ **ATTENTION!** Au moment de l'utilisation, le régulateur de puissance est connecté à des tensions dangereuses. Ne retirer aucun couvercle de protection sans d'abord débrancher l'appareil et ainsi empêcher l'alimentation d'être rétablie pendant l'entretien.
- ⚠ **WARNHINWEIS!** Während dem Betrieb ist der Thyristor Leistungssteller an gefährlichen Spannungen angeschlossen. Entfernen Sie die Schutzabdeckungen nicht, ohne vorher die Spannungsversorgung unterbrochen zu haben und die Anlage gegen Wiederherstellung der Stromversorgung zu sichern, während Sie das Gerät warten.
- ⚠ **WARNING!** Do not use in aerospace or nuclear applications.
- ⚠ **ATTENTION!** Ne pas utiliser pour les applications aérospatiales ou nucléaires.
- ⚠ **WARNHINWEIS!** Nicht in Luft-, Raumfahrt- oder Nuklearanwendungen verwenden.
- ⚠ **WARNING!** Electric Shock Hazard: when the power controller has been energized, after shutting off the power, wait at least one minute for internal capacitors to discharge before commencing work that brings you in to contact with power connections or internal components.
- ⚠ **ATTENTION!** Risque de décharges électriques: lorsque le régulateur de puissance est mis sous tension, après avoir été éteint, attendre au moins une minute pour que les condensateurs internes se déchargent avant de commencer tout travail incluant le contact avec les connexions électriques ou les composants internes.
- ⚠ **WARNHINWEIS!** Stromschlaggefahr: Warten Sie nach dem Ausschalten des Leistungsstellers mindestens eine Minute, bis sich die internen Kondensatoren entladen haben, bevor Sie mit Arbeiten beginnen, die Sie mit den elektrischen Anschlüssen oder internen Komponenten in Kontakt kommen.
- ⚠ **WARNING!** The installation must be protected by electromagnetic circuit breakers or by fuses. The semiconductor fuses located inside the power controller are classified for UL as supplementary protection for semiconductor devices. They are not approved for branch circuit protection.
- ⚠ **ATTENTION!** L'installation doit être protégée par des disjoncteurs électromagnétiques ou des fusibles. Les fusibles pour semi-conducteurs situés à l'intérieur du régulateur de puissance sont classés UL comme protection supplémentaire pour les dispositifs pour semi-conducteurs. Ils ne sont pas approuvés pour la protection des circuits de dérivation.
- ⚠ **WARNHINWEIS!** Die Installation muss durch elektromagnetische Schutzschalter oder Sicherungen abgesichert sein. Die Halbleitersicherungen, die sich innerhalb des Leistungsstellers befinden, sind als zusätzlicher Schutz für Halbleitervorrichtungen für UL klassifiziert. Sie sind nicht für den Nebenstromkreis-schutz (branch circuit protection) zugelassen.
- ⚠ **CAUTION:** Install an appropriately sized RC filter across contactor coils, relays and other inductive loads.
- ⚠ **AVERTISSEMENT:** Installer un filtre RC de dimensions appropriées sur les bobines du contacteur, les relais et autres charges par induction.
- ⚠ **VORSICHT:** Installieren Sie einen geeigneten RC-Filter an den Schützspulen, Relais und anderen induktiven Lasten.
- ⚠ **CAUTION:** The thyristor units here described have been designed for use with sinusoidal networks with nominal frequency 50-60 Hz. Any application with NON-SINUSOIDAL, distorted or disturbed networks could compromise the correct operation of the unit.
- ⚠ **AVERTISSEMENT:** Les unités de thyristors décrites ici ont été conçues pour être utilisées avec des réseaux sinusoïdaux d'une fréquence nominale de 50 à 60 Hz. Toute application utilisant des réseaux NON SINUSOÏDAUX, déformés ou perturbés peut compromettre le bon fonctionnement de l'appareil.
- ⚠ **VORSICHT:** ACHTUNG: Die hier beschriebenen Thyristor-Einheiten sind für den Einsatz in Sinusnetzen mit einer Nennfrequenz von 50 bis 60 Hz ausgelegt. Jede Anwendung mit NICHT SINUSFÖRMIGER Wellenform, verzerrten oder gestörten Netzwerken kann den korrekten Betrieb des Geräts beeinträchtigen.
- ⚠ **NOTE:** The nominal current is specified for ambient temperatures at or below 40° C. Ensure the application design allows for adequate cooling of each power controller. The power controller must be mounted vertically. The cooling design must prevent air heated by one power controller from causing power controllers mounted above to exceed the ambient operating temperature limit. When power controllers are mounted

side by side allow a minimum spacing of 15mm between them.

⚠ **REMARQUE:** Le courant nominal est précisé pour des températures ambiantes égales ou inférieures à 40°C. S'assurer que la conception de l'application permette le refroidissement adéquat de chaque régulateur de puissance. Le régulateur de puissance doit être monté verticalement. La conception de refroidissement doit empêcher l'air chauffé par le régulateur de puissance de dépasser la limite de température de fonctionnement ambiante de la part des régulateurs de puissance montés au-dessus. Lorsque les régulateurs de puissance sont montés côte à côte, il faut conserver un espacement minimal de 15 mm entre les deux.

⚠ **HINWEIS!** Der Nominalstrom ist für Umgebungstemperaturen von maximal 40 °C spezifiziert. Stellen Sie sicher, dass in Ihrer Anwendung eine ausreichende Kühlung für jeden Leistungssteller ermöglicht. Der Leistungssteller muss vertikal montiert werden. Das Kühlkonzept muss verhindern, dass die von einem Leistungssteller erwärmte Luft dazu führt, dass die darüber montierten Leistungssteller die zulässige Umgebungstemperatur überschreiten. Wenn Leistungssteller nebeneinander montiert werden, muss ein Mindestabstand von 15 mm eingehalten werden.

⚠ **NOTE:** Use only copper cables and wires rated for use at 90°C or greater.

⚠ **REMARQUE:** N'utiliser que des cables et des fils en cuivre pour l'utilisation à 90°C ou plus.

⚠ **HINWEIS!** Verwenden Sie nur Kupferkabel und Leitungen, die für den Gebrauch bei 90 °C oder höher ausgelegt sind.

1. Overview

Integrated semiconductor fusing, current transformer and user interface

- Saves installation time and eases setup and commissioning
- Delivers a user-friendly, intuitive interface

Industry-leading design and serviceability

- Offers a robust SCR design to meet a rugged industrial environment's high quality and reliability needs
- Provides quick and easy access to maintain and service fuses and individual legs in minimal time
- Enables fast troubleshooting by providing helpful thermal system diagnostics

Comprehensive power controller range

- Provides wide range of options from simple single phase to complex three-phase loads to 690V

100KA short circuit current rating (SCCR) (Not reviewed by UL®)

- Enables greater protection in the event of a short circuit

c-UL® 508 Listed

- Shortens project schedules, agency testing and expenses

Control modes: contactor, voltage, current or power

- Satisfies a wide range of demanding thermal applications

Load firing modes: zero-cross, burst fire

- Handles a wide range of load types including nichrome, medium and long waveform infrared lamps, moly, transformers, silicon carbide, UV lamps and tungsten
- Protects and extends the life of connected loads

Wide range of communication protocols

- Enable factory and process automation with connectivity to process and equipment data via Modbus® RTU, Modbus® TCP, Wi-Fi, Profibus, Profinet, USB device (configuration and data file transfers)

Open heater and shorted SCR indication

- Minimizes production downtime with easy to understand, intelligent, troubleshooting diagnostics

Integrated USB and user interface for configuration

- Easily and safely program configuration settings as the user interface can be powered through USB connection
- Eliminates need to work in a high voltage hazard environment. High voltage to the power controller and system panel can be shut off and locked out for safety while configuring controller.

2. Software Configurator

Thyristor configurator software is free and is possible download it from our site: <https://www.west-cs.co.uk/resources-uk/software-uk/pma-products-software/>

To connect the unit at the PC, it's necessary to use the micro USB 2.0 Modbus RTU cable. USB connection need a driver to work properly, you can find it from our site. However the configuration software installer will install as default the correct driver.



3. Quick Start • READ CAREFULLY BEFORE START

- ⚠ **Attention:** this procedure must be carried out by skilled people only.
- If your Relay C code is in line with what you really need, then the main configuration is already done by Producer and you just need to do the following steps:
 1. Verify Relay C current sizing. Be sure that:
 - the load current is equal or less than the nominal one of Relay C
 - the main voltage is equal or less than the nominal voltage of Relay C
 2. Verify the Installation
 3. Verify the Wiring:
 - all auxiliary connections must be done in line with wirings on this manual
 - verify that there isn't a short circuit on the load
 4. Supply the Unit
 5. Go in the Operator menu
 - Set the parameters Operative Load Voltage and Nominal Current of the load using the frontal keypad or Thyristor configurator software.
 - The Unit is ready to work

The auxiliary voltage supply of the Relay C unit must be synchronized with load voltage power supply. If the Auxiliary Voltage (written on the identification label) is different from Supply Voltage (to the load), use an external transformer.

IMPORTANT! Starting Strategy (Enable):

- 1: Feed the unit with L1-L2-L3 power voltage supply
- 2: Feed the auxiliary supply
- 3: Close the Enable contact to start with the regulation

If your Relay C code is NOT in line with what you really need, use the enclosed configurator software tool to set-up the unit. Install the software on your PC, select Relay C and click on test unit changing what you need.

4. Identification of the unit

⚠ **Caution:** Before to install, make sure that the Thyristor unit have not damages. If the product has a fault, please contact the dealer from which you purchased the product.

The identification's label give all the information regarding the factory settings of the Thyristor unit, this label is on the unit. Verify that the product is the same thing as ordered.

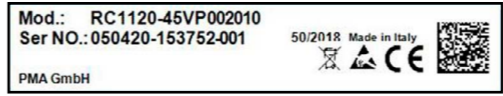

5. Technical Specifications

5.1. General features

Cover and Socket material: PolymericV2

Mounting: DIN bar (thickness type 1mm Max)

Utilization Category: AC-51 AC-55b

IP Code: 20

Method of Connecting: Load in Delta, load in Star

Auxiliary voltage, power supply Control Circuit: TR1 range 1 = 90:135V (8 VA Max)
TR1 range 2 = 180:265V (8 VA Max)
TR2 range 1 = 180:265V (8 VA Max)
TR2 range 2 = 342:528V (8 VA Max)
TR3 range 1 = 238:330V (8 VA Max)
TR3 range 2 = 540:759V (8 VA Max)

Relay output for Heater Break Alarm: (only with HB option) 0.5A a 125VAC

5.2. Input features

Digital Input: 4 + 30Vdc 5mA Max (ON ≥ 4Vdc OFF < 1Vdc) 5Hz max

Volt Analogic input: 0 + 10Vdc impedance 15 K ohm

Current Analogic input: 0 + 20mA impedance 100 ohm
4 + 20mA impedance 100 ohm

POT: 10 K ohm min.

Logic input SSR (Fast Enable): 4 + 30Vdc 5mA Max (ON >4Vdc OFF <1Vdc) 3HZ Max duty cycle min. 100 ms

5.3. Output features (power device)

Nominal current in continuous service: See order code

Max peak current (10ms): 360A for unit type 030
540A for unit type 035
700A for unit type 040

Nominal Voltage range Ue: 24-600V

Repetitive peak reverse voltage Uimp: 1200V (480V) 1600V (600V)

Latching current: 250mA

Leakage current: 15mA eff

FUSE I²T value suggested at 500Vac tp=10msec: 525 A²s for unit type 030
1260 A²s for unit type 035
1260 A²s for unit type 040

Frequency range: 47-70Hz

Power loss (I=Inom): 76W for unit type 030
88W for unit type 035
100W for unit type 040

Isolation Voltage Ui: 2500Vac

5.4. Environmental installation conditions

Ambient temperature 0-40°C (32-104°F) at nominal current. Over 40°C-104°F use the derating curve.

Storage temperature -25°C to 70°C -13°F to 158°F

Installation place Don't install at direct sun light, where there are conductive dust, corrosive gas, vibration or water and also in salty environmental.

Altitude Up to 1000 meter over sea level. For higher altitude reduce the nominal current of 2% for each 100m over 1000m

Humidity From 5 to 95% without condense and ice

Pollution Level Up to 2nd Level ref. IEC 60947-1 6.1.3.2

5.5. Derating Curve

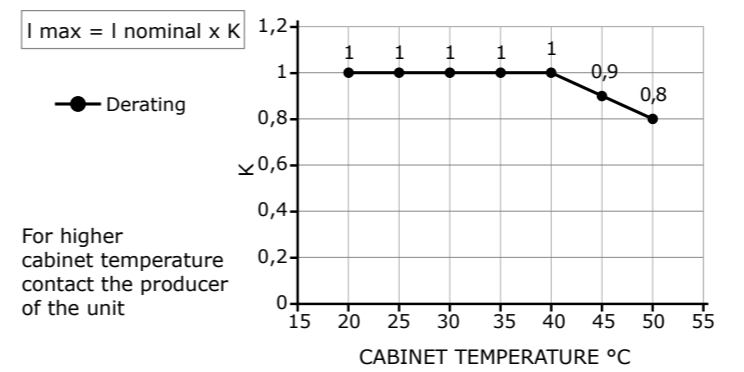

For higher cabinet temperature contact the producer of the unit

6. Installation

Before to install, make sure that the Thyristor unit have not damages. If the product has a fault, please contact the dealer from which you purchased the product. Verify that the product is the same thing as ordered. The Thyristor unit must be always mounted in vertical position to improve air cooling on heat-sink. Maintain the minimum distances (*) in vertical and in horizontal as represented, this area must be free from obstacle (wire, copper bar, plastic channel). When more unit has mounted inside the cabinet maintain the air circulation like represented in figure without obstacle for the air flow. Is necessary to install a fan to have better air circulation as calculated previously. The V Air flow must be equal or more than the value calculated. If the cabinet fan mounted by the customer have an air flow lower than the correct value the warranty will decay.

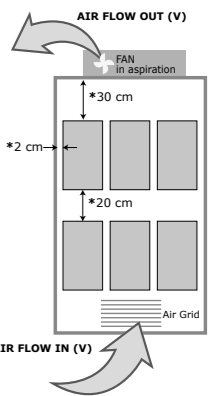

6.1 Dimensions and weight

Size: SR10 (2PH)

W (mm): 108

H (mm): 121

D (mm): 185

Weight (Kg): 1,76

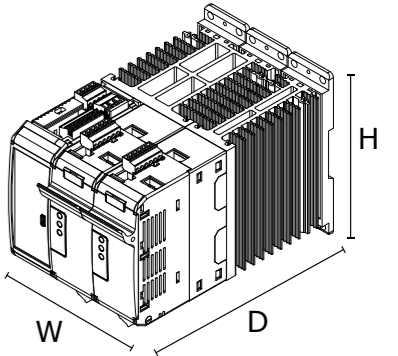

6.2 Fixing holes

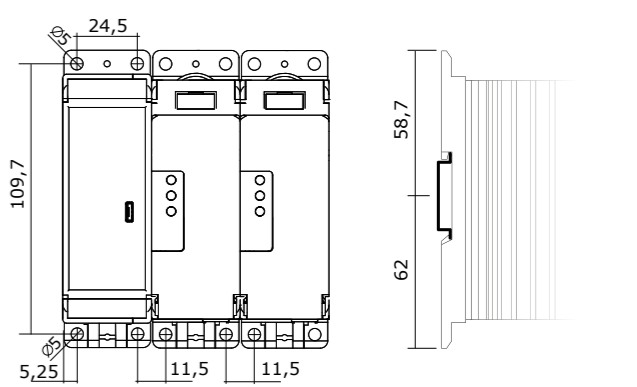

7. Wiring instructions

The Thyristor unit could be susceptible to interferences lost by near equipments or by the power supply, for this reason in accord to the fundamental practices rules is opportune take some precautions:

- The coil contactor, the relays and other inductive loads must be equipped with oportune RC filter.
- Use shielded bipolar cables for all the input and output signals.
- The signal cables must not be near and parallel to the power cables.
- Local regulations regarding electrical installation should be rigidly observed. Use 90°C copper (CU) conductor only, wire ranges (AWG), wire terminal type (ZMVV), terminal tightening torque in the table below.

Power cable torque (suggested)

Type	Connector Type	Torque Lb-in (N-m)	Wire Range mm ² (AWG)	MAX Current Terminals	Wire Terminals UL Listed (ZMVV)
030 035 040	Screw M5	26.6 (3.0)	1.5-10 (16-8)	40A	Rigid / Flexible Spade Terminal

Cable dimensions of the Command Terminals 0.5 mm² (AWG 18)
Temperature rating: 90°C or greater

Cable dimensions of the Earth (suggested) 6 mm² (AWG 10)
Temperature rating: 75°C or greater

⚠ **Warning:** Before connecting or disconnecting the unit check that power and control cables are isolated from voltage sources.

Terminal	Description
L1	Line Input Phase 1
T1	Load Output Phase 1
L3	Line Input Phase 2
T3	Load Output Phase 2

7.1. Command Terminals

Warning: Before connecting or disconnecting the unit check that power and control cables are isolated from voltage sources.

7.1.1. Terminal block M2

Terminal	Description
1	GND
2	COM 1 - Common Digital Input
3	DI 2 - Enable Digital Input
4	DI 1 - Configurable Input
5	+ Analog Input1 (0-10Vdc/4-20mA Analog Setpoint)
6	- Analog Input1 (0-10Vdc/4-20mA Analog Setpoint)
7	Output +10Vdc stabilized 1 mA MAX
8	Slave Output - (factory connection)
9	Slave Output + (factory connection)

7.1.2. Terminal block M1

Terminal	Description
10	GND
11	TA1 Input (factory connection)
12	TA1 or TA2 input (factory connection)
13	TA3 input (factory connection)
14	C - Common contact alarm relay output
15	NO - Normally Open contact alarm relay output (Thermal or SC/HB/CL)
16	NC - Normally Close contact alarm relay output (Thermal or SC/HB/CL)

7.1.3. Terminal block M3

Terminal	Description
A+	RS485 A+
B-	RS485 B-

7.1.4 Terminal block M4

Terminal	Description
L1	Aux - Voltage Supply for electronic boards and synchronization (See order code for the Value)
-	Not Connected
L2/N	Aux - Voltage Supply for electronic boards and synchronization (See order code for the Value)

7.1.5 Terminal block M6

Terminal	Description
17	Auxiliary +24Vdc 500mA Input backup power supply for communication
18	- Analog Input2 (0-10Vdc/4-20mA Analog Setpoint) - 0 Volt
19	+ Analog Input2 (0-10Vdc/4-20mA Analog Setpoint)
20	Retransmission Output 0-10Vdc 4-20mA

7.1.6 Terminal block M5 (only with Second serial485 optional)

Terminal	Description
A+	RS485 A+
B-	RS485 B-

7.2. Schematic

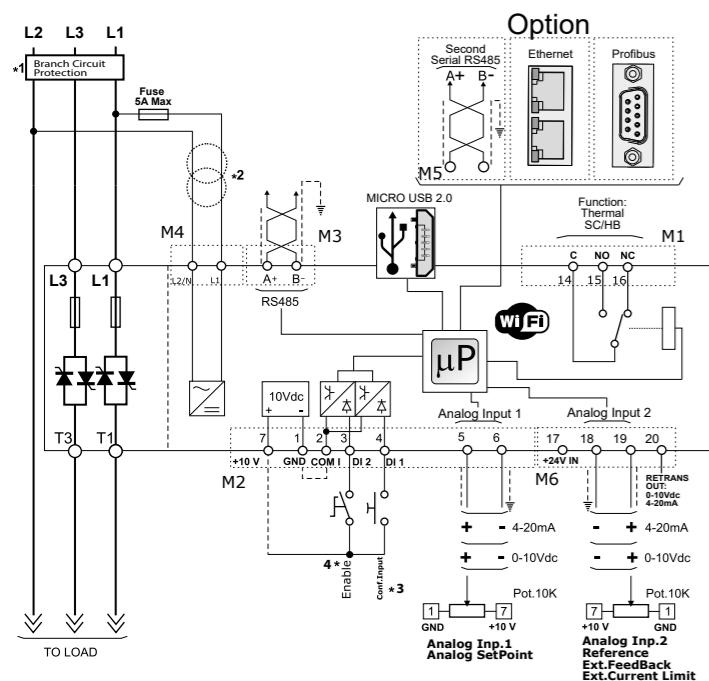

NOTE:
 *1 The user installation must be protecting by electromagnetic circuit breaker or by fuse isolator. The Fuse must be branch circuit protection. For UL any listed UL branch circuit fuse would be acceptable as an external fuse, following national electric code guide for resistive heating of 125% load current rating to protect external wires.
 *2 The auxiliary voltage supply of the Relay C unit must be synchronized with load voltage power supply. If the Auxiliary Voltage (written on the identification label) is different from Supply Voltage (to the load), use an external transformer as designated.
 *3 For SSR input connection follow next schematic.

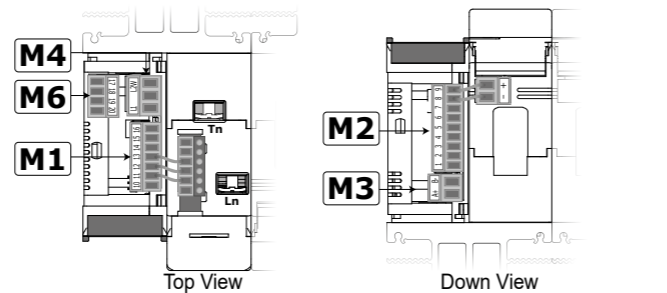

7.3. SSR Control Input schematic

For SSR input use follow the schematic on the side and configure Digital Input 1 as Fast Enable.

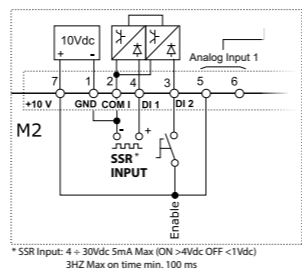

8. Control Panel

The Control Panel is placed on the front of the thyristor unit, on his display you can visualize the alarms, the input and output signals and all the configuration parameters.

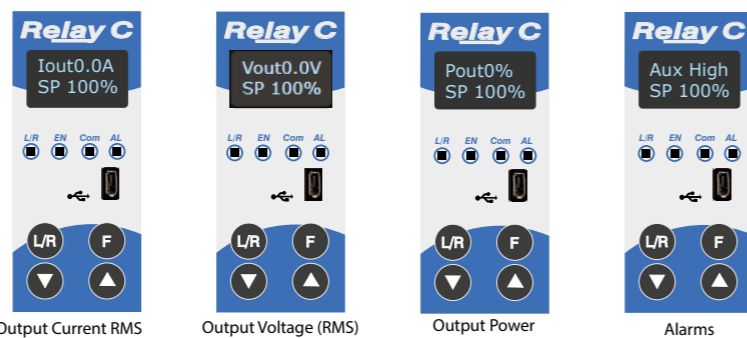

On the home page the keys are used as follows:

Press...	to...
F	Function: Scroll through the parameters on the home page
L/R	Local/Remote: Switch between local and remote set point for power demand
▲	Up: Increment power demand set point when set to local
▼	Down: Decrement power demand set point when set to local
F + L/R	Press and hold for about two seconds to access the menus

To view the status parameters:
 Press Function **F** once to advance from one parameter to the next
 To set the set point locally:
 Press Local/Remote **L/R** (Note: indicator 1 flashes steadily when set point is set locally)
 Use Down **▼** and/or Up **▲** to set the local set point.

8.1. Menu navigation

The menus are accessible using the control panel keypad and display.

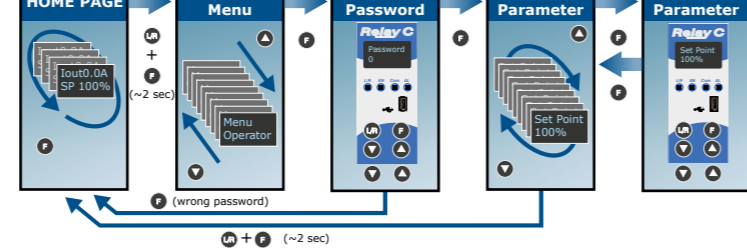

To access a menu and edit a setting:
 1. Press and hold Local/Remote and Function together **L/R** + **F** until the upper display flashes Menu.
 2. Press Up **▲** to choose the menu. (Press down **▼** if you overshoot the menu you want).
 3. Press function **F** to advance to the password prompt.
 4. Use up **▲** and/or down **▼** to set the password (see the table).
 5. Press function **F** to enter the password and advance to the first parameter of the menu.
 6. Press Up **▲** to advance to the next parameter and repeat to reach the desired parameter.
 7. Press function **F** to start editing the parameter. The parameter name flashes in the upper display.
 8. Use Up **▲** and/or down **▼** to edit the parameter setting.
 9. Press function **F** to enter the new setting. The parameter name stops flashing.
 10. Press and hold local/remote and function together **L/R** + **F** for about two seconds to exit the menus.

Menu	Password	Parameter used to...
Operator	0	View measured values and basic settings including current, voltage and set point
Setup	2	Configure the power controller for the load
Adv Setup	10	Configure the operation and performance of the power controller in the application
Hardware	5	Configure the functions of the analog and digital inputs and outputs, and the re-transmission parameters
Comm	3	Configure field bus communicating parameters
Monitoring	0	View measured and calculated values and other read-only parameters

8.2. Control Panel Led

The four indicators on the control panel show the general state of the power controller.

Indicator	State	Meaning
1 Local/Remote	Flashing	Power output set locally or via communications
1 Local/Remote	Off	Power output set remotely (via analog input)
2 Enable	On	Output enabled
2 Enable	Off	Output disabled
3 Communications	Flashing	Active communications
4 Alarm	On	Active alarm
4 Alarm	Off	No alarm

9. Supply the electronic board

The Relay C thyristor unit, to work, requires a voltage supply for the electronic boards. The Max consumption is 10VA. The voltage supply for the electronic boards is configured in line with customer requirements that are defined in the Order Code. The Order Code is written on the identification label.

Warning: Before connecting or disconnecting the unit check that power and control cables are isolated from voltage sources.

Terminal M4	Description
1	Voltage Supply for Electronic Boards (Auxiliary Voltage)
2	Not Used
3	Voltage Supply for Electronic Boards (Auxiliary Voltage)

To change auxiliary supply voltage send the correct link-jumper on Relay C board. The type of mounted transformer depends of the chosen Voltage in the order code.

Transformer Type	Link-Jumper JP1+JP2	Link-Jumper JP3
TR-605 120V-TR1	90:135V	180:25V
TR-605 230V-TR2	180:265V	342:528V
TR-605 300V-TR3	238:330V	540:759V

If the Auxiliary Voltage (written on the identification label) is different from Supply Voltage (to the load), use an external transformer with primary equal to load voltage and secondary equal to the Auxiliary Voltage.

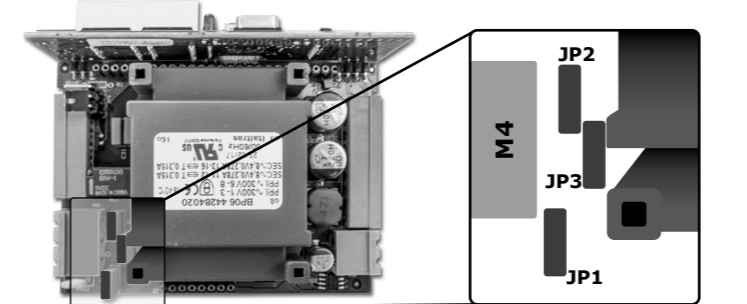

secondary equal to the Auxiliary Voltage.

Attention! never link all the jumpers JP1+JP2+JP3 at the same time or jp3 + any other jumper, JP3 must be always alone, follow only the configuration shown.

10. RS485 Serial port

M3 Terminal	Description
A+	RS485 A+
B-	RS485 B-

The serial communication port RS485 is available on the Command Terminal. On this port may be done a network up to 127 Relay C.

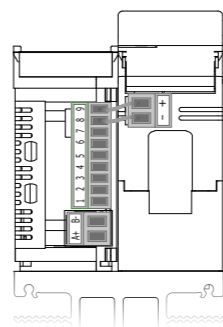

11. Fieldbus communication option

Other serial communication port are available as option, see Communication Manual for details.

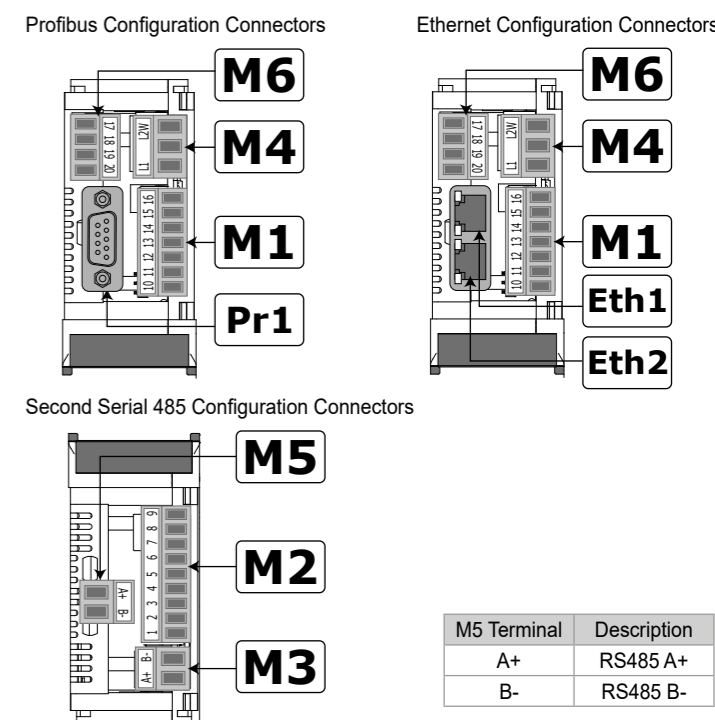

M5 Terminal	Description
A+	RS485 A+
B-	RS485 B-

12. Internal Fuse

The thyristor unit have internal fuse extrarapid at low I²t for the thyristor protection against the short-circuits. The Fuses must have I²t 20% less than thyristor's I²t. The warranty of thyristor is null if no proper fuses are used.

Type	Fuse Code Spare Part	Current (ARMS)	I ² T at 500Vac* (A ² sec.)	Vac	Max Power Lost (W)
030	FU1451/40A	40	525	660	8
035	FU1451/50A	50	1260	660	9
040	FU1451/50A	50	1260	660	9

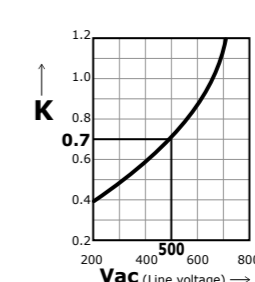

*I²T are multiplied for K value in function of Vac at 500V K is equal to 0,7 (1800 X 0,7 = 1260). At 660Vac K is equal to 1.
 Caution: High speed fuses are used only for the thyristor protection and can not be used to protect the installation.
 Caution: The warranty of thyristor is null if no proper fuses are used. See tab.
 Warning: When it is supply, the Thyristor unit is subject to dangerous voltage, don't open the Fuse-holder module and don't touch the electric equipments.

12.1. Fuses Replacement

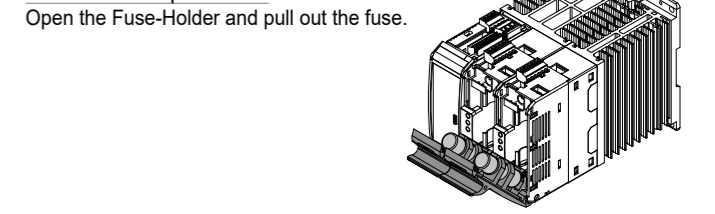

DOWNLOAD THE FULL MANUAL FROM:
www.west-cs.co.uk

Contact

UK
 Email: enquiries@west-cs.com
 Website: www.west-cs.co.uk
 Telephone: +44 (0)1273 606271

Germany
 Email: de@west-cs.com
 Website: www.west-cs.de
 Telephone: +49 561 505 1307

France
 Email: fr@west-cs.com
 Website: www.west-cs.fr
 Telephone: +33 171 84 1732

