

Relay S-2PH from 30A to 40A Power Controller

General Description

- Relay S has been specifically designed to save space and labour
- These simple units can be connected with Relay PC to manage multizone system this minimize your energy cost by controlling synchronization and power limit on each zone
- Integrated fuse + fuse holder is necessary to have a complete power control zone including current transformer and optional circuit board
- Flat Cable Wiring System (option) to connect in plug in mode many Relay S when HB alarm or analogue input are used
- Input signal: SSR, Analogue as an option
- Zero Crossing, Burst Firing available at 4, 8 or 16 Cycles at 50% of Power demand
- Electronic fully isolated from power with constant current drain on input.
- Heater Break alarm option to diagnose partial or total load failure and Thyristor Short circuit
- Fuse and Fuse holder available as an option
- Current transformer integrated (with Heater Break option)
- Special design for Heat sink with very high dissipation value
- CE, cUL
- DIN RAIL side by side mounting
- IP20 Protection



Technical Specification

Voltage power supply	24V minimum up to 480V, 600V On request		
Voltage Frequency	50 or 60 Hz no setting needed from 47 to 70 Hz		
Nominal Current	30A, 35A, 40A		
Input Signal	SSR for Relay S, No Fuse,	5:30Vdc	18mA Max (On ≥ 5Vdc Off ≤ 4Vdc);
	SSR for Relay S, Fuse + Fuse Holder	7:30Vdc	18mA Max (On ≥ 7Vdc Off ≤ 6Vdc);
	SSR for Relay S, Fuse + Fuse Holder, + HB	4:30Vdc	6mA Max (On ≥ 4Vdc Off ≤ 1Vdc);
	Voltage input	0:10Vdc	impedance 15 K ohm;
	Current input	0:20/4:20mA	impedance 100 Ohm;
Firing	Zero Crossing, Burst Firing with analog input signal only		
Auxiliary Voltage Supply	12:24V dc/ac (max 70 mA) required only with HB Alarm or Analogue Input Option		
Heather Break Alarm	Microprocessor based with automatic setting Digital Input, Relay Output 0.5A at 110V		
Mounting	DIN RAIL or panel mounting		
Operating Temperature	40 °C without derating. Over this temperature see below derating curve		
Storage temperature	-25 °C to 70 °C Max		
Altitude	Over 1000 m of altitude reduce the nominal current of 2% for each 100m		
Humidity	From 5 to 95% without condense and ice		

Option's features and special details

Heater Break Alarm (HB)

ON FRONT CABINET



FEW SECOND TO SET AND CALIBRATE THE UNITS

- Microprocessor based circuit
- Capacity to diagnose the failure of one Resistance over five in parallel
- Load failure alarm with LED indication on front unit
- Thyristor short circuit alarm with LED indication on front unit
- Alarm output with free voltage relay contact
- Alarm reset function and possibility to auto reset if the alarm disappear
- Built in Current transformer when heather Break option has been selected
- Self Setting via external command or push button on front unit
- Commom setting command can be given to many units and in a matter of second, the tuning is done, also by a non expert operator

How to add power load management and features to your simple units

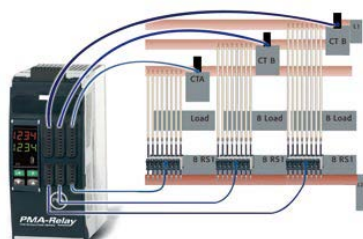

Use Relay-PC and you can add these Features

- Communication with different field bus
- Reading of current Voltage and Power
- Istantaneous power very close to average value, no pick power
- Power factor close to one no harmonics
- Prevents increase in energy supply tariffs imposed by your electricity supplier

APPLICATION WITH 8, 16 OR 24 SINGLE PHASE LOADS

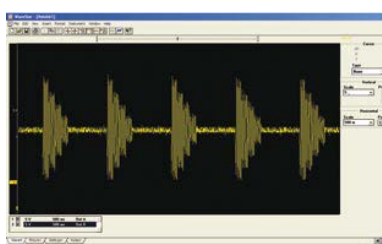

WITHOUT POWER CONTROL OPTIMISATION

Synchronization

On all controlled zones, Relay-PC Synchronization is automatic resulting in superior performance:

- Total current is equal to a sinusoidal wave form.
- Power factor > 0,9.
- Instantaneous current close to average value.
- Cancellation of harmonics.
- Flickering effect removed.

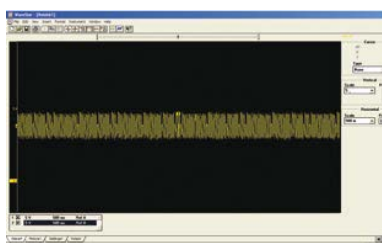

WITH POWER CONTROL OPTIMISATION

Smart power limitation

- Smart power limitation works together with synchronization. If this function is enabled, Relay-PC makes a live calculation of power at each period and generates the output values for the next period. If the calculated power is below the power limit value, the previous values remain with each channel using full power.
- If the power is above the power limit value, the setpoint of each channel is reduced proportionally to restrict power overshoot. This function significantly reduces disturbances on the main network compared to a full power system, preventing any increase in energy tariffs imposed by the electricity supplier.
- This function can be activated/deactivated and the limit value changed at any time.

Ordering Code Relay-PC

	1	2	3	4	5	6	7	8	9	10	11	12	13	14	15	16
Relay-PC	R	P	C	-	-	-	-	-	0	0	0	0	0	0	0	0

4,5 - Channels	
Description code	Numeric code
8 Channels	08
16 Channels	16
24 Channels	24

6 - Current Sensor	
Description code	Numeric code
N. 1 CS 200 Amps	1
N. 2 CS 200 Amps	2
N. 3 CS 200 Amps	3
N. 1 CS 400 Amps	4
N. 2 CS 400 Amps	5
N. 3 CS 400 Amps	6
N. 1 CS 600 Amps	7
N. 2 CS 600 Amps	8
N. 3 CS 600 Amps	9

7 - Communication	
Description code	Numeric code
Ethernet	1
ModBus Slave	2
ModBus Master	3
Profibus	4
Profinet	5
CANopen	6
EtherCAT	7

8 - Transformer	
Description code	Numeric code
Transformer 24V	1

Applications

- Chiller applications
- Autoclaves
- Thermoforming
- Dryers
- Chemical
- Infrared lamp
- Furnaces
- Extrusion line
- Climatic chambers
- Pharmaceutical

Wiring connection Relay S 2PH from 30 to 40A

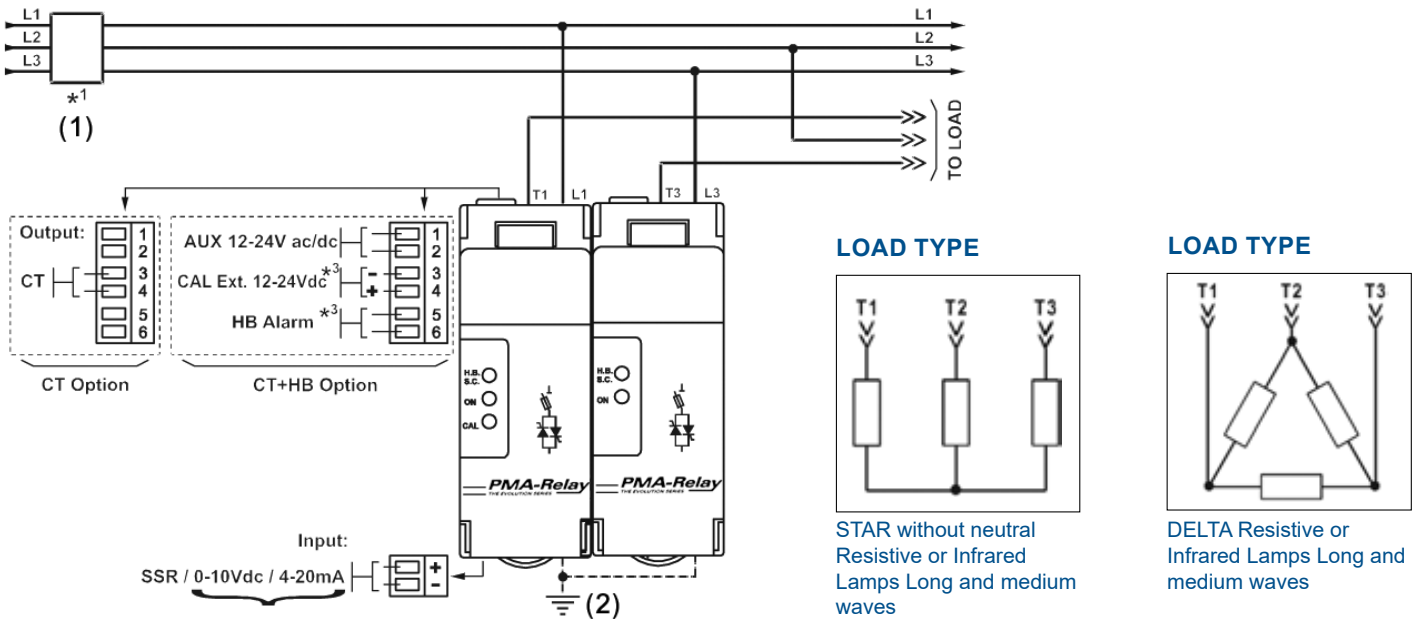

Notes

- A suitable device must ensure that the unit can be electrically isolated from the supply, this allows the qualified people to work in safety.
- The user installation must be protecting by electromagnetic circuit breaker or by fuse isolator. The semiconductor fuse are classified for UL as supplementary protection for semiconductor.
- The heat-sink must be connected to the earth.

Dimensions and fixing holes

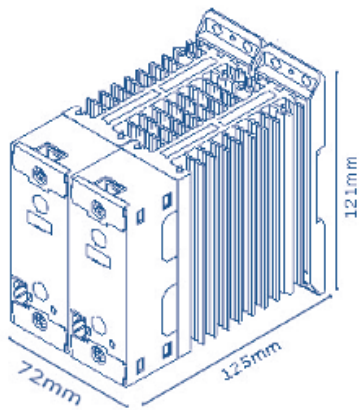

W 72 mm. - H 121 mm. - D 125 mm. - kg. 0,88
Relay S, No fuse 30A ÷ 40A

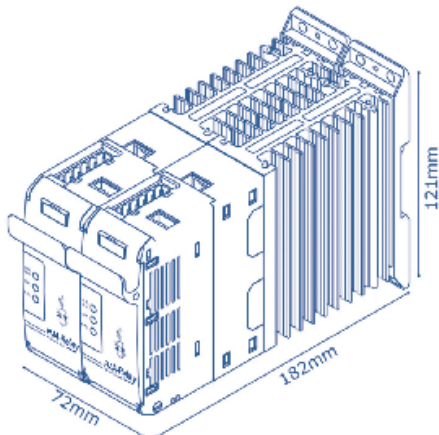
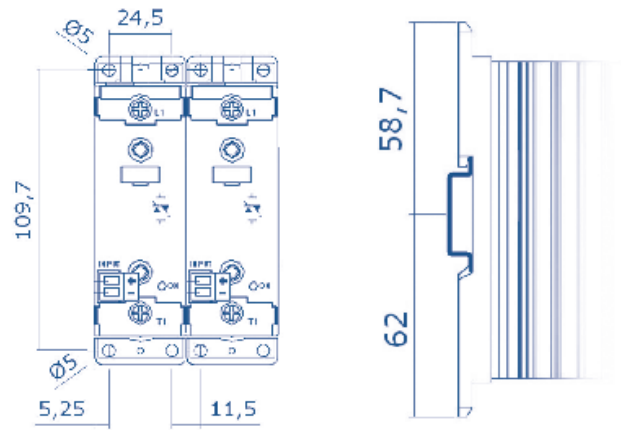

W 72 mm. - H 121 mm. - D 185 mm. - kg. 1,22
Relay S, with Fuse Holder 30A ÷ 40A

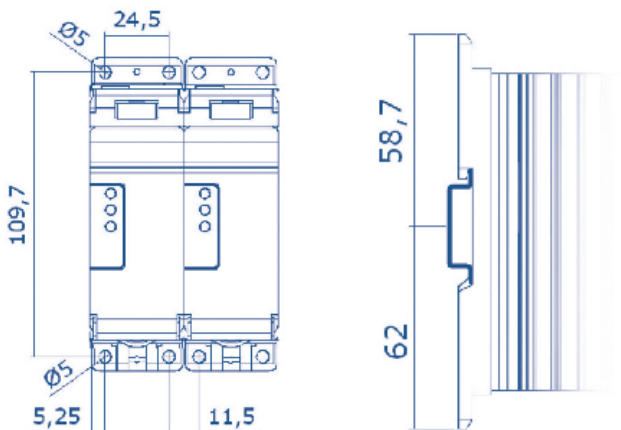

Output Features (power device)

Nominal current in continuous service:	See order code
Max peak current (10ms)	400A for unit type 030 600A for unit type 035 800A for unit type 040
Voltage range:	24+600V
Repetitive peak reverse voltage:	1200V (480V), 1600V (600V)
Latching current:	250mA
Leakage current:	15mA eff
I^2t value $t_p=10msec$:	780A ² /S for unit type 030 1750A ² /S for unit type 035 3110A ² /S for unit type 040
Frequency range:	47+70Hz
Power loss ($I=I_{nom}$):	76W for unit type 030 88W for unit type 035 100W for unit type 040
Isolation Voltage:	2500Vac

Ordering Code Relay S

<p>Max. Load Current Rating</p> <table border="0"> <tr><td>030</td><td>30A</td><td>210</td><td>210A</td></tr> <tr><td>035</td><td>35A</td><td>300</td><td>300A</td></tr> <tr><td>040</td><td>40A</td><td>350</td><td>350A</td></tr> <tr><td>060</td><td>60A</td><td>400</td><td>400A</td></tr> <tr><td>075</td><td>75A</td><td>450</td><td>450A</td></tr> <tr><td>090</td><td>90A</td><td>500</td><td>500A</td></tr> <tr><td>120</td><td>120A</td><td>600</td><td>600A</td></tr> <tr><td>150</td><td>150A</td><td>700</td><td>700A</td></tr> <tr><td>180</td><td>180A</td><td>800</td><td>800A</td></tr> </table>	030	30A	210	210A	035	35A	300	300A	040	40A	350	350A	060	60A	400	400A	075	75A	450	450A	090	90A	500	500A	120	120A	600	600A	150	150A	700	700A	180	180A	800	800A	<p>Aux. Voltage Supply</p> <p>0 No Aux. Voltage, without HB and/or without Analog Input up to 210A</p> <p>4 12:24V ac-dc 70mA, with HB and/or Analogue Input</p> <p>1 90:135V > 210A ⁽¹⁾</p> <p>2 180:265V > 210A ⁽¹⁾</p> <p>3 238:330V > 210A ⁽¹⁾</p> <p>5 342:528V > 210A ⁽¹⁾</p> <p>6 40:759V (600V) > 210A ⁽¹⁾</p> <p>7 540:759V (690V) > 210A ⁽¹⁾</p>	<p>Fan Voltage</p> <p>0 For 1 phase: No fan < 90A For 2 phase and 3 phase: No fan < 60A)</p> <p>1 For 1 phase: Fan 110V (≥ 90A) For 2 phase and 3 phase: Fan 110V (≥ 60A)</p> <p>2 For 1 phase: Fan 220V (≥ 90A) Std. Version For 2 phase and 3 phase: Fan 220V (≥ 60A) Std. version</p>
030	30A	210	210A																																			
035	35A	300	300A																																			
040	40A	350	350A																																			
060	60A	400	400A																																			
075	75A	450	450A																																			
090	90A	500	500A																																			
120	120A	600	600A																																			
150	150A	700	700A																																			
180	180A	800	800A																																			
<p>Model</p> <p>1 1 phase</p> <p>2 2 phase</p> <p>3 3 phase</p>	<p>Max. Load Voltage</p> <p>4 480V</p> <p>6 600V</p> <p>7 690V</p>	<p>Input</p> <p>S SSR</p> <p>V 0:10V dc ⁽²⁾</p> <p>A 4:20 mA ⁽²⁾</p>																																				
		<p>Firing</p> <p>Z Zero crossing</p> <p>4 Burst firing 4 cycles ⁽³⁾</p> <p>8 Burst firing 8 cycles ⁽³⁾</p> <p>6 Burst firing 16 cycles ⁽³⁾</p>																																				
		<p>Approvals</p> <p>0 CE</p> <p>L cUL + CE</p>																																				
		<p>Fuse & Option</p> <p>0 No fuse ⁽²⁾</p> <p>F Fuse and fuse holder up to 40A. From 60A fixed fuses</p> <p>H Fuse and fuse holder (up to 40A) / fixed fuses (from 60A) + current transmitter + heater break</p> <p>X Fuse and fuse holder + current transmitter + heater break + flat wiring up to 40A ⁽⁴⁾</p>																																				
		<p>Manual</p> <p>0 No manual</p> <p>1 Italian</p> <p>2 English</p> <p>3 German</p> <p>4 French</p>																																				

(1) Load voltage must be included in Selected Voltage Auxiliary Range for units > 210A

(2) With analogue input (0:10Vdc, 4:20mA) it is necessary to have the fuse (1 phase also the fuse holder on units =< 40 A)

(3) On at 50% power demand; Available only with analogue input

(4) Available up to 40A. With flat wiring it is necessary to use TU-RS1 (2;3) terminal unit

Contact

UK

Email: enquiries@west-cs.com
Website: www.west-cs.co.uk
Telephone: +44 (0)1273 606271
Address: The Hyde Business Park
 Brighton, East Sussex
 BN2 4JU
 United Kingdom

Brazil

Email: atendimento@ftvindtech.com
Website: www.west-cs.com.br
Telephone: 55 11 3616-0195 / 55 11 3616-0159

China

Email: china@west-cs.cn
Website: www.west-cs.cn
Telephone: +86 400 666 1802

France

Email: fr@west-cs.com
Website: www.west-cs.fr
Telephone: +33 171 84 1732

Germany

Email: de@west-cs.com
Website: www.west-cs.de
Telephone: +49 561 505 1307

USA

Email: inquiries@west-cs.com
Website: www.west-cs.com
Telephone: +1 800 866 6659