

# Solid State Relays, 2-phase controlled

Zero-Point switching, heatsink integrated



**Main Characteristics:**

Two-phase controlled  
 Zero switching  
 LED display  
 Various connection technologies  
 Plug-in control terminal  
 Degree of protection IP 20  
 Insulated mounting foot

**Standards / Approvals:**

DIN EN 60947-4-3  
 UL 508 / CSA<sup>1</sup>

CE  
 C-Ti

ck

**Ordering Key:**

<b>3RF24</b>	<b>10</b>	<b>- 1</b>	<b>A</b>	<b>B</b>	<b>4</b>	<b>5</b>
3-phase solid state contactor with heat sink	Max. load current 10 = 10,5 A 20 = 22 A 30 = 30 A 40 = 40 A 50 = 50 A	Connection technology 1 = Screw connection 2 = Spring-loaded connection 3 = Ring cable connection M5	Switching function A = Zero-point switching	Controlled phases B = two-phase	Control voltage 4 = 4 - 30 VDC 5 = 190 - 230 VAC	Operating voltage 5 = 48 - 600 V

Not all possible versions are available ex stock!

**Main Circuit:**

Values for 40 °C ambient temperature!	$I_{AC-51}$	$I_e$ acc. to IEC947-4-3	$I_e$ [50°C] UL/CSA	Power loss with $I_{AC-51}$	Min. load current	Max. leakage current
Type	A	A	A	W	A	mA
3RF2410-.AB.	10,5	7	7	23	0,1	10
3RF2420-.AB.	22	15	15	44		
3RF2430-.AB.	30	22	22	61		
3RF2440-.AB.	40	30	30	80		
3RF2450-.AB.	50	38	38	107		

Type		3RF24...AB.5
<b>Rated operating voltage</b> $U_e$	V	48 ... 600
	V	40 ... 660
	Hz	50/60 ± 10 %
<b>Rated insulation voltage</b> $U_i$	V	600
<b>Rated impulse withstand voltage</b> $U_{imp}$	kV	6
<b>Slew rate</b>	V/µs	1000

Type	Rated impulse withstand strength $I_{tsm}$	$I^2t$ value	Blocking voltage
A		$A^2s$ V	
3RF2410-.AB.	200	200	1200
3RF2420-.AB.	600	1800	1200
3RF2430-.AB.	1200	7200	1200
3RF2440-.AB.	1150	6600	1600
3RF2450-.AB.	1150	6600	1600

<sup>1</sup> Use overvoltage protection device; max cut-off-voltage 6.000 V; min energy handling capability 100 J

<b>Control Circuit A1-A2:</b>			
Type		3RF24...AB 5.	3RF24...AB 4.
Control voltage $U_s$	V	AC 190 ... 230	DC 4 ... 30
Max. control voltage $U_s$	V	253	30
Typical operating current	mA	15	30
Response voltage	V	180	4
Drop-out voltage	V	<40	<1
Rated frequency of the control supply voltage	Hz	50/60 $\pm$ 10 %	--
Switching times			
ON delay	ms	40 + Max. one half-wave	1 + Max. one half-wave
OFF delay	ms	40 + Max. one add. half-wave	1 + Max. one add. half-wave

<b>General Data:</b>			
<b>Ambient temperature</b>			
During operation	°C	-25 ... 60	
During storage	°C	-55 ... 80	
<b>Mounting altitude</b>	m	0 ... 1000; at > 1000 m, please contact our Technical Assistance	
<b>Impact resistance</b> acc. to DIN IEC 68	g/ms	15/11	
<b>Vibration resistance</b>	g	2	
<b>Degree of protection</b>		IP20	
<b>Electromagnetic compatibility (EMC)</b>			
Interference emission			
o Conducted interference voltage IEC 60 947-4-3		Class A for industrial applications <sup>2</sup>	
o Radiated, high-frequency interference voltage IEC 60 947-4-3		Class A for industrial applications	
Interference resistance			
o Electrostatic discharge acc. to IEC 61 000-4-2 (corresponds to severity 3)	kV	Contact discharge 4; air discharge 8; performance criterion 2	
o Induced HF fields acc. to IEC 61 000-4-6	MHz	0.15 ... 80; 140 dB $\mu$ V; performance criterion 1	
o Burst acc. to IEC 61 000-4-4	kV	2/5.0 kHz; performance criterion 1	
o Surge acc. to IEC 61 000-4-5	kV	Phase-to-ground 2; phase-to-phase 1; performance criterion 2	
<b>Dielectric Strength</b> 50/60 Hz (Input, Output / Base)	V rms	4000	

<sup>2</sup> **Attention!**

This product was constructed as an EMC Class A device. The use of this product in residential applications could lead to radio interferences. In such an application, additional filtering may be required.

Type		3RF24...-1.	3RF24...-2.	3RF24...-3.
Connection, main contacts		Screw connection	Spring-loaded connection	Ring cable connection
Conductor cross-section				
○ Solid	mm <sup>2</sup>	2 x (1.5 ... 2.5), 2 x (2.5 ... 6)	2x (0.5 ... 2.5)	
○ Finely stranded with end sleeve	mm <sup>2</sup>	2 x (1.5 ... 2.5), 2 x (2.5 ... 6), 1 x 10	2x (0.5 ... 1.5)	
○ Finely stranded w/o end sleeve	mm <sup>2</sup>		2x (0.5 ... 2.5)	
○ Solid or stranded	AWG	2 x (14 ... 10)	2 x (18 ... 14)	
Stripping length	mm	10	10	
Terminal screw		M 4	-	M 5
○ Tightening torque	Nm	2 ... 2.5	-	2 ... 2.5
D 5...6 mm / PZ 2	lb.in	18 ... 22	-	18 ... 22
Cable lug	DIN	-	-	DIN 46234 5-2.5 ... 5-25
JIS		-	-	JIS C 2805 R 2-5 ... 14-5
Connection, control contacts				
Conductor cross-section with or without end sleeve	mm <sup>2</sup>	1 x (0.5 ... 2.5)	0.5 ... 2.5	1 x (0.5 ... 2.5)
	mm <sup>2</sup>	2 x (0.5 ... 1.0)		2 x (0.5 ... 1.0)
	AWG	20 ... 12	20 ... 12	20 ... 12
Stripping length	mm	7	10	7
Terminal screw		M 3	-	M 3
○ Tightening torque	Nm	0.5 ... 0.6	-	0.5 ... 0.6
D 3.5 / PZ 1	lb.in	4.5 ... 5.3	-	4.5 ... 5.3

### Fused Design with Semiconductor Protection

Type	Full-range fuse LV HBC design gR/SITOR	Semiconductor protection fuse LV HBC design aR / 3NE80	Semiconductor protection fuse, cylindrical design		
			10 x 38 mm aR / SITOR	14 x 51 mm aR / SITOR	22 x 58 mm aR / SITOR
3RF2410-.AB.	3NE1813-0	3NE8015-1	3NC1012	3NC1415	3NC2220
3RF2420-.AB.	3NE1814-0	3NE8015-1	3NC1025	3NC1425	3NC2225
3RF2430-.AB.	3NE1803-0	3NE8003-1	3NC1032	3NC1432	3NC2232
3RF2440-.AB.	3NE1802-0	3NE8017-1	-	3NC1450	3NC2250
3RF2450-.AB.	3NE1817-0	3NE8018-1	-	3NC1450	3NC2263

### Accessories

Function module	Order No.	Applicable for	Versions
Converter	3RF2900-0EA18	3RF24...-AB 4.	Us = DC 24 V

## Characteristic Curves

3RF2410-

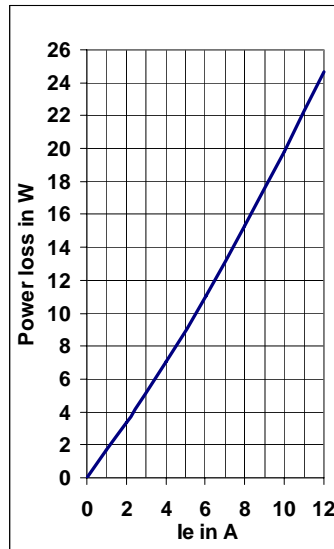
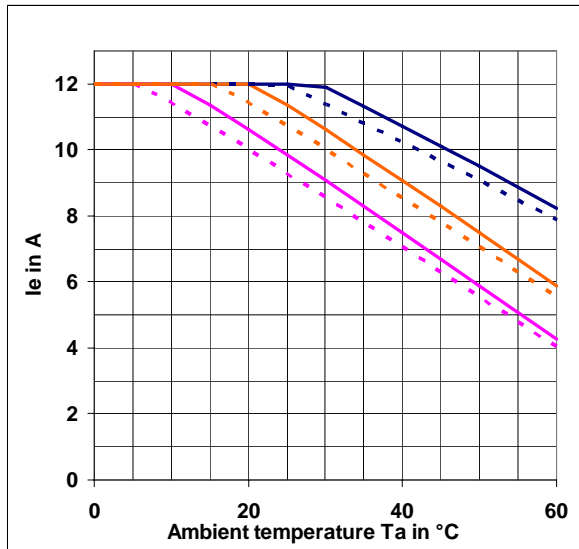

**Upper curves:**  
 $I_{\max}$  thermal limit current  
**Middle curves:**  
 Rated current  $I_e$  acc. to UL  
**Lower curves:**  
 Rated current  $I_e$   
 acc. to  
 DIN EN 60947-4-3

**Continuous lines:**  
 Stand-alone mounting  
**Dashed lines:**  
 Side-by-side mounting

3RF2420-

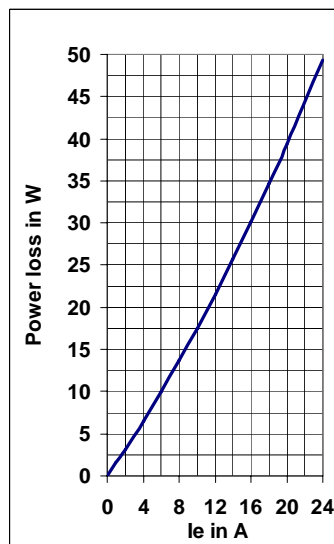
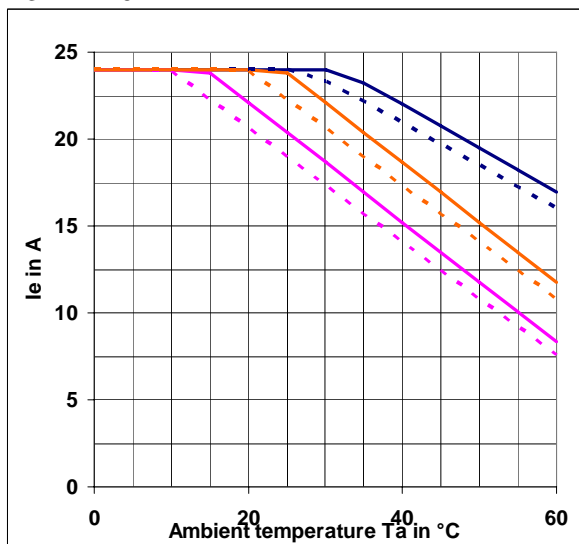

3RF2430-

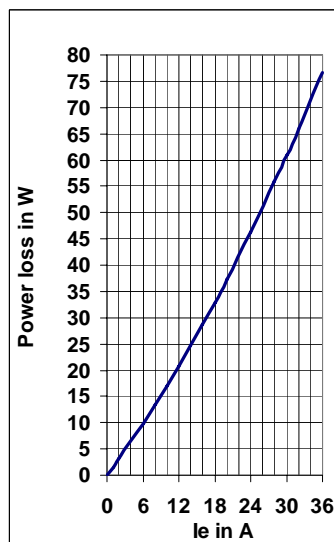
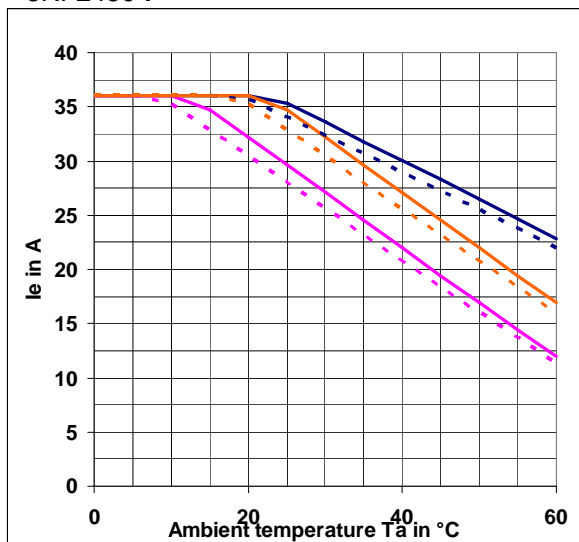

3RF2440-<sup>3</sup>

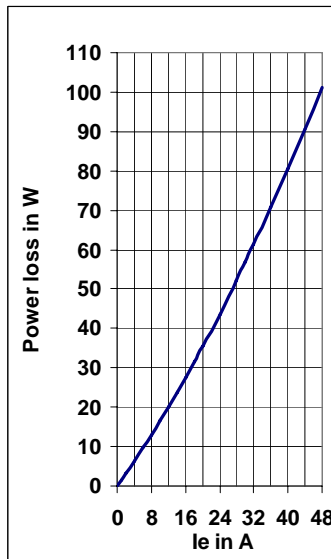
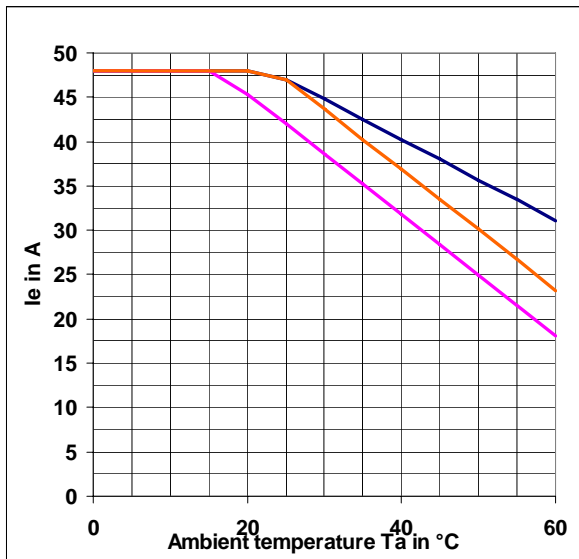

**Upper curves:**  
 $I_{max}$  thermal limit current  
**Middle curves:**  
 Rated current  $I_e$  acc. to UL  
**Lower curves:**  
 Rated current  $I_e$   
 acc. to  
 DIN EN 60947-4-3

For:  
 Stand-alone and side-by-  
 side mounting

3RF2450-<sup>3</sup>

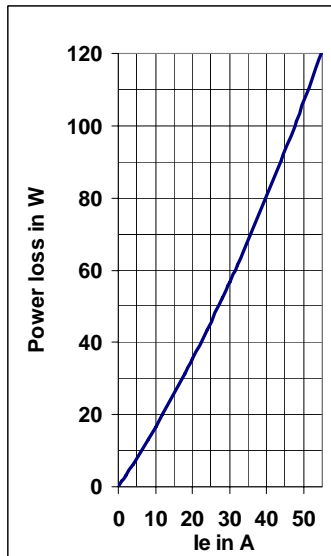
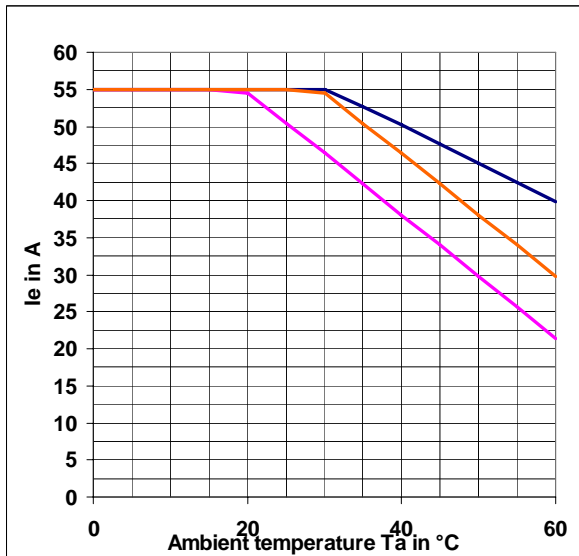

<sup>3</sup> Identical current/temperature curves for Stand-alone and side by side mounting.

**Mounting Instructions: <sup>4</sup>**

**3RF2410-AB..., 3RF2410-AC...,  
3RF2420-AB..., 3RF2420-AC...,  
3RF2430-AB...**

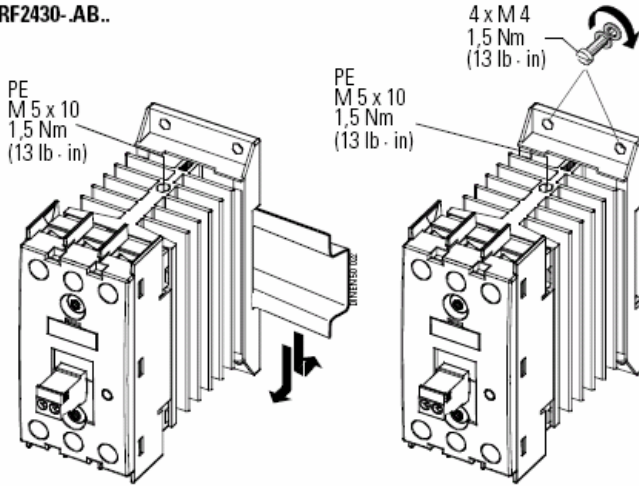

**3RF2430-AC...,  
3RF2440-AB..., 3RF2440-AC...,  
3RF2450-AB..., 3RF2450-AC...**

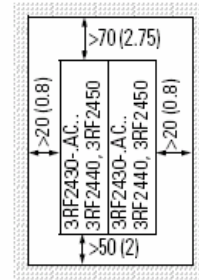
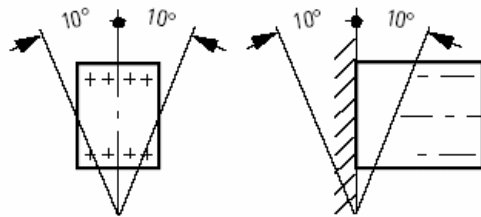
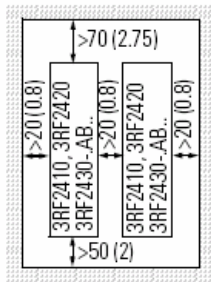
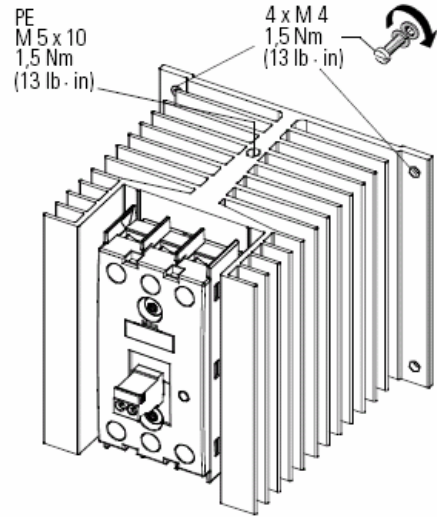

**Device / Example Circuit Diagram:**

**3RF24...-AB4.**

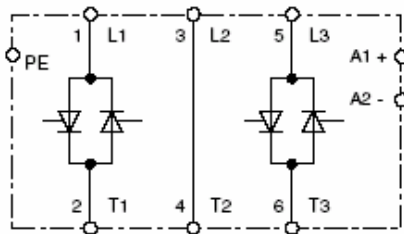

**DC 4 ... 30 V**

**3RF24...-AB5.**

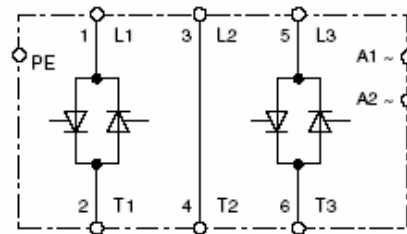

**AC 230 V**

<sup>4</sup> Dimensions in mm, (in);

Stand-alone mounting, Characteristic Curves shows derating for Side-by-side mounting

Subject to changes

## Dimension Drawings <sup>5</sup>:

3RF2410-.AB., 3RF2410-.AC.,  
3RF2420-.AB., 3RF2420-.AC.,  
3RF2430-.AB..

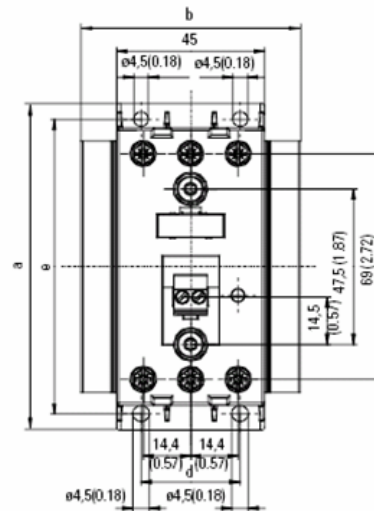
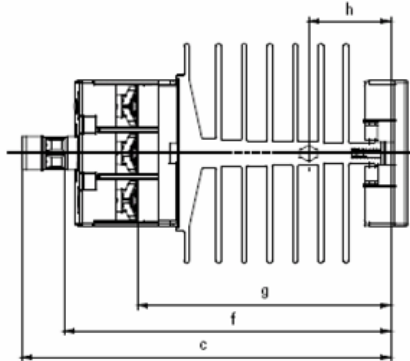

3RF2430-.AC.,  
3RF2440-.AB., 3RF2440-.AC.,  
3RF2450-.AB., 3RF2450-.AC..

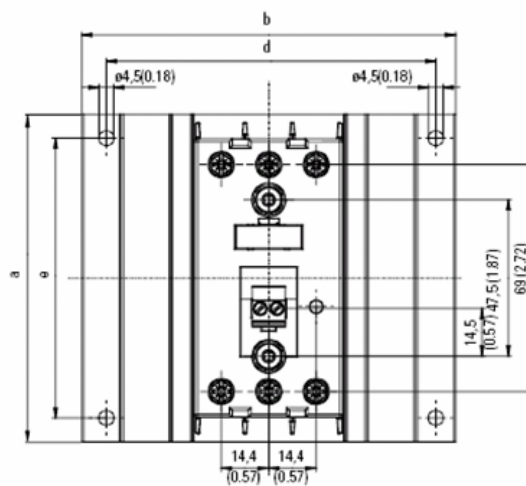
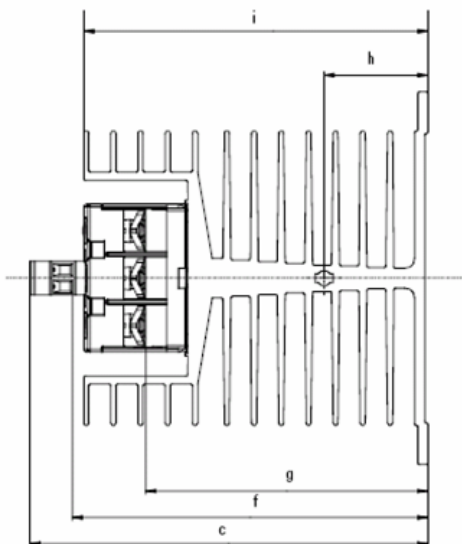

	a	b	c	d	e	f	g	h	i
3RF2410-.AC., 3RF2410-.AB..	100 (3.94)	45 (1.77)	104,5 (4.11)	30 (1.18)	90 (3.54)	91,5 (3.60)	69,5 (2.74)	25 (0.98)	–
3RF2420-.AB..	100 (3.94)	67 (2.64)	112,5 (4.43)	30 (1.18)	90 (3.54)	99,5 (3.92)	77 (3.03)	25 (0.98)	–
3RF2420-.AC., 3RF2430-.AB..	100 (3.94)	89,5 (3.52)	112,5 (4.43)	30 (1.18)	90 (3.54)	99,5 (3.92)	77 (3.03)	25 (0.98)	–
3RF2430-.AC., 3RF2440-.AB..	100 (3.94)	113,5 (4.47)	121 (4.76)	100 (3.94)	85 (3.35)	108 (4.25)	86 (3.39)	31,5 (1.24)	104,5 (4.11)
3RF2440-.AC., 3RF2450-.AB..	100 (3.94)	157,5 (6.20)	121 (4.76)	146 (5.75)	80 (3.15)	108 (4.25)	86 (3.39)	31,5 (1.24)	104,5 (4.11)
3RF2450-.AC..	180 (7.09)	157,5 (6.20)	121 (4.76)	146 (5.75)	160 (6.30)	108 (4.25)	86 (3.39)	31,5 (1.24)	104,5 (4.11)

<sup>5</sup> Dimensions in mm, (in)



**PMA**

Prozeß- und Maschinen- Automation GmbH  
P.O. Box 31 02 29  
D-34058 Kassel  
Tel.: +49 - 561- 505 1307  
Fax: +49 - 561- 505 1710  
E-mail: [mailbox@pma-online.de](mailto:mailbox@pma-online.de)  
Internet: <http://www.pma-online.de>

**Your local representative:**