



rail line System components

Fieldbus coupler for UNIFLEX CI 45,
KS 45, and TB 45

Port for PROFIBUS-DP

Ethernet MODBUS/TCP

Compact design

Centralized energization

Power supply modules

rail line

FEATURES

- Fieldbus port for rail line function modules
 - Transmitter UNIFLEX CI 45
 - Universal controller KS 45
 - Temperature limiter TB 45
- Supported fieldbuses:
 - PROFIBUS DP with DPV1 protocol
- Ethernet TCP/IP with MODBUS/TCP protocol
- Compact design, only 22.5 mm wide
- Clips onto top-hat DIN rail
- Plug-in screw terminals or spring-clamp connectors
- Direct communication between rail-mounted transmitters
- Centralized 24 VDC supply
- Function modules replaceable during operation (hot swap)
- Central configuration support via BlueControl®
- 2 data formats (integer & float)

APPLICATIONS

- ⊕ Decentralized acquisition of process signals and control of processes
- ⊕ Remote I/O system
- ⊕ Linking into fieldbus systems

- ⊕ Component-oriented system structure with distributed intelligence

DESCRIPTION

Construction

A *rail line* system consists of a fieldbus coupler, and various rail-mounted function modules, for example:

- UNIFLEX CI 45 transmitters for precise and cost-effective signal detection and processing tasks.
- Universal controller KS 45 for a wide range of control tasks
- Temperature limiter TB 45 for reliable monitoring/limiting tasks

Connections between the modules are made by means of a bus connector clipped to the top-hat rail.

Power supply

System energization (24 VDC) is provided via the fieldbus coupler from a central power supply. The function modules are supplied internally.

Mounting

The bus connectors are clipped to one end of the top-hat rail. The *rail line* modules are also clipped to the rail, and pushed up close to each other, thus providing a connection to the bus. Unmounting the modules is just as simple.

All connections are of the plug-in type, so that a module can be replaced very quickly without disturbing the wiring.

Interfaces and Engineering Tools

The fieldbus coupler as well as the connected function modules, can be configured with the BlueControl® software via the BluePort® interface. System data can be stored in a project file.

Data exchange

The process data that is to be transmitted can be defined in the Engineering for every function module. Up to 15 values can be read or written. The data are always available in the bus coupler, thus ensuring fast responses to requests.

Similarly, the fieldbus interface can be used to transfer the complete Engineering.

Construction

Up to 16 function modules can be connected to each fieldbus coupler. If additional power supply modules are fitted, up to 62 function modules can be addressed by a single fieldbus coupler.

TECHNICAL DATA

SYSTEM STRUCTURE

A basic system consists of a fieldbus coupler and several stack-mounted function modules.

Available modules	UNIFLEX CI 45, KS 45, TB 45 (versions with system interface)
Number of modules per bus coupler:	16 *
Connection:	direct, via system bus in the top-hat rail
expandable:	to 62 **
Distribution in levels:	max. 4
Max. stacked length:	10 m
Distance between levels:	max. 3 m

* preliminary (depends on power requirements)

** via power supply modules (max. 16 units per power supply module, see above)

FIELDBUS COUPLER

PROFIBUS-DP

PROFIBUS-DP slave interface to IEC 61158

Reading & writing of process data, parameters, and configuration data for DPV0.

A-cyclical DPV1 services for Master Classes 1 and 2

Connection via PROFIBUS Sub-D connector

Physical connection: RS 485
Transmission speed: 9.6...1,200 kBit/s self-adapting

Address range: 1...99
via rotary switch

Number of units per bus segment: 32

Cable lengths

Bit rate	max. length per segment
9.6 ... 93.75 kbits/s	1,200 m
187.5 kbits/s	1,000 m
500 kbits/s	400 m
1.5 Mbits/s	200 m
3 ... 12 Mbits/s	100 m

Terminating resistor

external, fitted in connector

Cable

to IEC 61158, Type A.

Protocol

- PROFIBUS DPV1

Fig.: 1: Dimensions RL DP

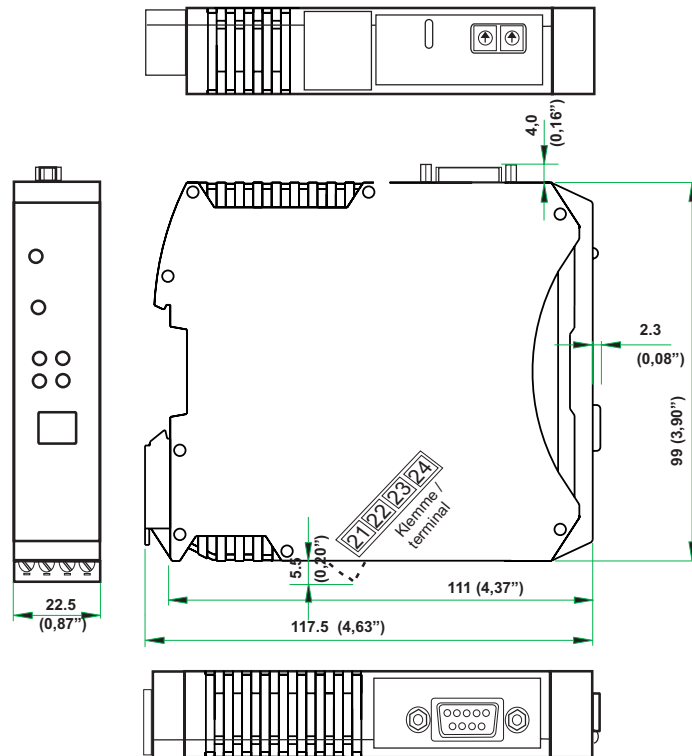

Fig.: 2: communicative possibilities

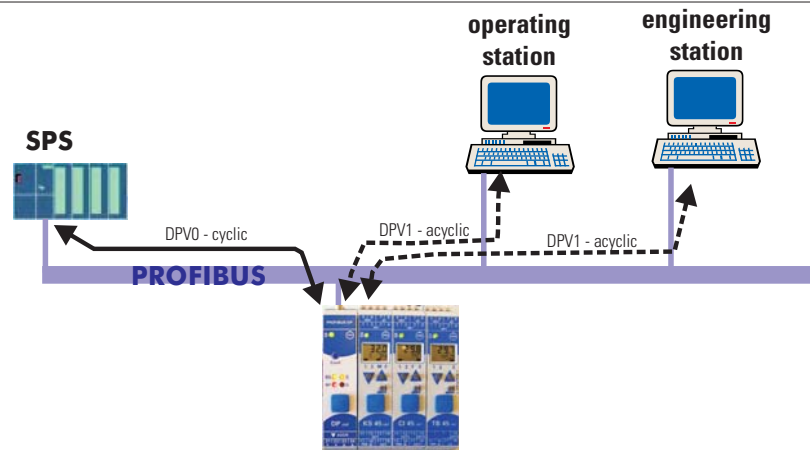
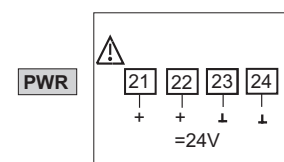
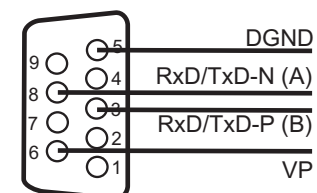

Fig.: 3: Buscoupler PROFIBUS DP



Fig.: 4: Connection buscoupler



GSD file

on PMA homepage

DPV1 functions

The extended PROFIBUS functions for DPV1 can be used for the standardized, non-cyclical transmission of parameters, etc. RLDP supports the following non-cyclical DPV1 services:

- a connection to the DP Class 1 Master (e.g. PLC): Read, Write, Alarm, Alarm_Ack.
- two connections to the DP Class 2 Master (e.g. operating/engineering stations): Initiate, Abort, Read, Write

Upload/download of an Engineering via the PROFIBUS between BlueControl® and RLDP is possible via the DPV1 services (for PROFIBUS links supplied by Hilscher, e.g. CIF50-PB, CIF60-PB).

DISPLAY AND OPERATION

Indicator LEDs

OK / Err. (3-colour):	device status
BS (yellow):	fieldbus status
BF (red):	faulty parameter or configuration telegram
S (yellow):	system bus status
D (yellow):	diagnosis

Address selector

2 rotary coding switches 0...99

ETHERNET MODBUS/TCP

Ethernet interface with TCP/IP protocol, Reading & writing of process data, parameters, and configuration data via application protocol MODBUS/TCP.

Connection via RJ45-connector

Network connection

Ethernet RJ45 femal connector
10/100BaseT to IEEE802.3

Transmission speed

10 / 100 MBit/s

Cable

Copper conductors, twisted pair, 4 wires
Type Cat5

Fig. 7: Dimensions RL ETH

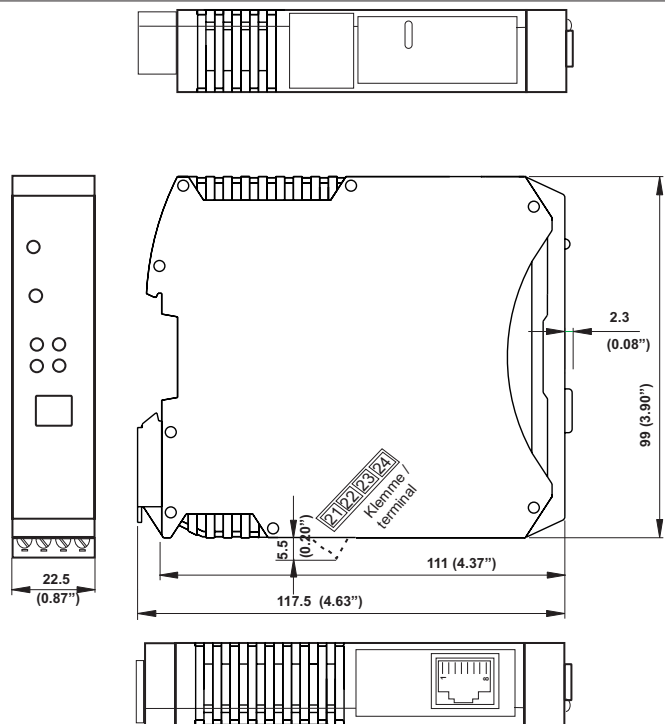

Permissible cable lengths

Ethernet segment length: 100 m
(with Cat5 cables)

Protocol

TCP/IP protocol
MODBUS/TCP - Server via port 502
Connectable to 4 Clients at the same time
max. 16 connections

DISPLAY AND OPERATION

Indicator LEDs

ok/err: (3-colour)	device status
BS (yellow):	fieldbus status
S (yellow):	system bus status
RX (yellow):	Ethernet data receiving
TX (yellow):	Ethernet data transmission

Adress selection

by means of Engineering Tool BlueControl® or BOOTP protocol

Fig. 5 Bus coupler Ethernet



Fig. 6: Connections RL ETH

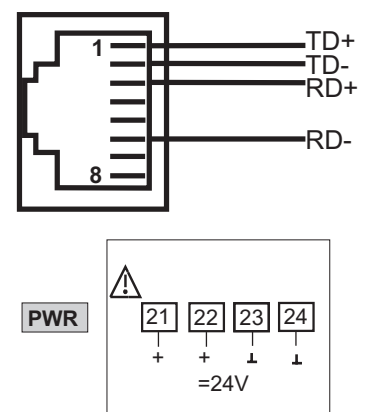

GENERAL TECHNICAL DATA

POWER SUPPLY

24 VDC supply

Voltage:	19,2...30 VDC
Power consumption of bus coupler:	max. 4 W
Power for module energization:	max. 5 A

Supply only with safe low voltages (SELV)

Protected against reversed polarity and overvoltage

Behaviour with power failure

System configuration: Permanent storage in EEPROM

BLUEPORT® FRONT INTERFACE

Connection to the module front via a PC adapter (see 'Accessories').

The BlueControl® software enables

- the fieldbus coupler and
- the connected modules

to be configured, parameters set, and operated.

SYSTEM INTERFACE

Internal bus for connecting modules via the system interface.

Connection via bus connector fitted in the top-hat rail.

ENVIRONMENTAL CONDITIONS

Protection class

Module front:	IP 20
Housing:	IP 20
Terminals:	IP 20

Permissible temperatures

Operation:	-10...55 °C
Storage:	-25...60 °C
Transport:	-25...85°C

Humidity

KUF to DIN 40 040

75% yearly average, no condensation

Shock and vibration

Vibration test Fc (DIN EN 60068-2-6)

Loading:	5 g
Duration:	2 h in every axis

Shock test Ea (DIN EN 60068-2-27)

Shock:	25 g
Duration:	11 ms

Electromagnetic compatibility

Complies with EN 61 326-1 for continuous, unattended operation.

Emissions:

- within the limits for Class A devices.

Immunity:

complies with the test requirements for devices used in industrial areas.

GALVANIC ISOLATION

Supply voltage, fieldbus, and logic circuits are isolated from each other.

Insulation voltage: 500 VDC

GENERAL

Housing front

Material: Polyamide PA 6.6
Flammability class: V0 (UL 94)

Connecting terminals

Material: Polyamide PA
Flammability class:
V0 (UL 94) for screw terminals
V0 (UL 94) for bus connectors

System bus connectors

Insertions under load: max. 5

Electrical safety

Complies with EN 61 010-1:Over-voltage category II

Contamination degree 2

Protection class II

Electrical connections

Plug-in connector strips with choice of terminal type:

- Screw terminals or spring-clamp terminals, both for lead cross-sections from 0.2 to 2.5 mm².

Mounting

Clip-on rail mounting (35 mm top-hat rail to EN 50 022).

Locked by means of metal catch in housing base.

Stacked mounting possible.

Mounting position: vertical

Weight:

0.16 kg

Standard accessories

- Operating instructions
- Bus connector for fitting into top-hat rail
- Connection for power supply: screw terminal connector

CERTIFICATIONS

- CE (standard)
- cULus-certification (Type 1, indoor use)
File: E 208286

Fig.: 8: System assistant

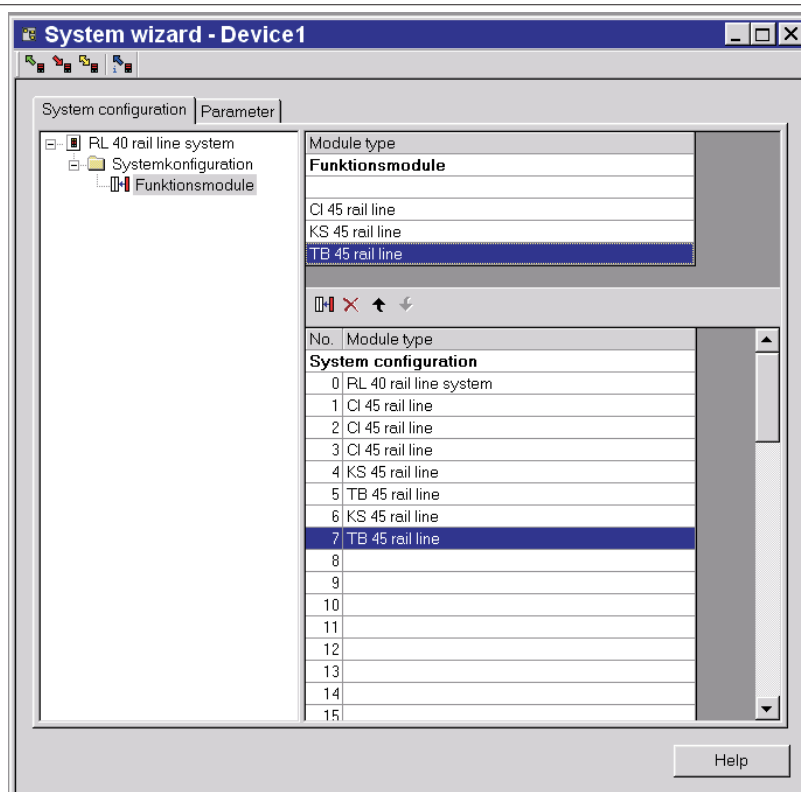

ACCESSORIES

POWER SUPPLY MODULE

Applications

- Supplementary supply of additional modules
- Distribution in different installation levels
- Provision of separated potential levels

* Note:

- No stacked mounting with other system modules permitted (fieldbus coupler, other supply modules)

- Bus connection has to be realized locally by means of plugs for bus connection (see accessories ④, ⑤)

Available modules: UNIFLEX CI 45, KS 45, TB 45
(versions with system interface)

Number of modules per supply module: 16 *

Connection: direct, via system bus in the top-hat rail

Performance data: see fieldbus coupler

BLUECONTROL® (ENGINEERING TOOL)

PC software package for system configuration, parameter setting, and operating (commissioning) the fieldbus coupler.

Central Engineering Tool for configuring, parameter setting, and operating the connected function modules.

Software requirements:

Windows 95/98/NT/2000/XP

Hardware requirements:

A special PC adapter (see 'Additional Accessories') is required for connecting to the device.

Updates and demo software from:

www.pma-online.de

ORDERING INFORMATION SYSTEMCOMPONENTS

System components

Fieldbus coupler PROFIBUS DP **RL40-112-00000-000**

Fieldbus coupler PROFIBUS DP, cULus certified **RL40-112-00000-U00**

Fieldbus coupler Ethernet MODBUS/TCP **RL40-114-00000-000**

Fieldbus coupler Ethernet MODBUS/TCP, cULus certified **RL40-114-00000-U00**

Power supply module **RL40-119-00000-000**

Power supply module cULus certified **RL40-119-00000-U00**

Operation note function modules: with system interface

Transmitter UNIFLEX CI 45 **CI45-1xY-2xxxx-xxx**
↳ Y = 3,5

Universal controller KS 45 **KS45-1xY-2xxxx-xxx**
↳ Y = 1,3,5

Temperature limiter TB 45 **TB45-1xY-2xxxx-xxx**
↳ Y = 1,3

➤ Please also order the associated documentation:

DOCUMENTATION

Description	Order-No.
Interface description rail line System PROFIBUS (D)	9499-040-77118
Interface description rail line System PROFIBUS (E)	9499-040-77111
Parameter adresslist rail line system PROFIBUS (D)	9499-040-78118
Parameter adresslist rail line system PROFIBUS (E)	9499-040-78111

ACCESSORIES

Description	Order-No.
① connector-set screw terminal	4 pcs. 9407-998-07101
② connector-set spring-clamp terminal	4 pcs. 9407-998-07111
③ Top-hat rail bus-connector	1 pcs. 9407-998-07121
④ Plug for bus connection, inverted, connections at left, horizontal cable entry	1 pcs. 9407-998-07131
⑤ Plug for bus connection, connections at right, vertical cable entry	1 pcs. 9407-998-07141

ADDITIONAL ACCESSORIES

Description	Order-No.
PC adapter for the BluePort® front interface	9407-998-00001
USB serial adaptor (USB to RS 232)	9407-998-00081
Converter RS 232 to RS 422/485 galv. isolated	ADAM-4520-D
BlueControl® Mini	www.pma-online.de
BlueControl® with Basic license rail line	9407-999-12001
BlueControl® with Expert license rail line	9407-999-12011



Germany

PMA
Prozeß- und Maschinen-Automation GmbH
Miramstraße 87, D-34123 Kassel
Tel.: +49 561 505 - 1307
Fax: +49 561 505 - 1661
E-mail: export@pma-online.de
Internet: <http://www.pma-online.de>

Your local distributor