

Thyristor-Power Controller

PMA-Relay S 1PH

from 300A to 800A

User Manual



PMA-S1-300-800A

A publication of:

PMA
Prozeß- und Maschinen-Automation GmbH
P.O.Box 310 229 • D-34058 Kassel • Germany

All rights reserved.

No part of this document may be reproduced or published in any form or by any means without prior written permission from the copyright owner.

Liability and warranty

Any information and notes in these operating instructions were composed under consideration of the applicable regulations, the present state of the art and our extensive know-how and experience.

With special versions, additional ordering options or due to the latest technical modifications, the actual scope of delivery may vary from the descriptions and drawings in this manual. For questions, please, contact the manufacturer.



Before starting to work with the instrument and before commissioning, in particular, these operating instructions must be read carefully! The manufacturer cannot be held responsible for damage and trouble resulting from failure to comply with the information given in this manual.

This product may be subject to change due to improvements of the product features in the course of further development.

Copyright

This operating manual should be considered as confidential information, intended only for persons who work with the instrument.

Contraventions are subject to payment of damages. Further claims reserved.

Inhalt

1.	Important warnings for safety.....	5
1.1.	Safety notes.....	5
2.	Maintenance.....	7
3.	Basic Connections.....	8
4.	Identification and Order Code.....	9
4.1.	Identification of the unit	9
5.	Order Code	10
6.	Technical Specifications.....	11
6.1.	General features.....	11
6.2.	Input features.....	11
6.3.	Output features (power device).....	11
6.4.	Fan Specification.....	11
6.5.	Environmental installation conditions	12
6.6.	Derating Curve.....	12
6.7.	Calculating flow capacity of the fan	12
7.	Installation.....	13
7.1.	Dimensions and weight	14
7.2.	Fixing holes.....	14
8.	Wiring instructions	15
8.1.	Removing the cover.....	15
8.2.	Line power and Load cable/bar dimensions and torque (suggested).....	15
8.3.	Cable dimensions (suggested) of Earth and of the Command Terminals.....	16
8.4.	Terminals Positions.....	16
8.5.	Power Terminals.....	17
8.6.	Control Terminals	17
8.6.1.	terminal block M1	17
8.6.2.	terminal block M2	17
8.7.	Schematic	18
8.7.1.	SSR Control Input schematic	19
8.8.	Connection Diagram for Single-phase.....	19
8.9.	Led status and alarms.....	20
9.	Heater Break alarm and SCR short circuit (HB Option only)	21
9.1.	Heater break Calibration procedure	21
10.	Input Setting.....	22
11.	Burst Firing settings.....	23







12.	Firing type	24
12.1.	Zero Crossing (for SSR Input only).....	24
12.2.	Burst Firing (for Analog Input option only)	24
13.	Supply the electronic board	25
14.	Internal Fuse	26
14.1.	Fuses Replacement	27

1. Important warnings for safety

This chapter contains important information for the safety. The not observance of these instructions may result in serious personal injury or death and can cause serious damages to the Thyristor unit and to the components system included.

The installation should be performed by qualified persons.

In the manual are used symbols to give more evidence at the notes of safety and operativity for the attention for the user:

	This icon is present in all the operational procedures where the Improper operation may result in serious personal injury or death by Electrical Shock Hazard Symbol (a lightning bolt in a triangle) precedes an electric shock hazard CAUTION or WARNING safety statement.
	Warning or Hazard that needs further explanation than the label on unit can provide. Consult User's Guide for further information.
	Unit is compliant with European Union directives. See Declaration of Conformity for further details on Directives and Standards used for Compliance.
	If available, unit is a Listed device per Underwriters Laboratories. It has been investigated to ANSI/UL® 508 standards for Industrial Control Switches and equivalent to CSA C22.2 #14. For more detail search for File E505847 on www.ul.com
	ESD Sensitive product, use proper grounding and handling techniques when installing or servicing product.
	Do not throw in trash, use proper recycling techniques or consult manufacturer for proper disposal.

A “**NOTE**” marks a short message to alert you to an important detail.

A “**CAUTION**” safety alert appears with information that is important for protecting your equipment and performance. Be especially careful to read and follow all cautions that apply to your application.

A “**WARNING**” safety alert appears with information that is important for protecting you, others and equipment from damage. Pay very close attention to all warnings that apply to your application.

1.1. Safety notes



WARNING! To avoid damage to property and equipment, injury and loss of life, adhere to applicable electrical codes and standard wiring practices when installing and operating this product. Failure to do so could result in damage, injury and death.



WARNING! All service including inspection, installation, wiring, maintenance, troubleshooting, fuse or other user serviceable component replacement must be performed only by properly qualified personnel. Service personnel must read this manual before proceeding with work. While service is being performed unqualified personnel should not work on the unit or be allowed in the immediate vicinity.



WARNING! When in use the power controller is connected to dangerous voltages. Do not remove the protective covers without first disconnecting and preventing power from being restored while servicing the unit.



WARNING! Do not use in aerospace or nuclear applications.



WARNING! The power controller's protection rating is IP20 with all covers installed and closed. It must be installed in an enclosure that provides all the necessary additional protections appropriate for the environment and application.



WARNING! Ground the power controller via the provided protective earth grounding terminal. Verify ground is within impedance specifications. This should be verified periodically.



WARNING! Electric Shock Hazard: when the power controller has been energized, after shutting off the power, wait at least one minute for internal capacitors to discharge before commencing work that brings you in to contact with power connections or internal components.



WARNING! The installation must be protected by electromagnetic circuit breakers or by fuses. The semiconductor fuses located inside the power controller are classified for UL as supplementary protection for semiconductor devices. They are not approved for branch circuit protection.



WARNING! When making live voltage or current measurements, use proper personal protective equipment for the voltages and arc-flash potentials involved.



WARNING! Verify the voltage and current ratings of the power controller are correct for the application.



CAUTION: To avoid compromising the insulation, do not bend wire or other components beyond their bend radius specifications.



CAUTION: Protect the power controller from high temperature, humidity and vibrations.



CAUTION: The power controller warranty is void if the tested and approved fuses are not used.



CAUTION: Only trained and authorized personnel should access and handle the internal electronics and they must follow proper electro-static prevention procedures.



CAUTION: Install an appropriately sized RC filter across contactor coils, relays and other inductive loads.



CAUTION: The thyristor units here described have been designed for use with sinusoidal networks with nominal frequency 50-60 Hz. Any application with NON-SINUSOIDAL, distorted or disturbed networks could compromise the correct operation of the unit.



NOTE: Provide a local disconnect to isolate the power controller for servicing.



NOTE: The nominal current is specified for ambient temperatures at or below 40° C. Ensure the application design allows for adequate cooling of each power controller. The power controller must be mounted vertically. The cooling design must prevent air heated by one power controller from causing power controllers mounted above to exceed the ambient operating temperature limit. When power controllers are mounted side by side allow a minimum spacing of 15mm between them.



NOTE: Use only copper cables and wires rated for use at 75°C or greater.

2. Maintenance

In order to have a corrected cooling, the user must clean the heat-sink and the protective grill of the fans.

The frequency of this servicing depends on environmental pollution.

Also check periodically if the screw for the power cables and safety earth are tightened correctly (See Connection Diagram)

3. Basic Connections

Single phase wiring with resistive load

$$I = \frac{P}{V}$$

V = Nominal voltage of the load

I = Nominal current of the load

P = Nominal power of the load

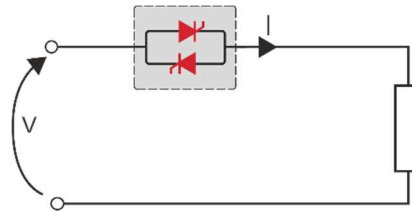

Single phase wiring with inductive load

$$I = \frac{P}{V \cos \varphi}$$

V = Nominal voltage phase to phase

I = Nominal current of the load

P = Nominal power of the load

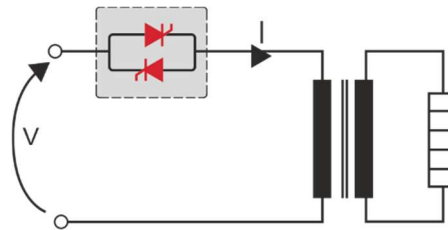

Open Delta wiring with resistive load

$$I = \frac{P}{3V}$$

V = Nominal voltage of the load

I = Nominal current of the load

P = Nominal power of the load

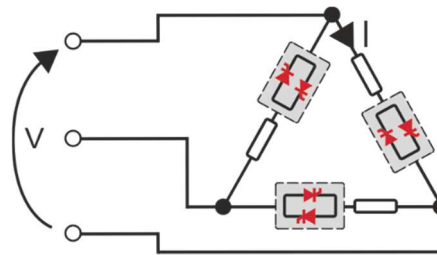

4. Identification and Order Code

4.1. Identification of the unit



Caution: Before to install, make sure that the Thyristor unit have not damages. If the product has a fault, please contact the dealer from which you purchased the product.

The identification label give all the information regarding the factory settings of the Thyristor unit, this label is on the unit, like represented in figure.

Verify that the product is the same thing as ordered.

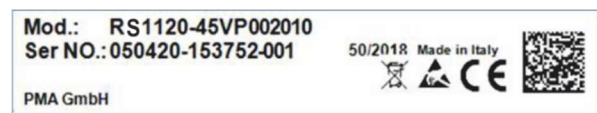

5. Order Code

	RS1	x	0	0	-	x	x	x	x	0	x	x	x	x	x
Current Rating		↓	↓	↓											
300 A		3	0	0											
400 A		4	0	0											
500 A		5	0	0											
600 A		6	0	0											
700 A		7	0	0											
800 A		8	0	0											
Max Voltage					↓										
480 V					4										
600 V					6										
690 V					7										
Aux. Voltage Supply	Since the supply voltage of the electronics is used for synchronization, it must be in phase with the load voltage.														
Supply voltage of the electronics	Max. Operating voltage														
100/120 Vac	90 to 135 Vac				1										
200/208/230/240 Vac	180 to 265 Vac				2										
277 Vac	238 to 330 Vac				3										
380/415/480 Vac	342 to 528 Vac				5										
600 Vac	540 to 759 Vac				6										
690 Vac	540 to 759 Vac				7										
Input signal															
(SSR)						S									
0:10 V dc						V									
4:20 mA						A									
Firing															
ZC Zero Crossing						Z									
Burst Firing 4 Cycles On at 50% Power Demand (Available only with Analog Input)						4									
Burst Firing 8 Cycles On at 50% Power Demand (Available only with Analog Input)						8									
Burst Firing 16 Cycles On at 50% Power Demand (Available only with Analog Input)						6									
Control Mode															
Open Loop							0								
Fuses & Option															
Fixed Fuses								F							
Fixed Fuses + CT + HB								H							
Fan Voltage															
Fan 110Vac									1						
Fan 220Vac Std Version									2						
Fan 24Vdc									3						
Approvals															
CE EMC For European Market										0					
cUI + CE EMC For American and European Market										L					
Manual															
None													0		
Italian														1	
English														2	
German														3	
French														4	
Version															
Standard version															1
High Sensitivity HB below 5A															5

6. Technical Specifications

6.1. General features

Cover and Socket material	PolymericV2
Utilization Category	AC-51 AC-55b AC-56A
IP Code	20
Method of Connecting	Single Phase load
Auxiliary voltage: (8 VA Max) Order code RS1___-1 = line voltage 100/120V voltage range 90:135V Order code RS1___-2 = line voltage 200/208/220/230/240V voltage range 180:265V Order code RS1___-3 = line voltage 277 voltage range 238:330V Order code RS1___-5 = line voltage 380/400/415/440/480V voltage range 342:528V Order code RS1___-6 = line voltage 600V voltage range 540:759V Order code RS1___-7 = line voltage 690V voltage range 540:759V	
Relay output for Heater Break Alarm (only with HB option)	0.5A a 125VAC



6.2. Input features

Analog Input V	0 ÷ 10Vdc (15 kΩ)
Analog Input A	0 ÷ 20mA / 4 ÷ 20mA (100 Ω)
POT	10kΩ min.
Digital Input	4 ÷ 30Vdc 5mA Max (ON >4Vdc OFF <1Vdc) 3HZ Max duty cycle min. 100 ms

6.3. Output features (power device)

Current	Nominal Voltage range (Ue)	Repetitive peak reverse voltage (Uimp)		Latching current	Max peak one cycle	Leakage current	FUSE I2T value Suggested A2s (at500V)	Frequency range	Power loss Thyristor + Fuse	Isolation Voltage (Ui)
		(480V)	(600V)							
(A)	(V)			(mAeff)	(10msec.) (A)	(mAeff)	tp = 10msec.	(Hz)	I=Inom (W)	(V)
300	24÷600	1200	1600	200	7800	15	73500	47÷70	443	3000
400	24÷600	1200	1600	200	7800	15	150500	47÷70	547	3000
500	24÷600	1200	1600	1000	17800	15	294000	47÷70	591	2500
600	24÷600	1200	1600	1000	17800	15	246400	47÷70	832	2500
700	24÷600	1200	1600	1000	17800	15	246400	47÷70	945	2500
800	24÷600	1200	1600	1000	15000	15	246400	47÷70	1144	2500

6.4. Fan Specification

Supply		Size	Number of fans	CE	Number of fans	UL LISTED
230Vac Standard	S12	300A, 400A, 500A, 600A	One Fan 16W		Two Fans 32W (2 x 16W)	
	S12	700A	Two Fans 32W (2 x 16W)		Two Fans 32W (2 x 16W)	
	S15	800A	Two Fans 32W (2 x 16W)		Two Fans 32W (2 x 16W)	
115Vac Option	S12	300A, 400A, 500A, 600A	One Fan 14W		Two Fans 28W (2 x 14W)	
	S12	700A	Two Fans 28W (2 x 14W)		Two Fans 28W (2 x 14W)	
	S15	800A	Two Fans 28W (2 x 14W)		Two Fans 28W (2 x 14W)	
24Vac Option	S12	300A, 400A, 500A, 600A	One Fan 7W		Two Fans 14W (2 x 7W)	
	S12	700A	Two Fans 14W (2 x 7W)		Two Fans 14W (2 x 7W)	
	S15	800A	Two Fans 14W (2 x 7W)		Two Fans 14W (2 x 7W)	

6.5. Environmental installation conditions

Ambient temperature	0-40°C (32-104°F) at nominal current. Over 40°C -104°F use the derating curve.
Storage temperature	-25°C to 70°C -13°F to 158°F
Installation place	Don't install at direct sun light, where there are conductive dust, corrosive gas, vibration or water and also in salty environmental.
Altitude	Up to 1000 meter over sea level. For higher altitude reduce the nominal current of 2% for each 100m over 1000m
Humidity	From 5 to 95% without condense and ice
Pollution Level	Up to 2nd Level ref. IEC 60947-1 6.1.3.2

6.6. Derating Curve

The nominal current of the units in specification are referred to continuous service at 40 ambient temperature.

For higher temperature multiply the nominal current times derating coefficient K as represented in the graph.

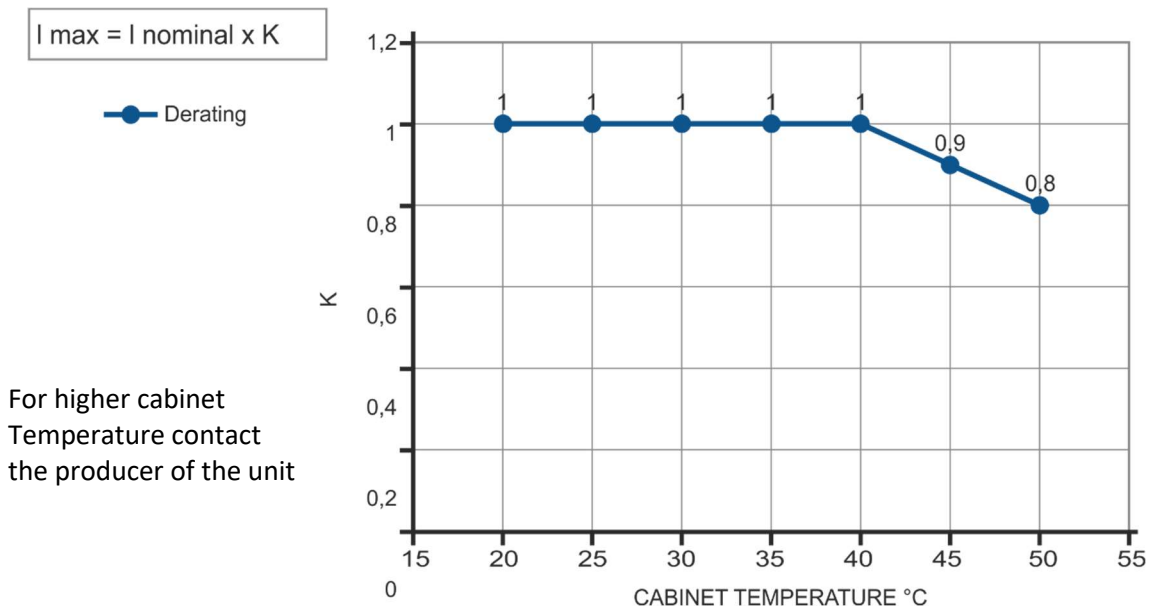

6.7. Calculating flow capacity of the fan

All the thyristor units when are in conduction produces power loss that is dissipated inside cubicle in terms of heating. Due to this fact the internal temperature of cubicle is higher than ambient temperature. To be cooled the thyristor need of fresh air cooling and to do it is normally used a fan mounted on the front door or on the roof of the cabinet.

Procedure to size **Fan air mass flow (V)**: see power loss for each thyristor and fuse mounted indicated in the manual related to the current (Output feature and Internal fuse Chapter).

$V = f * \frac{Qv}{tc - ta}$	Qv = total power losses (w) (thyristor + fuse power loss)	Altitude 0:100 meters f = 3,1 m³K/Wh 100:250 meters f = 3,2 m³K/Wh 250:500 meters f = 3,3 m³K/Wh 500:750 meters f = 3,4 m³K/Wh
	ta = ambient temperature (°C) tc = cabinet temperature (°C) V = fan air mass flow (m³/h) f = altitude coefficient (see table on right)	

The formulas used are for information only and is not a substitute for a proper thermal rating done by a qualified person

7. Installation

Before to install, make sure that the Thyristor unit have not damages.

If the product has a fault, please contact the dealer from which you purchased the product. Verify that the product is the same thing as ordered.

The Thyristor unit must be always mounted in vertical position to improve air cooling on heat-sink.

Maintain the minimum distances (*) in vertical and in horizontal as represented, this area must be free from obstacle (wire, copper bar, plastic channel).

When more unit has mounted inside the cabinet maintain the air circulation like represented in figure without obstacle for the air flow. Is necessary to install a fan to have better air circulation as calculated previously.

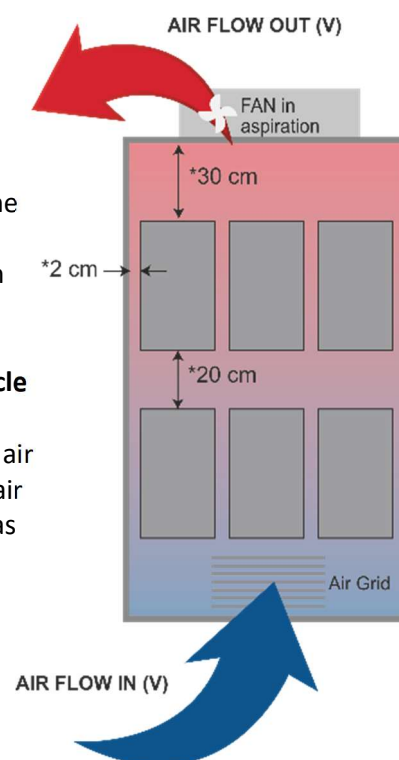

The V Air flow must be equal or more than the value calculated.
If the cabinet fan mounted by the customer have an air flow lower than the correct value the warranty will decay.

7.1. Dimensions and weight



Relay S 1PH	Width	Height	Depth	Weight
300A – 700A (S12)	137 mm	520 mm	270 mm	15 kg
800A (S15)	137 mm	560 mm	270 mm	15 kg

7.2. Fixing holes

Relay S 1PH 300A – 700A (S12)

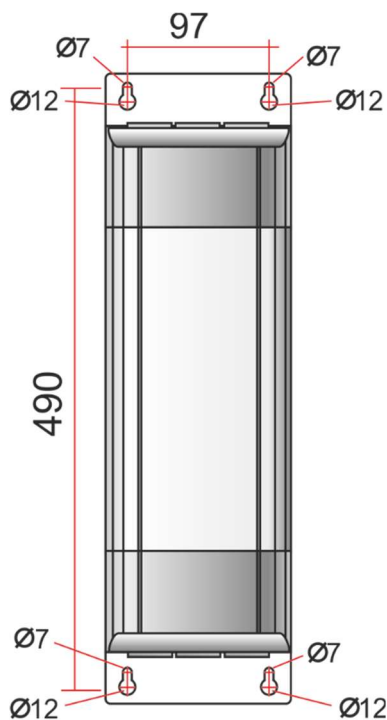

Relay S 1PH 800A (S15)

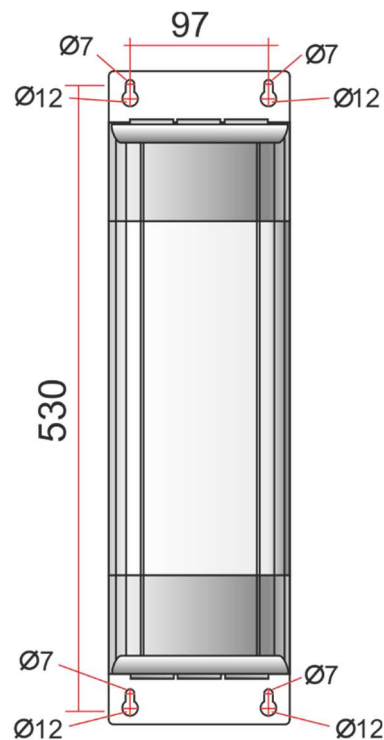

8. Wiring instructions

The Thyristor unit could be susceptible to interferences lost by near equipments or by the power supply, for this reason in accord to the fundamental practices rules is opportune take some precautions:

- The coil contactor, the relays and other inductive loads must be equipped with opportune RC filter.
- Use shielded bipolar cables for all the input and output signals.
- The signal cables must not be near and parallel to the power cables.
- Local regulations regarding electrical installation should be rigidly observed.

Use copper cables and wires rated for use at 75°C only.

8.1. Removing the cover

Instructions for open the thyristor unit



8.2. Line power and Load cable/bar dimensions and torque (suggested)

Current	Connector Type	Torque		Cable			Cable Terminal	Bar
		Lb-in	Nm	AWG	mm ²	kcmil		
300A (S12)	Power field wiring Bus Bar with M10 screw	265	30.0	2x1/0	2x70	350	UL Listed (ZMVV) Copper Tube Crimp. Lug	30x5 mm
400A (S12)				2x3/0	2x95	600		66x4 mm
500A (S12)				-	2x150	2x250 900		66x6 mm
600A (S12)				-	2x185	2x350 1500		66x6 mm
700A (S12)				-	2x300	2x500		66x6 mm
800A (S15)				-	2x300	2x500		66x6 mm

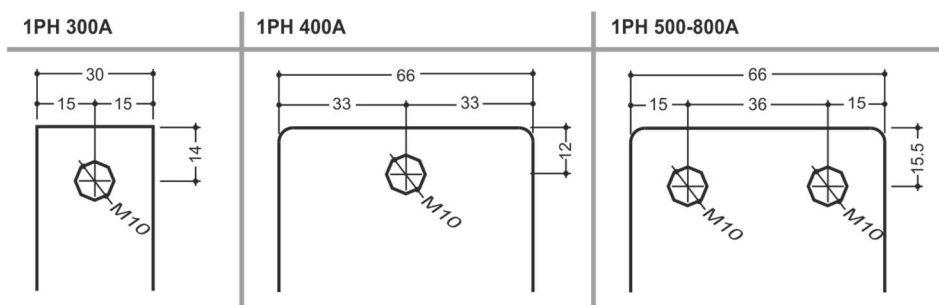

8.3. Cable dimensions (suggested) of Earth and of the Command Terminals

Current	Earth			Command Terminals	
	Cable		Schraube	Cable	
	mm ²	AWG		mm ²	AWG
300A (S12)	50	1	M8	0,50	18
400A (S12)	50	1	M8	0,50	18
500A (S12)	70	1/0	M8	0,50	18
600A (S12)	70	1/0	M8	0,50	18
700A (S12)	70	1/0	M8	0,50	18
800A (S15)	70	1/0	M8	0,50	18

8.4. Terminals Positions



Warning: Before connecting or disconnecting the unit check that power and control cables are isolated from voltage sources.

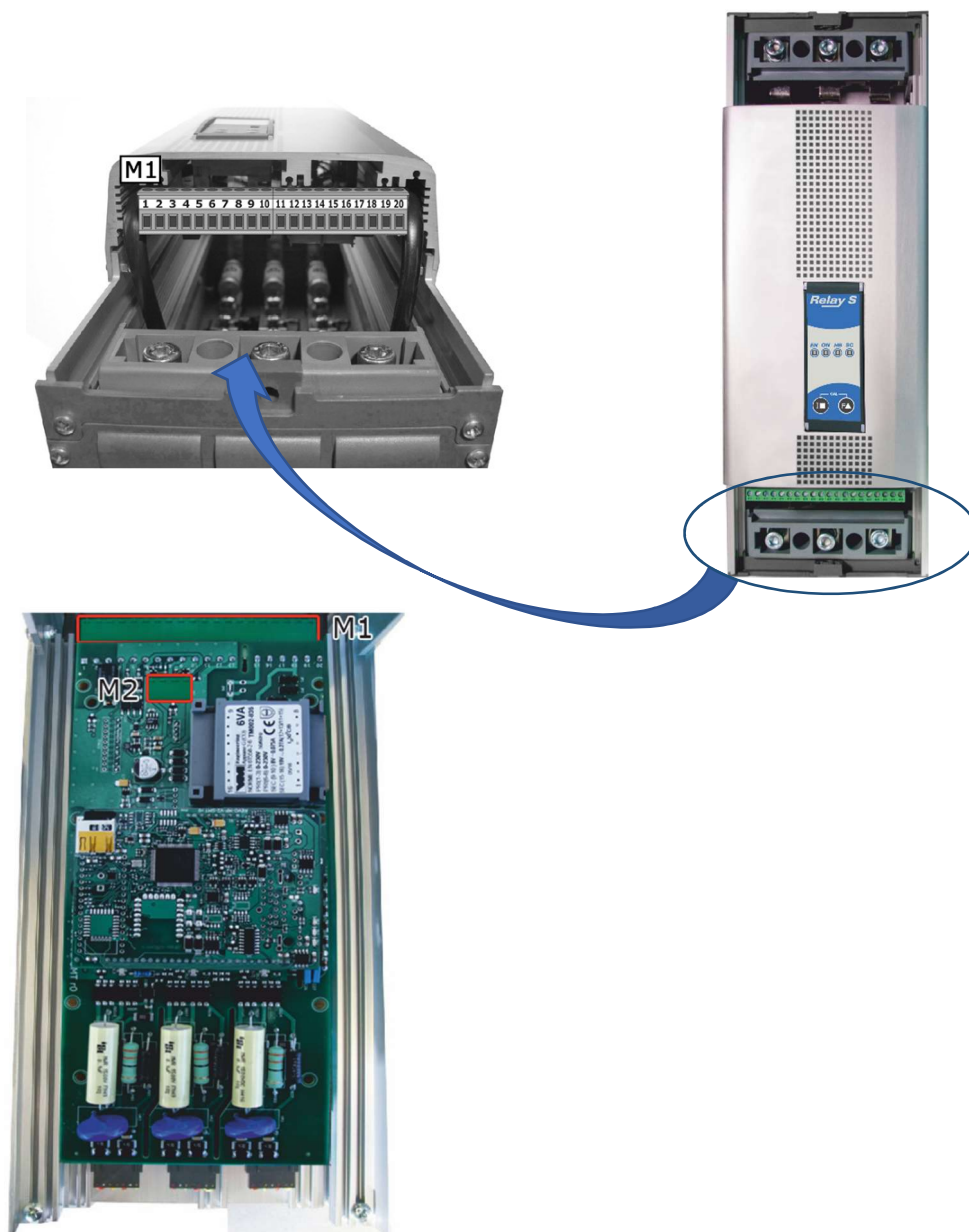

8.5. Power Terminals

300A – 800A (S12-S15)



Terminal	Description
L1	Line Input Phase 1
T1	Load Output Phase 1

8.6. Control Terminals



Warning: Before connecting or disconnecting the unit check that power and control cables are isolated from voltage sources.

8.6.1. terminal block M1

Terminal M1	Description
1	NO - Normally Open contact alarm relay output (Thermal or SC/HB/CL)
2	C - Common contact alarm relay output
3	NC - Normally Close contact alarm relay output (Thermal or SC/HB/CL)
4	Not Connected
5	DI 2 – Enable Digital Input
6	DI 1 - Configurable Input
7	Not Connected
8	Not Connected
9	Output +10Vdc stabilized 1 mA MAX
10	0V GND

Terminal M1	Description
11	- Analog Input 1 (0-10Vdc/4-20mA Analog Setpoint)
12	+ Analog Input 1 (0-10Vdc/4-20mA Analog Setpoint)
13	COM I - Common Digital Input
14	Not Connected
15	Fan supply (230V Standard – 115 Option - for DC Fan Option +24Vdc)
16	Fan supply (230V Standard – 115 Option - for DC Fan Option -24Vdc)
17	Not Connected
18	Aux – Voltage Supply for electronic boards and synchronization (See order code for the Value)
19	Not Connected
20	Aux – Voltage Supply for electronic boards and synchronization (See order code for the Value)

8.6.2. terminal block M2

Terminal M2	Description
1	24V Out Max 5mA
2	Slave Output
3	Not Connected
4	0V GND

8.7. Schematic



Caution: this procedure must be performed only by qualified persons.

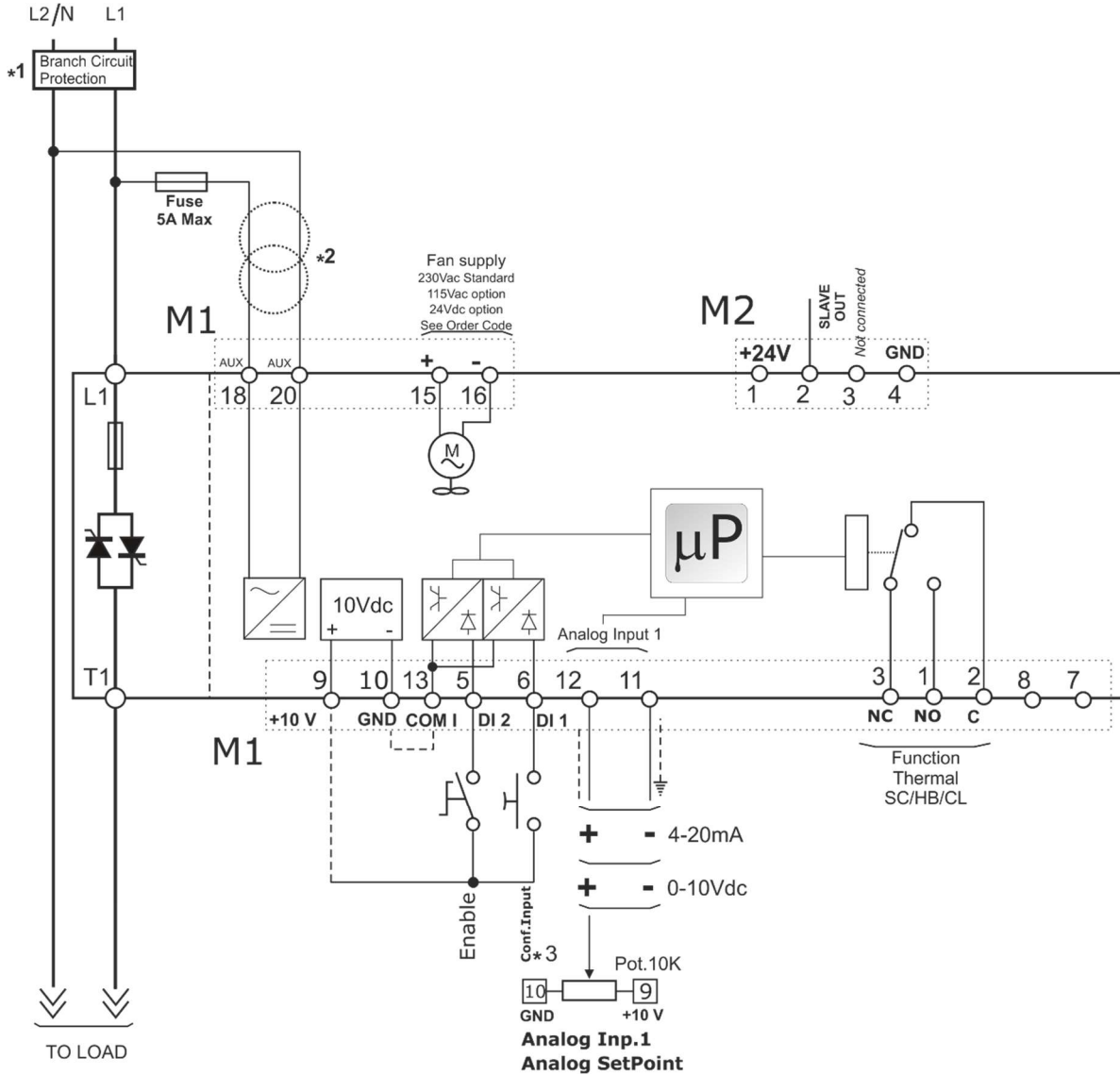

Note:

- *1 The user installation must be protecting by electromagnetic circuit breaker or by fuse isolator. The Fuse must be branch circuit protection. For UL any listed UL branch circuit fuse would be acceptable as an external fuse, following national electric code guide for resistive heating of 125% load current rating to protect external wires.
- *2 The auxiliary voltage supply of the Relay S unit must be synchronized with load voltage power supply. If the Auxiliary Voltage (written on the identification label) is different from Supply Voltage (to the load), use an external transformer as designated.
- *3 For SSR input connection follow next page schematic.

8.7.1. SSR Control Input schematic

For SSR input use follow the schematic below and configure Digital Input 1 as Fast Enable.

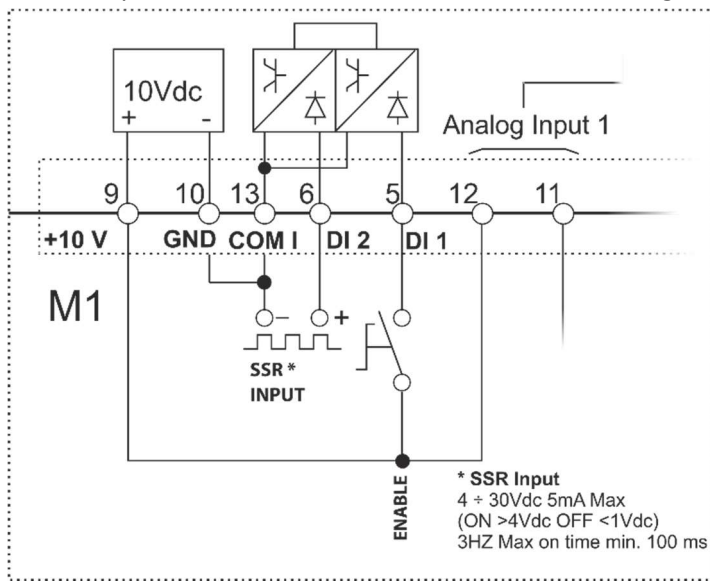

8.8. Connection Diagram for Single-phase



Caution: this procedure must be performed only by qualified persons.

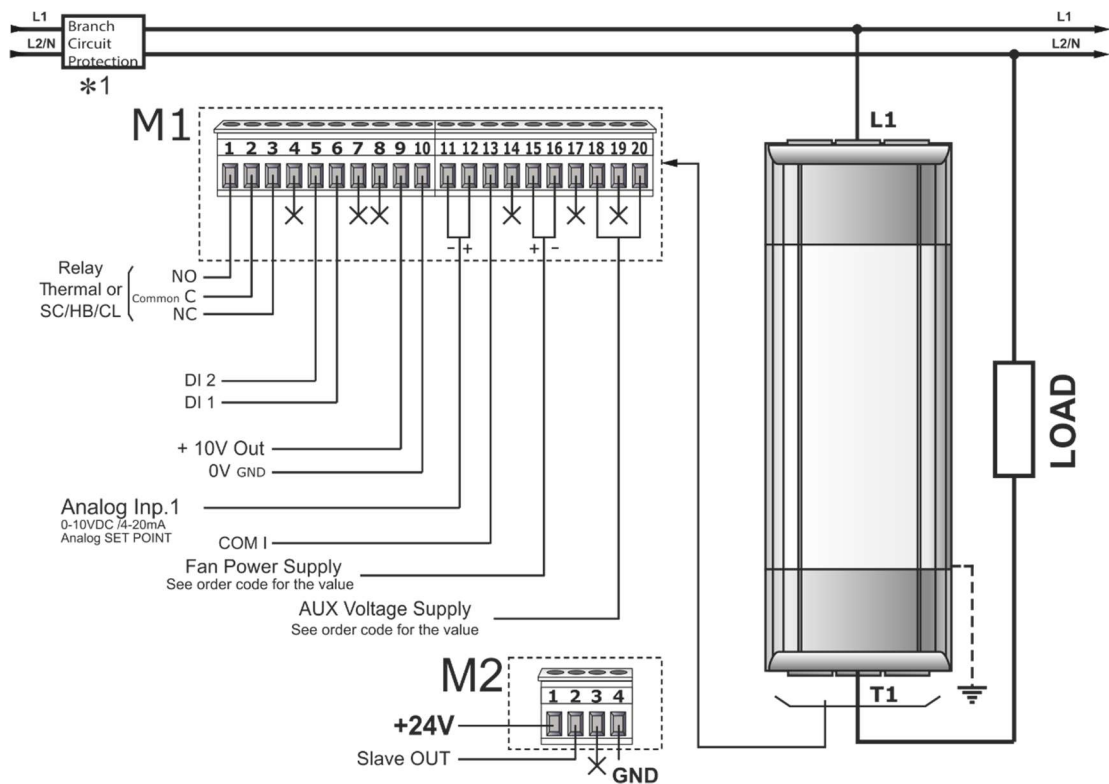









Note: Aux Voltage and Load Voltage must be synchronized

X = not connected

*1 The user installation must be protecting by electromagnetic circuit breaker or by fuse isolator. The Fuse must be branch circuit protection. For UL any listed UL branch circuit fuse would be acceptable as an external fuse, following national electric code guide for resistive heating of 125% load current rating to protect external wires.

8.9. Led status and alarms

LED	Status	Beschreibung
EN	LED Flashing 	Waiting for Enable Signal
	LED ON 	Enable Signal to terminal
ON	LED OFF 	Load is NOT powered
	LED ON 	Load is powered
SC	LED OFF 	Load OK
	LED ON 	SCR short circuit (only with HB option)
	LED Flashing 	Enable contact open or Over temperature on heat sink
HB	LED OFF 	Load OK
	LED ON 	Load Fault (only with HB option)

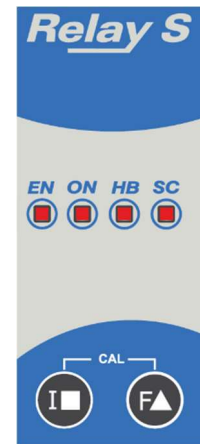

Input type informations

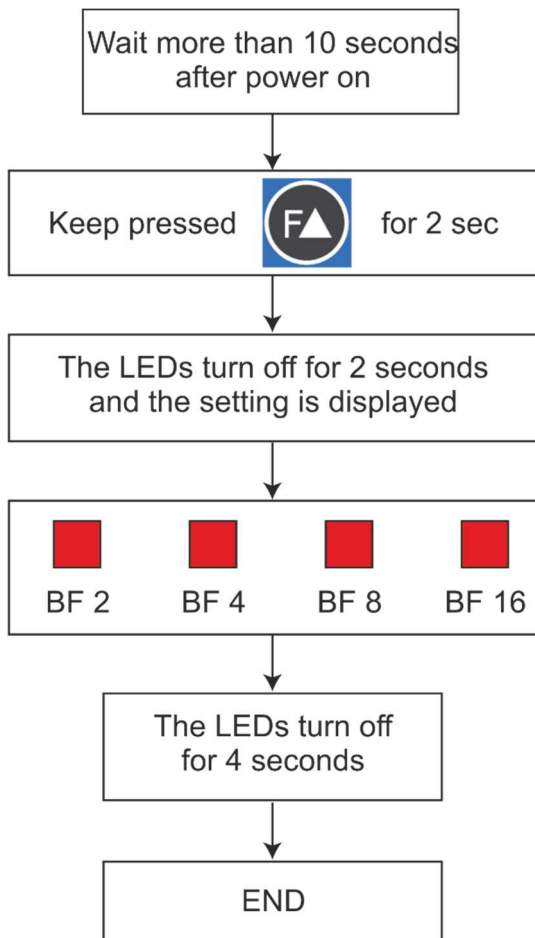

Burst Firing informations

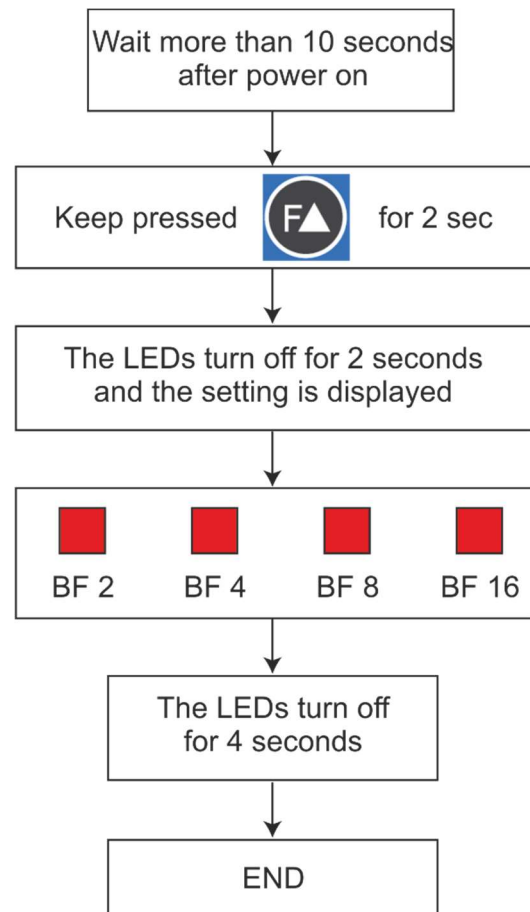

9. Heater Break alarm and SCR short circuit (HB Option only)





Caution: to work properly the load must be powered at least about 160msec.

The Heater Break circuit read the load current with an Internal current transformer (C.T.).
Minimum current is 10% of the current transformer size.
If load current is below this value the Heater Break Alarm doesn't work properly.

9.1. Heater break Calibration procedure

An automatic function sets the Heater Break Alarm.

The auto setting function can be activated by pressing the keys  +  simultaneously for 4 seconds.

The Heater Break calibration procedure is performed in this way:

- The Unit gives the maximum voltage output
- The leds light up in sequence until the procedure is completed
- The current and voltage value is stored in memory
- After about 15 second the unit comes back to the initial situation

If load resistance increase more than 20% (sensitivity 20%) the HB LED become ON and alarm relay change status.

If the unit is still in conduction with no input signal (ON LED OFF) it means that there is a short circuit on thyristors and SC LED become ON.

If the load has been changed the Heater Break calibration procedure must be done again.

The HB Alarm is detected with minimum ON time 100 ms

10. Input Setting

The Input type is already configured in line with customer requirements that are defined in the order code.

However, if you need to make changes you must follow the following procedure.

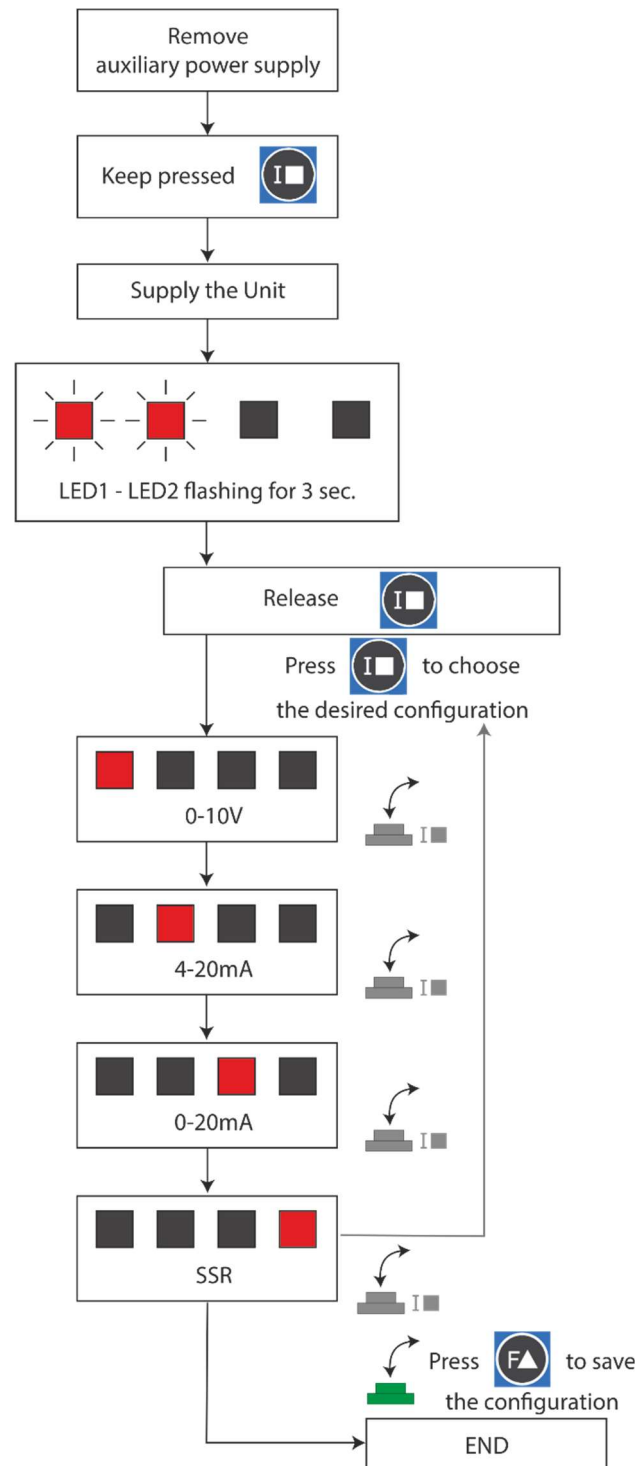

11. Burst Firing settings

The Burst Firing cycles is already configured in line with customer requirements that are defined in the Order Code. However, if you wish to change the Burst Firing cycles (es. from 4 to 8) you must follow the following procedure.

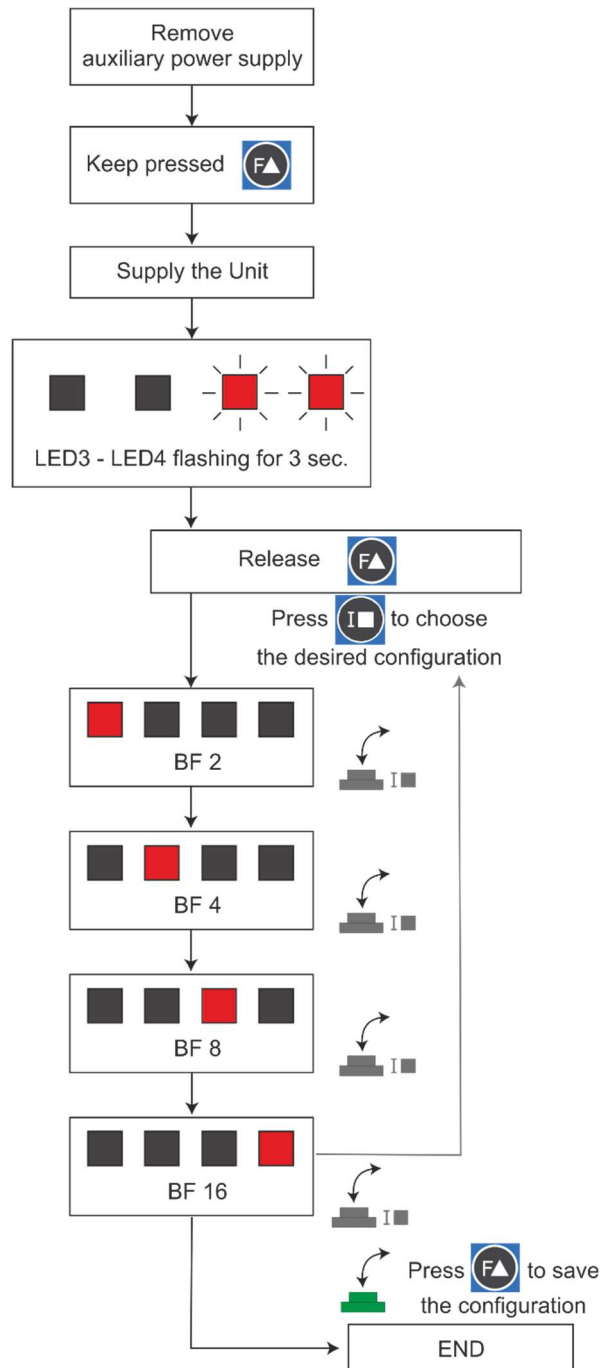

12. Firing type

Choose a correct firing type allows to optimize the thyristor unit for the installed load.

The firing type has already configured in line with customer requirements, Zero Crossing for SSR input and Burst firing for Analog Input.



Caution: this procedure must be performed only by qualified persons.

12.1. Zero Crossing (for SSR Input only)

ZC firing mode is used with Logic Output from temperature controllers and the Thyristor operates like a contactor.

The Cycle time is performed by temperature controller. ZC minimizes interferences because the Thyristor unit switches ON-OFF at zero voltage.

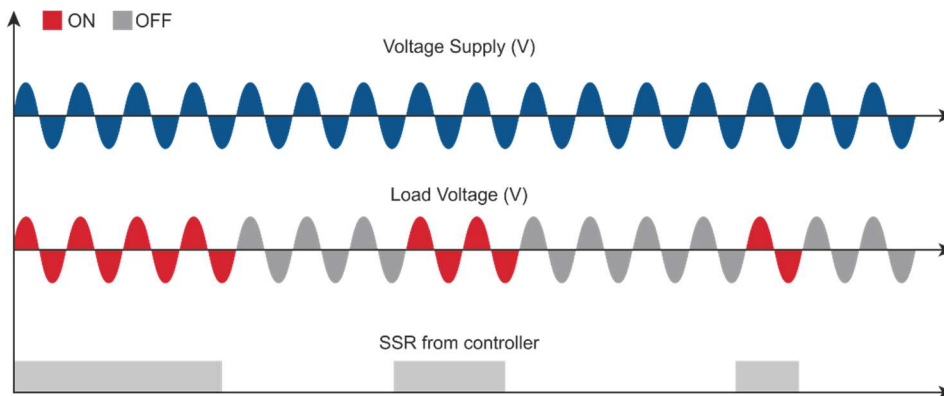

12.2. Burst Firing (for Analog Input option only)

The Burst Firing is similar to the Single Cycle, but consecutive cycles ON are selectable between 1 and 255, with input signal equal at 50%. When is specified 1 the firing type is Single Cycle.

Burst Firing is a method zero crossing that it reduces the electromagnetic interferences because the thyristor switches at zero voltage crossing.

The example show the Burst Firing with Burst cycles: 4.

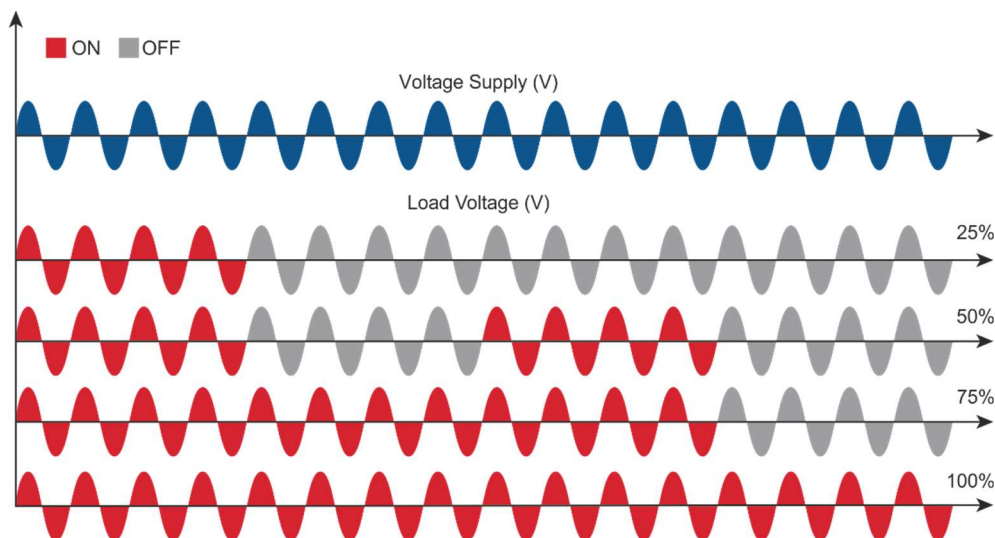

13. Supply the electronic board

The Relay S thyristor unit, to work, requires a voltage supply for the electronic boards. The Max consumption is 8VA. The voltage supply for the electronic boards is configured in line with customer requirements that are defined in the Order Code. The Order Code is written on the identification label.



Warning: Before connecting or disconnecting the unit check that power and control cables are isolated from voltage sources.

Terminal M1	Description
18	Voltage Supply for Electronic Boards (Auxiliary Voltage)
19	Not Used
20	Voltage Supply for Electronic Boards (Auxiliary Voltage)

To change auxiliary supply voltage sold the correct link-jumper on Relay S board, the type of mounted transformer depends of the chosen Voltage in the order code.

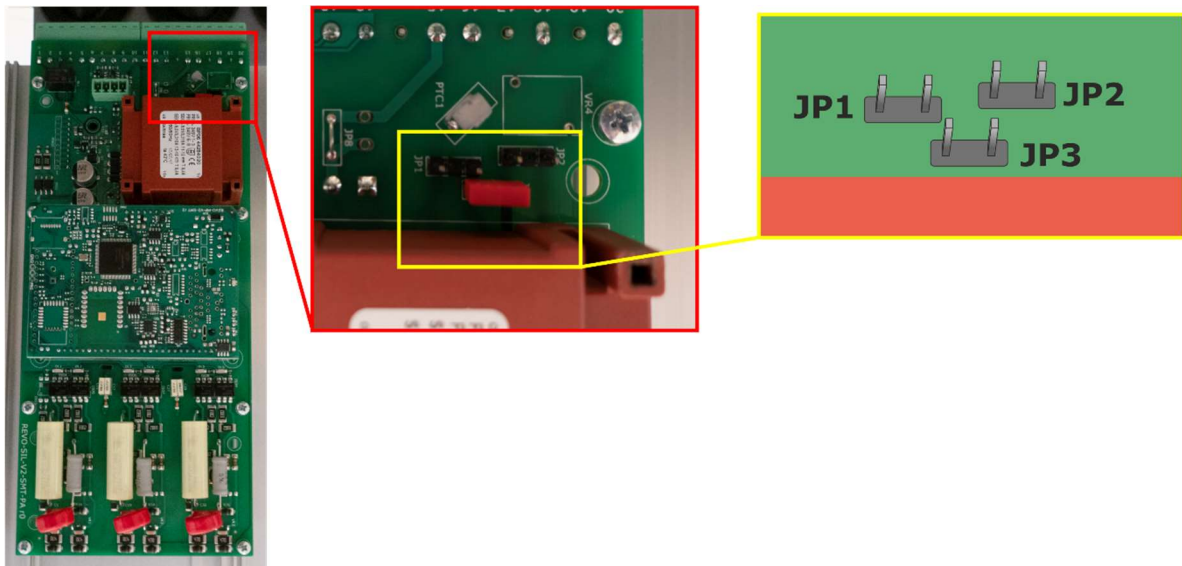

Order Code	As ordered		Change in	
	Jumper JP1 und JP2 gesteckt		Link only Jumper JP3	
	Transformer range	Line voltage	Transformer range	Line voltage
RC1_ - 1...	90...135V	100/120V	180...265V	200/208/220/230/240V
RC1_ - 2...	180...265V	200/208/220/230/240V	342...528V	380/400/415/440/480V
RC1_ - 3...	238...330V	277V	540...759V	600/690V
	Only Jumper JP3 is linked		Link Jumper JP1 and JP2	
RC1_ - 5...	342...528V	380/400/415/440/480V	180...265V	200/208/220/230/240V
RC1_ - 6...	540...759V	600V	238...330V	277V
RC1_ - 7...	540...759V	690V	238...330V	277V

If the Auxiliary Voltage (written on the identification label) is different from Supply Voltage (to the load), use an external transformer with primary equal to load voltage and secondary equal to the Auxiliary Voltage.

Attention! never link all the jumpers JP1+JP2+JP3 at the same time or JP3 + any other jumper, JP3 must be always alone, follow only the configuration shown.

14. Internal Fuse

The thyristor unit have internal fuse extrarapid at low I²t for the thyristor protection of against the short-circuits. The Fuses must have I²t 20% less than thyristor’s I²t. The warranty of thyristor is null if no proper fuses are used.

Size	200 kA RMS Symmetrical A.I.C.					Qty
	Fuse CODE	Current (A RMS)	FUSE I ² T value Suggested A ² s (at500V)*	FUSE I ² T value Suggested A ² s (at660V)	Vac	
300A (S12)	FM350	350	73500	105000	660	1
400A (S12)	FMM550	550	150500	215000	660	1
500A (S12)	FMM700	700	294000	420000	660	1
600A (S12)	4 x 20 559 20.250	4 x 250	246400	352000	660	1
700A (S12)	4 x 20 559 20.250	4 x 250	246400	352000	660	1
800A (S15)	4 x 20 559 20.250	4 x 250	246400	352000	660	1

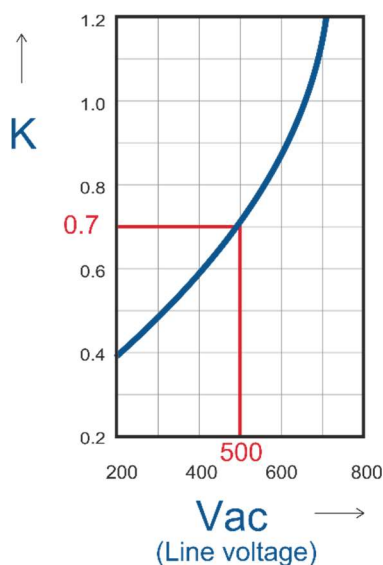

* I²T are multiplied for K value in function of Vac at 500V K is equal to 0.7 (ex: 105000 X 0,7 = 73500). At 660 Vac K is equal to 1.

Fuses replacement: Open the cover and remove the screws, then replace it with the correct fuse, use the screws with a proper suggested torque indicated below

Type	Screw	Torque Lb-in (N-m)
300-800A	M8	133.7(15.0)



Caution: High speed fuses are used only for the thyristor protection and can not be used to protect the installation.



Caution: The warranty of thyristor is null if no proper fuses are used. See tab.



Warning: When it is supply, the Thyristor unit is subject to dangerous voltage, don't open the Fuse-holder module and don't touch the electric equipments.

14.1. Fuses Replacement

Open the cover and remove the screws.

