



KS 98-1 Multifunction-unit operating manual



A publication of:



PMA

Prozeß- und Maschinen-Automation GmbH
P.O.Box 310 229 • D-34058 Kassel • Germany

All rights reserved.

No part of this document may be reproduced or published in any form or by any means without prior written permission from the copyright owner.

Symbols used on the device

 EU conformity mark



Attention, follow the operating instructions!

Symbols in the text



Danger of injury



Danger for the instrument, or of faulty function



Danger of destroying electronic components due to electrostatic discharge (ESD)



Additional information or reference to further sources of information.



Important hint for avoiding frequent operator faults.

Liability and warranty

Any information and notes in these operating instructions were composed under consideration of the applicable regulations, the present state of the art and our extensive know-how and experience.

With special versions, additional ordering options or due to the latest technical modifications, the actual scope of delivery may vary from the descriptions and drawings in this manual. For questions, please, contact the manufacturer.



Before starting to work with the instrument and before commissioning, in particular, these operating instructions must be read carefully! The manufacturer cannot be held responsible for damage and trouble resulting from failure to comply with the information given in this manual.

This product may be subject to change due to improvements of the product features in the course of further development.

Copyright

This operating manual should be considered as confidential information, intended only for persons who work with the instrument.

Contraventions are subject to payment of damages. Further claims reserved.

Content

1. Preface	4	8. Commissioning	26
2. Description	5	9. Operation	27
3. Safety notes	6	9.1 Front view	27
3.1 General	6	9.2 Menu structure	28
3.2 Correct use for intended application	6	9.3 Navigation, page selection	29
3.3 User responsibility	6	9.4 Adjusting values.	30
3.4 Instrument Safety.	6	10. Instrument settings	31
3.5 Unpacking the instrument	7	10.1 CAN-Status	31
3.6 Mounting	7	10.2 Profibus-Status	31
3.7 Electrical connections	7	10.3 ModC-Status.	31
3.8 Electrical safety.	7	10.4 Calibration	32
3.9 Commissioning	7	10.5 Online/Offline	32
3.10 Operation	8	11. Operating pages	33
3.11 Shut- down	8	11.1 List display	33
3.12 Maintenance and modification	8	11.2 Bargraph display	33
3.13 Explosion protection	8	11.3 Alarm display	33
4. Technical data	9	11.4 Graphic trend curve.	34
4.1 General	9	11.5 Programmer	34
4.2 Environmental conditions	9	11.6 Controller.	38
4.3 Connections	10	11.7 Cascade controller	43
4.4 Inputs.	10	12. Maintenance, test, trouble shooting	45
4.5 Outputs.	11	12.1 Cleaning	45
4.6 Modular Option C	12	12.2 Behaviour in case of trouble	45
4.7 CAN I/O extension.	14	12.3 Shut-down	45
4.8 Power supply	14	12.4 Test engineering as basic equipment	45
4.9 Bus interface (Option B)	15	12.5 I/O-Test.	47
4.10 Electromagnetic compatibility	15		
5. Versions	16		
5.1 I/O-Modules	17		
5.2 Ex-factory setting	17		
5.3 Auxiliary equipment.	17		
6. Mounting	18		
6.1 Function of wire-hook switches	19		
6.2 Retro-fitting and modific. of I/O-ext.	20		
6.3 I/O extension with CANopen	20		
7. Electrical connections	21		
7.1 Safety hints	21		
7.2 Electromagnetic compatibility	21		
7.3 Measurement earth connection	21		
7.4 RC protective circuitry	21		
7.5 Galvanic isolations	22		
7.6 General connecting diagram	22		
7.7 Analog inputs	24		
7.8 Digital in- and outputs.	25		
7.9 Connecting diagram i/o-modules.	25		

1. Preface

This installation manual provides the required information for identification, mounting, connection and electrical commissioning of the unit under consideration of safety notes of the application and environmental conditions.

Controls and indicators, menu structure and navigation with the cursor, selection of sub-menus and properties as well as adjustment of e.g. set-points and parameters are shown schematically.

 For functional commissioning, additional descriptions are required; please, order them separately or load them from the PMA homepage: www.pma-online.de



Note

As the functions provided in KS 98-1 are composed individually for each application using an Engineering Tool ET/KS 98, entire comprehension of the operating functions requires the relevant Project description with the Engineering !

Supplementary documentation:

Manual (GB)	9 4 9 9 - 0 4 0 - 8 2 7 1 1
PROFIBUS-protocol (GB)	9 4 9 9 - 0 4 0 - 8 2 8 1 1
ISO 1745-protocol (GB)	9 4 9 9 - 0 4 0 - 8 2 9 1 1

2. Description

The instrument is a compact automation unit the function of which can be configured freely by means of function blocks. Each unit contains a comprehensive function library for selection, configuration, parameter setting and connection of max. 450 function blocks by means of an engineering tool.

I.e. complex mathematical calculations, multi-channel control structures and sequence controllers can be realized in a single unit.

Various operating pages are indicated via the front-panel LCD matrix display, e.g.

- Numeric input and output of analog and digital signals, values and parameters as well as
- full-graphics display of bargraphs, controllers, programmers and trends.
- Display colour red / green and direct / inverse display can be switched over dependent on event, or by operation dependent on the engineering.

Dependent on version, the basic unit is equipped with analog and digital inputs, outputs and relays.

Additional inputs and outputs are available either with option C or "modular option C", which contains four sockets for various I/O modules.

Optionally, the unit may be equipped with 2 additional communication interfaces:

- Option B: serial TTL/RS422 interface or Profibus-DP
- Option CAN: CANopen-compliant interface port for the I/O extension with modular I/O system RM200

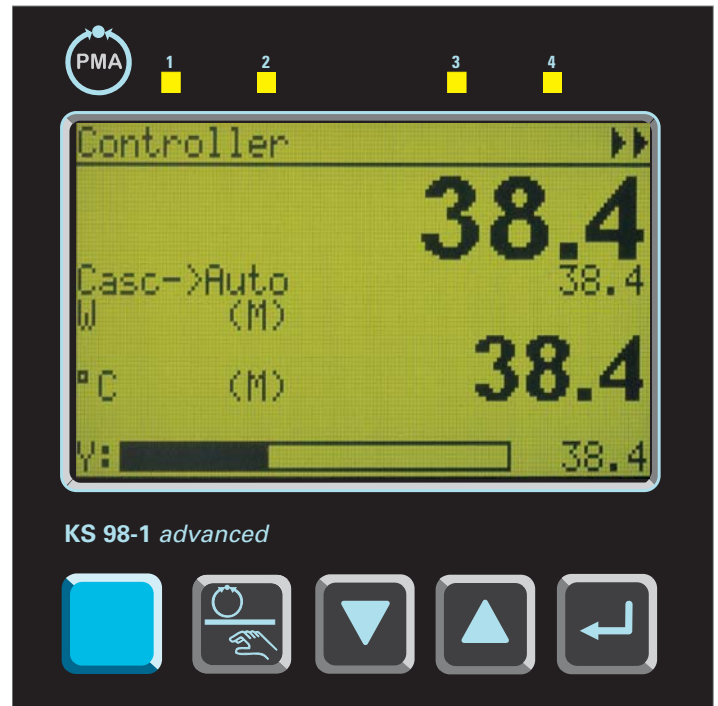

Fig. 1 Frontview

3. Safety notes

This section provides a survey of all important safety aspects: optimum protection of personnel and safe, trouble-free operation of the instrument.

Additionally, the individual chapters include specific safety notes for prevention of immediate hazards, which are marked with symbols. Moreover, the hints and warnings given on labels and inscriptions on the instruments must be followed and kept in readable condition continuously.

3.1 General

Software and hardware are programmed or developed in compliance with the state of the art applicable at the time of development, and considered as safe.

Before starting to work, any person in charge of work at the product must have read and understood the operating instructions.

The user is recommended to request evidence for knowledge of the operating instructions by the personnel.

3.2 Correct use for intended application

The operating safety is only ensured when using the products correctly for the intended application. The instrument can be used as a multiple function controller for open and closed control loops in industrial areas within the limits of the specified technical data and environmental conditions.

Any application beyond these limits is prohibited and considered as non-compliant.

Claims of any kind against the manufacturer and /or his lawful agents, for damage resulting from non-compliant use of the instrument are precluded, liability is limited to the user.

3.3 User responsibility

The user is responsible:

- for keeping the operating manual in the immediate vicinity of the instrument and always accessible for the operating personnel.
- for using the instrument only in technically perfect and safe condition.

Apart from the work safety notes given in these operating instructions, compliance with the generally applicable regulations for safety, accident prevention and environment protection is compulsory.

The user and the personnel authorized by the user are responsible for perfect functioning of the instrument and for clear definition of competences related to instrument operation and maintenance. The information in the operating manual must be followed completely and without restrictions!

The user is responsible that the instrument is operated only by trained and authorized persons. Maintenance and repair may be done only by trained and specialized persons who are familiar with the related hazards.

Operation and maintenance of the instrument are limited to reliable persons. Any acts susceptible to impair the safety of persons or of the environment have to be omitted. Any persons who are under effect of drugs, alcohol or medication affecting reaction are precluded from operation of the instrument.

3.4 Instrument Safety

This instrument was built and tested according to VDE 0411 / EN61010-1 and was shipped in safe condition. The unit was tested before delivery and has passed the tests required in the test plan.

In order to maintain this condition and to ensure safe operation, the user must follow the hints and warnings given in these safety notes and operating instructions.

The unit is intended exclusively for use as a measuring and control instrument in technical installations.

The insulation meets standard EN 61010-1 with the values for overvoltage category, degree of contamination, operating voltage range and protection class specified in the operating instructions / data sheet.

The instrument may be operated within the specified environmental conditions (see data sheet) without impairing its safety.

The instrument is intended for mounting in an enclosure. Its contact safety is ensured by installation in a housing or switch cabinet.

3.5 Unpacking the instrument

Remove instrument and accessories from the packing. Enclosed standard accessories:

Operating notes or operating instructions for the instrument (if necessary, fixing elements).

Check, if the shipment is correct and complete and if the instrument was damaged by improper handling during transport and storage.



WARNING!

If the instrument is so heavily damaged that safe operation seems impossible, the instrument must not be taken into operation.

We recommend to keep the original packing for shipment in case of maintenance or repair.

3.6 Mounting

Mounting is done in dustfree and dry rooms.

The sealing devices (e.g. sealing ring) required for the relevant protection type must also be fitted.

3.7 Electrical connections

All electrical wiring must conform to local standards (e.g. VDE 0100 in Germany).

The input leads must be kept separate from signal and mains leads.

The protective earth must be connected to the relevant terminal (in the instrument carrier).

The cable screening must be connected to the terminal for grounded measurement. In order to prevent stray electric interference, we recommend using twisted and screened input leads.

The electrical connections must be made according to the relevant connecting diagrams.

3.8 Electrical safety

The insulation of the instrument meets standard EN 61 010-1 (VDE 0411-1) with contamination degree 2, overvoltage category III, working voltage 300 V r.m.s. and protection class I.

Galvanically isolated connection groups are marked by lines in the connecting diagram.

3.9 Commissioning

Before instrument switch-on, ensure that the rules given below were followed:

- Ensure that the supply voltage corresponds to the specification on the type label.
- All covers required for contact safety must be fitted.
- Before instrument switch-on, check if other equipment and / or facilities connected in the same signal loop is / are not affected. If necessary, appropriate measures must be taken.
- On instruments with protection class I, the protective earth must be connected conductively with the relevant terminal in the instrument carrier.
- The instrument must be operated only when mounted in its enclosure.

3.10 Operation

Switch on the supply voltage. The instrument is now ready for operation. If necessary, a warm-up time of approx. 1.5 min. should be taken into account.



Warning !

Any interruption of the protective earth in the instrument carrier can impair the instrument safety. Purposeful interruption is not permissible.

If the instrument is damaged to an extent that safe operation seems impossible, shut it down and protect it against accidental operation.

3.11 Shut- down

For permanent shut- down, disconnect the instrument from all voltage sources and protect it against accidental operation.

Before instrument switch- off, check that other equipment and / or facilities connected in the same signal loop is / are not affected. If necessary, appropriate measures must be taken.

3.12 Maintenance and modification

The instrument needs no particular maintenance. Modifications, maintenance and repair may be carried out only by trained, authorized persons. For this, the user is invited to contact the service.

For correct adjustment of wire-hook switches (page) and for installation of modular option C, the unit must be withdrawn from the housing.



Warning!

When opening the instruments, or when removing covers or components, live parts or terminals can be exposed.

Before carrying out such work, the instrument must be disconnected from all voltage sources.

After completing such work, re- shut the instrument and re-fit all covers and components. Check, if the specifications on the type label are still correct, and change them, if necessary.

3.13 Explosion protection

Non-intrinsically safe instruments must not be operated in explosion-hazarded areas. Moreover, the output and input circuits of the instrument / instrument carrier must not lead into explosion-hazarded areas.

4. Technical data

4.1 General

Housing

Plug-in module, inserted from front.

Material: Makrolon 9415, flame-retardant, self-extinguishing

Flammability class: UL 94 V0

Front-panel / display

160 x 80-dot LCD matrix display

4 LEDs, 4 foil-covered keys

Front interface port (standard)

Front-panel socket for PC adapter (see „Accessories“ page 17).

Protection mode

(to EN 60 529, DIN VDE 0470)

Front: IP 65

Housing: IP 20

Terminals: IP 00

Safety tests

To EN 61 010-1

- Overvoltage category: III
- Contamination class: 2
- Working voltage range: 300 VAC
Protection class: I

The unit meets the following European guidelines:

- Electromagnetic compatibility (EMC):
89/336/EEC (as amended by 93/97/EEC)
- Electrical apparatus (low-voltage guideline):
73/23/EEC (as amended by 93/68/EEC).

Evidence of conformity is provided by compliance with EN 61326-1 and EN 61010-1

DIN EN 14597

The device may be used as temperature control and limiting equipment according to DIN EN 14597.

CE marking

Meets the European Directives regarding „Electromagnetic Compatibility“ and „Low-voltage equipment“ (→ page 21)

cULus certification

(Type 1, indoor use) File: E 208286

Electrical connections

Screw terminals for conductor cross-section from 0,5 - 2,5 mm²

Mounting method

Panel mounting with 4 fixing clamps at top/bottom

Mounting position

Not critical

Weight

Approx. 0.75 kg with all options

4.2 Environmental conditions

Permissible temperatures

For operation: 0...50 °C

Storage and transport: -20...60 °C

Temperature effect: ≤ 0.15% / 10 K

Climatic category

KUF to DIN 40 040

Relative humidity: ≤ 75% yearly average, no condensation

Shock and vibration

Vibration test Fc

To DIN 68-2-6 (10...150 Hz)

Unit in operation: 1g or 0.075 mm,

Unit not in operation: 2g or 0.15 mm

Shock test Ea

To DIN IEC 68-2-27 (15g, 11 ms)

4.3 Connections

Depending on version and selected options, the following inputs and outputs are available:

	DI	DO	AI	AO
4 relays or 2 relays + 2 AO	di1* di2*	OUT1 OUT2 OUT4 OUT5	INP1 INP5 INP6	–
OPTION B	di3 di4 di5 di6 di7	do1 do2 do3 do4	–	–
OPTION C* or modular OPTION C*	di8 di9 di10 di11 di12	do5 do6	INP3 INP4	OUT3
	Depending on module type			

* Not available with option CAN!

4.4 Inputs

Universal input INP1

Limiting frequency: $f_g = 1 \text{ Hz}$, Measurement cycle: 200 ms

Thermocouples

according to DIN IEC 584

Type	Range	Error	Resolution
L	-200...900°C	≤ 2K	0,05 K
J	-200...900°C	≤ 2 K	0,05 K
K	-200...1350°C	≤ 2 K	0,072 K
N	-200...1300°C	≤ 2 K	0,08 K
S	-50...1760°C	≤ 3 K	0,275 K
R	-50...1760°C	≤ 3 K	0,244 K
B 1)	(25)400...1820°C	≤ 3 K	0,132 K
T	-200.. .400°C	≤ 2 K	0,056 K
W(C)2)	0...2300°C	≤ 2 K	0,18 K
E	-200... 900°C	≤ 2 K	0,038 K

* 1) from 400 °C

* 2) W5Re/W26Re

With linearization (temperature-linear in °C or °F)

Input resistance: $\geq 1 \text{ M}\Omega$

Cold-junction compensation (CJC): built in

Input circuit monitor:

Current through sensor: $\leq 1 \text{ mA}$

Reverse-polarity monitor is triggered at 10 °C below span start.

Additional error of internal CJC

≤ 0.5 K per 10 K terminal temperature External temperature selectable: 0...60 °C or 32...140 °F

Resistance thermometer

Pt 100 to DIN IEC 751, and temperature difference 2 x Pt 100

Range	Error	Resolution
-200.0...250.0 °C	≤ 0.5 K	0.024 K
-200.0...850.0 °C	≤ 1.0 K	0.05 K
2 x -200.0...250.0 °C	≤ 0.5 K	0.024 K
2 x -200.0...250.0 °C	≤ 0.1 K	0.05 K

Linearization in °C or °F

Two or three-wire connection.

Two-wire connection with lead resistance adjustment.

Lead resistance: $\leq 30 \Omega$ per lead

Sensor current: $\leq 1 \text{ mA}$

Input circuit monitoring for sensor/lead break, and lead short circuit.

Potentiometric transducer

R_{total} incl. 2 x R_L	Error	Resolution
0...500 Ω	≤ 0.1 %	≤ 0.02 Ω

Resistance-linear

Sensor current: $\leq 1 \text{ mA}$

Matching/scaling with sensor connected.

Input circuit monitoring for sensor/lead break, and lead short circuit.

Resistance input

Range	Error	Resolution
0...250 Ω	$\leq 0.25 \Omega$	$< 0.01 \Omega$
0...500 Ω	$\leq 0.5 \Omega$	$< 0.02 \Omega$

Direct current 0/4...20mA

Range	Error	Resolution
0/4...20 mA	$\leq 0.1 \%$	$\leq 0.8 \text{ mA}$

Input resistance: 50 Ω

Input circuit monitor with 4...20mA: triggered when $I \leq 2 \text{ mA}$

Direct voltage

Range	Error	Resolution
0/2...10 V	$\leq 0.1 \%$	$\leq 0.4 \text{ mV}$

Input resistance $\geq 100 \text{ k}\Omega$

Signal input INP5**Differential amplifier input**

Up to 6 controllers can be cascaded, if there is no other galvanic connection between them. If there is, only 2 inputs can be cascaded.

Direct current and voltage

Technical data as for INP1, except for:

Limiting frequency: = 0.25 Hz

Measurement cycle: 800 ms

Input resistance (voltage): $\geq 500 \text{ k}\Omega$

Signal input INP6

Limiting frequency: = 0.5 Hz

Measurement cycle: 400 ms

Potentiometric transducer

Technical data as for INP1, except for:

R_{total} inkl. 2 x R_L	Error	Resolution
0...1000 Ω	$\leq 0.1 \%$	$\leq 0.04 \Omega$

Direct current 0/4...20 mA

Technical data as for INP1

Signal inputs INP3, INP4 (option C)

Galvanically-isolated differential amplifier inputs.

Measurement cycle: 100 ms

Direct current

Technical data as for INP1

except $R_i = 43 \Omega$

Control inputs di1...di12

di1, di2: standard

di3...d7: Option B

di8...di12: Option C

Opto-coupler

Nominal voltage: 24 VDC, external

Current sink (IEC 1131 Type 1)

Logic „0“ (Low): $-3...5 \text{ V}$

Logic „1“ (High): $15...30 \text{ V}$

Current demand: approx. 6 mA (for galvanic connections and isolation see page 22).

Built-in transmitter supply (optional)

Short-circuit proof.

Can be used to energize a two-wire transmitter or up to 4 opto-coupler inputs. Galvanically isolated.

Output: $\geq 17.5 \text{ VDC}$, max. 22 mA

Factory setting

The transmitter supply is available at terminals A12 and A14

 See page 23

4.5 Outputs**Outputs OUT1, OUT2, OUT4, OUT5**

Relay or current/logic signal, depending on version.

Relay outputs (OUT4, OUT5)

Relays have potential-free change-over contacts.

Max. contact rating:

500 VA, 250 V, 2 A with 48...62 Hz, $\cos\varphi \geq 0,9$

Minimum rating: 12 V, 10 mA AC/DC

Number of switching cycles electrical: for $I = 1A/2A$
 $\geq 800,000 / 500,000$ (at $\sim 250V$ / (resistive load))

! When connecting a contactor to a relay output, RC protective circuitry to specification of the contactor manufacturer is required. Varistor protection is not recommended!

OUT1, OUT2 as current outputs

Galvanically isolated from the inputs

0/4...20 mA, selectable

Signal range: 0...22 mA

Resolution: ≤ 6 mA (12 bits)

Error: $\leq 0.5\%$

Load: $\leq 600 \Omega$

Load effect: $\leq 0.1\%$

Limiting frequency: approx. 1 Hz Output cycle:
 100ms

OUT1, OUT2 as logic signal

0 / ≥ 20 mA with a load $\geq 600 \Omega$

0 / > 12 V with a load $\geq 600 \Omega$

Output OUT3 (Option C)

Technical data as for OUT1, OUT2

Control outputs do1..do6

Galvanic isolated Opto-coupler outputs, galvanic isolation see page 22.

Grounded load:

common positive control voltage

Switch rating: 18...32 VDC; $I_{max} \leq 70$ mA

Internal voltage drop: $\leq 0.7V$ with I_{max}

Protective circuit: thermal, switches off with overload.

Supply 24 V DC external

Residual ripple $\leq 5\%_{SS}$

4.6 Modular Option C

Each module has two channels which can be configured independently.

A/D-Converter

Resolution: 20,000 (50Hz) or 16,667 (60Hz) steps for the selected measuring range.

Conversion time: 20ms (50Hz) or 16.7ms (60Hz).

D/A-Converter

Resolution: 12 Bit

Refresh-Rate: 100 ms

Cut-off frequency

Analog: $f_g=10Hz$

Digital: $f_g=2Hz$

Measurement cycle: 100 ms per module

R_INP

Resistive input module

(9407-998-0x201)

Connection method: 2, 3 or 4-wire circuit (with 3 und 4-wire connection, only one channel can be used). Sensor current: $\leq 0,25mA$

Resistance thermometer

Type	Range °C	Overall error	Resolution K/Digit
Pt100	-200...850°C	≤ 2 K	0,071
Pt100	-200...100°C	≤ 2 K	0,022
Pt1000	-200...850°C	≤ 2 K	0,071
Pt1000	-200...100°C	≤ 2 K	0,022
Ni100	-60...180°C	≤ 2 K	0,039
Ni1000	-60...180°C	≤ 2 K	0,039

Linearization: in °C oder °F

Lead resistance

Pt (-200...850°C): $\leq 30 \Omega$ per lead

Pt (-200...100°C), Ni: $\leq 10 \Omega$ per lead

Lead resistance compensation

3 and 4-wire connection: not necessary.

2-wire connection: compensation via the front with short-circuited sensor. The calibration values are stored in a non-volatile memory.

Lead resistance effect

3 and 4-wire connection: negligible

Sensor monitoring

Break: sensor or lead. Short-circuit: triggers at 20 K below measuring range.

Resistance / Potentiometer

Range R_{ges} / Ω	Overall error	Resolution Ω /Digit
0...160 Ω	$\leq 1\%$	0,012
0...450 Ω	$\leq 1\%$	0,025
0...1600 Ω	$\leq 1\%$	0,089
0...4500 Ω	$\leq 1\%$	0,025

Characteristic: resistance-linear

Lead resistance or 0%/100% compensation: via the front with short-circuited sensor. The calibration values are stored in a non-volatile memory.

- Variable resistance (only 2-wire connection): calibration for 0%
- Potentiometer: calibration for 0% and 100%

Lead resistance effect

3 and 4-wire connection: negligible

Sensor monitoring: break: sensor or lead

TC_INP**Thermocouple, mV, mA Module**

(9407-998-0x211)

Thermocouples

To DIN IEC 60584 (except L, W/C, D)

Type	Range	Overall error	K/Digit
L	-200...900°C	≤ 2 K	0,080
J	-200...900°C	≤ 2 K	0,082
K	-200...1350°C	≤ 2 K	0,114
N	-200...1300°C	≤ 2 K	0,129
S	-50...1760°C	≤ 3 K	0,132
R	-50...1760°C	≤ 3 K	0,117
B ⁽¹⁾	(25) 400...1820°C	≤ 3 K	0,184
T	-200...400°C	≤ 2 K	0,031
W(C)	0...2300°C	≤ 2 K	0,277
D	0...2300°C	≤ 2 K	0,260
E	-200...900°C	≤ 2 K	0,063

* (1) Values apply from 400°C

Linearization: in °C or °F

Linearity error: negligible

Input resistance: $\geq 1M\Omega$

Temp. compensation (CJC): built in

Error: $\leq 0.5K/10K$

External CJC possible: 0...60 °C or. 32...140 °F

Source resistance effect: 1mV/k Ω

Sensor monitoring: Sensor current: $\leq 1\mu A$

Reversed polarity monitor: triggers at 10K below measuring range

mV input

Range	Overall error	Resolution
0...30 mV	≤ 45 mV	1,7 mV
0...100 mV	≤ 150 mV	5,6 mV
0...300 mV	≤ 450 mV	17 mV

Input resistance: $\geq 1M\Omega$

Break monitoring: built in. Sensor current: $\leq 1\mu A$

mA input

Range	Overall error	Resolution
0/4...20 mA	$\leq 40 \mu A$	2 μA

Input resistance: 10 Ω

Break monitor: <2mA (only for 4...20 mA)

Over range monitor: >22mA

U_INP**High-impedance voltage input**

(9407-998-0x221)

Range	Overall error	Resolution mV/Digit
-50...1500 mV	$\leq 1,5$ mV	0,09
0...10 V	≤ 10 mV	0,56

Characteristic: voltage-linear

Input resistance: >1G Ω

Source resistance effect: $\leq 0,25$ mV/M Ω

Sensor monitoring: none

U_OUT**Voltage output module**

(9407-998-0x301)

Signal ranges: 0/2...10V, -10...10V configurable

Resolution: approx.. 5.4 mV/digit

Load: ≥ 2 k Ω

Load effect: $\leq 0.1\%$

I_OUT

Current output module

(9407-998-0x311)

Signal ranges: 0/4...20mA, -20...20mA configurable

Resolution: ca. 11µA/Digit

Load: ≤ 400 Ω

Load effect: ≤ 0.1%/100Ω

DIDO

Digital I/O Module

(9407-998-0x401)

Number of channels: 2 (configurable as input or output by channel)

Input

Current sink: to IEC 1131 Type 1)

Logic „0“: -3...5V

Logic „1“: 15...30V

Measurement cycle: 100 ms

Galvanic isolation : via opto-couplers

Nominal voltage: 24 VDC external

Input resistance: 5 kΩ

Output

Grounded load (common positive control voltage)

Switch rating: 18...32 VDC; ≤70 mA

Internal voltage drop: ≤ 0.7 V

Refresh-Rate: 100 ms

Galvanic isolation : via opto-couplers

Protective circuit: thermal, switches off with overload.

F_INP

Frequency/counter Module

(9407-998-0x411)

Current sink: to IEC 1131 Type 1

Logic „0“: -3...5V

Logic „1“: 15...30V

Galvanic isolation: via Opto-couplers

Nominal voltage: 24 VDC external

Input resistance: 12 kΩ

Selectable functions:

- Control input (2 channels)
- Pulse counter (2 channels)
- Frequency counter (2 channels)
- Up/down counter (1 channel)
- Quadrature counter (1 channel)

Frequency range: ≤ 20 kHz

Signal shape: any (square 1:1 with 20kHz)

Gate time: 0.1...20s adjustable (only relevant with frequency measurement)

Influencing factors

Temperature effect: ≤ 0,1%/10K

Supply voltage: negligible

Common mode interference: negligible up to 50 Vrms

Series mode interference: negligible up to 300 mVrms (TC), 30 mVrms (RT), 10 Vrms (U), 5 Vrms (F)

4.7 CAN I/O extension

The unit offers a port conforming to CANopen for connection of the RM 200 system and of KS 800 or additional KS 98-1 units with max. five CAN nodes.

 Note: Control inputs di1 and di2 are not available !

 Modular option C is not available

4.8 Power supply

Dependent on version:

Alternating current

90...250 VAC

Frequency: 48...62 Hz

Power consumption: approx. 17 VA; 10 W (max. configuration).

Universal current 24 V UC

24 VAC, 48...62 Hz/24 VDC

Tolerance: +10...-15% AC 18...31.2 VDC

Power consumption

AC: approx. 14.1 VA; 9.5 Ω

DC: 9,1 W (max. configuration).

Behaviour after power failure

Storage in non-volatile EEPROM for structure, configuration, parameter setting and adjusted setpoints.

Storage in a capacitor-buffered RAM (typ. > 15 minutes) for data of time functions (programmers, integrators, counters, ...)

Real-time clock (Option B, RS 422)

Buffer capacitor provides back-up for at least 2 days (typical).

4.9 Bus interface (Option B)**TTL and RS422 / 485-interface**

Galvanically isolated, choice of TTL or RS 422/485 operation.

Number of controllers per bus:

With RS 422/485: 32

With TTL signals: 32 interface modules. address range ((00...99) See Documentation 9499-040-82911) .

PROFIBUS-DP interface

According to EN 50 170, Vol. 2.

Reading and writing of all process data, parameters, and configuration data.

Transmission speeds and cable lengths

automatic transm. speed detection, 9,6 kbit/s ...12 Mbit/s

Addresses

0...126 (factory setting: 126). Remote addressing is possible.

Other functions

Sync and Freeze

Terminating resistors

Internally selectable with wire-hook switches.

Cable

According to EN 50 170, Vol. 2 (DIN 19 245T3).

Required accessories

Engineering Set PROFIBUS-DP, consisting of:

- GSD file, Type file
- PROFIBUS manual
- Function block(s) for Simatic S5/S7

4.10 Electromagnetic compatibility

Complies with EN 50 081-2 and EN 50 082-2.

Electrostatic discharge

Test to IEC 801-2,

8 kV air discharge

4 kV contact discharge

High-frequency interference

Test to ENV 50 140 (IEC 801-3)

80...1,000 MHz, 10 V/m

Effect: $\leq 1\%$

HF interference on leads

Test to ENV 50141 (IEC 801-6)

0.15...80 MHz, 10 V

Effect: $\leq 1\%$

Fast pulse trains (burst)

Test to IEC 801-4

2 kV applied to leads for supply voltage, and signal leads. Effect: $\leq 5\%$ resp. restart

High-energy single pulses (surge)

Test to IEC 801-5

1 kV symmetric or 2 kV asymmetric on leads for supply voltage.

0.5 kV symmetric or 1 kV asymmetric on signal leads.

5. Versions

The instrument version results from the combination of various variants from the following table.

Please mind footnotes!
KS98-1 with screw terminals only!

		K	S	9	8	-	1			-			0			-		0	0
BASIC UNIT	KS 98 Standard						0												
	KS 98 with transmitter power supply						1												
	KS 98 with CANopen I/O ¹⁾						2												
POWER SUPPLY AND CONTROL OUTPUTS	90...250V, AC 4 relays						0												
	24V UC, 4 relays						1												
	90...250V AC, 2 relays+ 2 mA/logic						4												
	24V UC, 2 relays+ 2 mA/logic						5												
OPTION B INTERFACE	no interface											0							
	TTL interface + di/do											1							
	RS422 + di/do + clock											2							
	PROFIBUS DP + di/do											3							
OPTION C (standard)	no extensions																		
	INP3, INP4, OUT3, di/do																		
OPTION C (modular)	Motherboard without modules ²⁾																		
	Motherboard ordered modules inserted ²⁾																		
SETTING	Standard configuration																	0	
	Customer-specific configuration																	9	
	Operating instruction ³⁾																	0	
APPROVALS	Standard (CE certification)																		0
	cULus approval																		U
	DIN EN 14597 certified																		D

1) Not possible with Modular Option C!
 RM 200 not included in cULus approval !

2) Not possible with CANopen ! I/O modules must be ordered separately!
 Mind possible combinations and power limitations; → Text!

3) Detailed system manual can be ordered separately or downloaded (www.pma-online.de)

5.1 I/O-Modules

Can be installed on instruments with modular option C basic card.

Fig. 2 Table of I/O-module Versions

		9	4	0	7	9	9	8	0			1	
										↑	↑	↑	
										0			
SOCKETS	Singular order(separate delivery)									1			
										2			
Module group 1	{									3			
										4			
Module group 2	{												
ANALOG INPUTS	{									2	0		
										2	1		
										2	2		
ANALOG OUTPUTS	{									3	0		
										3	1		
DIGITAL SIGNALS	{									4	0		
										4	1		

3) Please note on your order: "mounted in KS98-1 in orderposition X"
4) Max. 1 current output module

5.2 Ex-factory setting

All delivered units permit operation, parameter setting and configuration via the front-panel keys. Instruments with default setting are delivered with a test engineering which permits testing of the basic instrument inputs and outputs (no I/O extension) without auxiliary means.

 This engineering is not suitable for controlling a system. For this purpose, a customer-specific engineering is required (see versions, section: Setting)

Instruments with "setting to specification" are delivered complete with an engineering. Code no. KS98-1xx-xx09x-xxx is specified on the type label.

Accessories delivered with the instrument:

Operating manual, 4 fixing clamps

5.3 Auxiliary equipment

Engineering Tool ET/KS 98plus

Simulation SIM/KS 98

PC-Adapter

Adapter cable for connecting a PC (Engineering Tool) to the front-panel interface socket of the KS 98-1.

Updates and Demos on the PMA- Homepage (www.pma-online.de)

6. Mounting

The instrument must be installed as described below. Required dimensions of the control cabinet cut-out and minimum clearances for installation of further units are shown in the drawing.

For mounting, insert the unit into the control cabinet or cabinet door cut-out. Push the instrument module fully home and mount it firmly by means of the locking screw. Four fixing clamps are delivered with the unit.

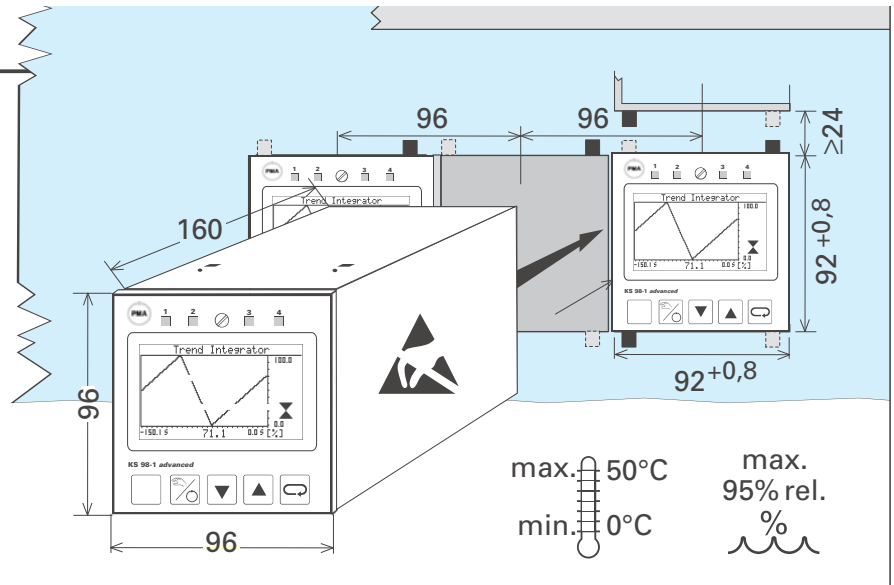
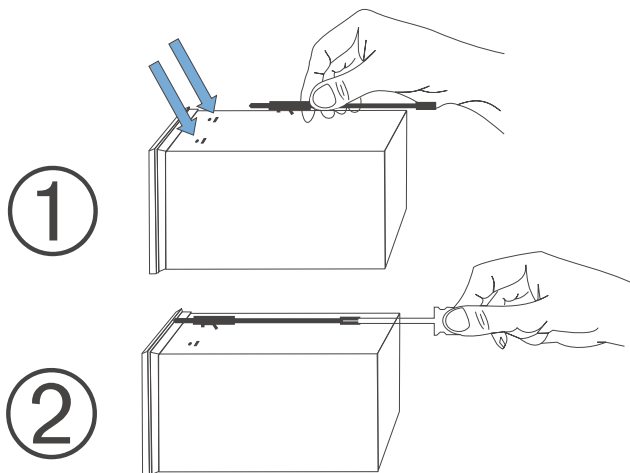

Fig. 3 Mounting

- ① These clamps have to be fitted in the instrument from the control cabinet inside: 2 at top and bottom.
- ② Now, the threaded pins of the fixing clamps can be screwed against the control cabinet from inside.

Fig.4 Inserting the fixing screws



A rubber seal is fitted on the rear of the instrument front panel (in mounting direction). This rubber seal must be in perfect condition, flush and cover the cut-out edges completely to ensure tightness!

cULus certification

cULus-certification

(Type 1, indoor use) File: E 208286

6.1 Function of wire-hook switches

For closing the wire-hook switches, release the locking screw, withdraw the instrument module from the housing and close the wire-hook switch. Re-insert the instrument and lock it.

Ex-factory setting

S	open
DP	open - terminating resistor not active
CAN	open - terminating resistor not active
TPS	A 14/12

 The unit contains electrostatically sensitive components. Comply with rules for protection against ESD during mounting.

Wire-hook switch S:

The switching status is signalled by function STATUS and can be used in the engineering for blocking e.g. operating pages and other settings.

Wire-hook switch for PROFIBUS DP (Option B):

The bus terminating resistor can be connected by 2 wire-hook switches (DP) in KS98-1. Both wire-hook switches must always be open or closed.

Wire-hook switch for CAN bus: (only Option CANbus):

Both ends of the CAN bus must be terminated (wire-hook switch closed).

Wire-hook switch for transmitter supply

Versions (KS98-11x-xxxxx) with transmitter supply are provided with a potential-free supply voltage for energization of a 2-wire transmitter, or of max. 4 control inputs.

The output connections can be made to terminals A4(+) - A1(-) by means of 3 wire-hook switches. If A14/A12 is used for di1/di2, A12 muß be linked with A1.

Connectors	①	②	③	Remarks	
14 (+)	12 (-)	T	open	closed	Only available with INP1 configured for current or thermocouple
4 (+)	1 (-)	D	closed	open	The voltage input of INP5 is then not available

Fig.5 Position of wire-hook switches

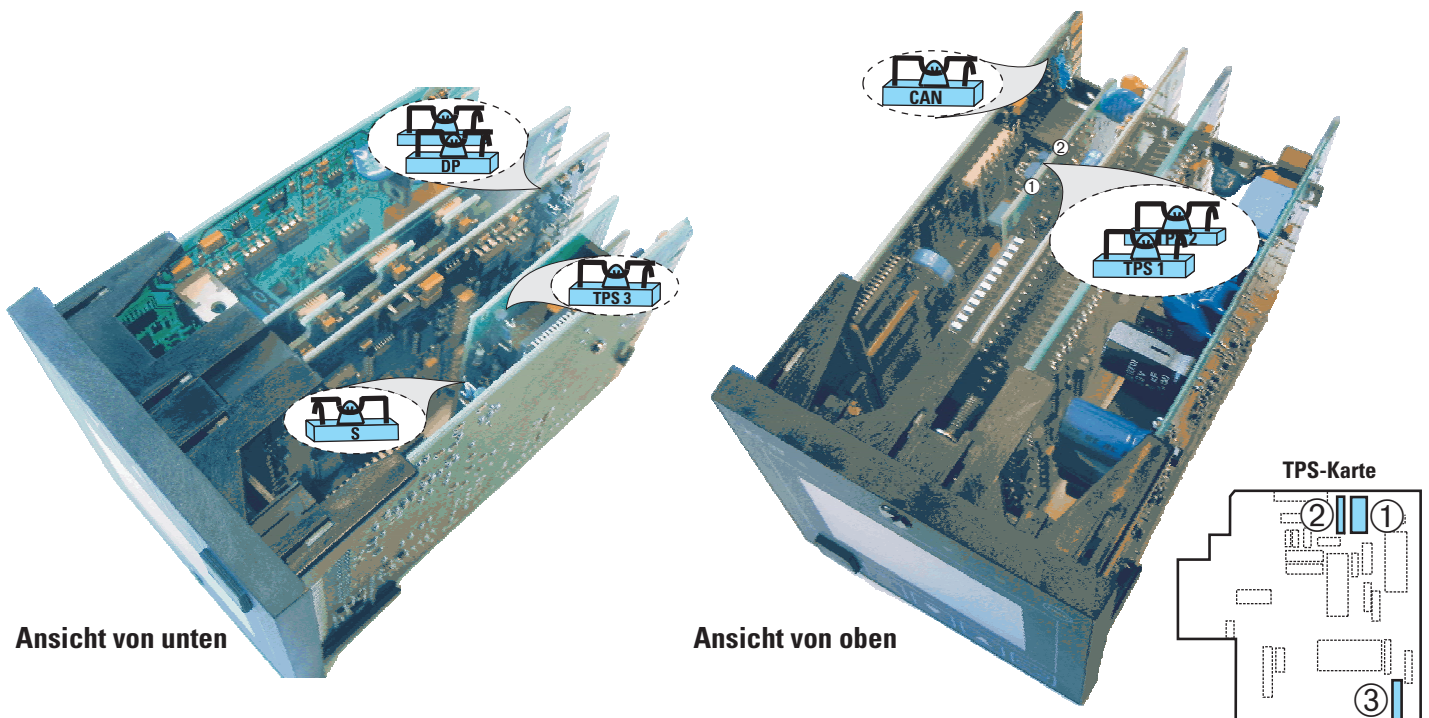

Connection 2-wire-transducer (e.g. INP1)

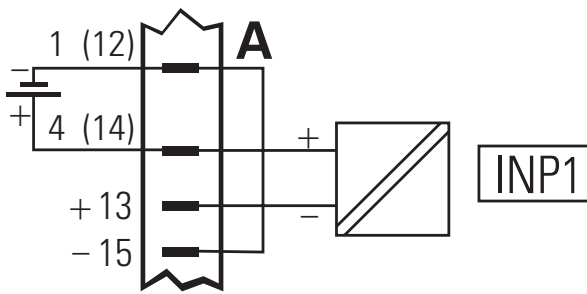

6.2 Retro-fitting and modific. of I/O-ext.

Only for instruments with modular option C!

-  The instrument contains electrostatically sensitive components. Original packing protects against electrostatic discharge (ESD),
 - transport only in original packing.
 - When mounting, rules for ESD protection must be taken into account.

Connection:

KS98 engineering must be taken into account, because it determines pin allocation and signification of connections.

Moreover, the rules for the performance limits must be followed (see manual → 9499-040-82711).

Mounting

After releasing the locking screw, withdraw the KS98 module from the housing.

a Insert the module into the required socket with the printed label pointing down-wards into the green connector and click it in position in the small, white contact **b** at the top.

Fig.6 Mounting of i/o modules socket *)

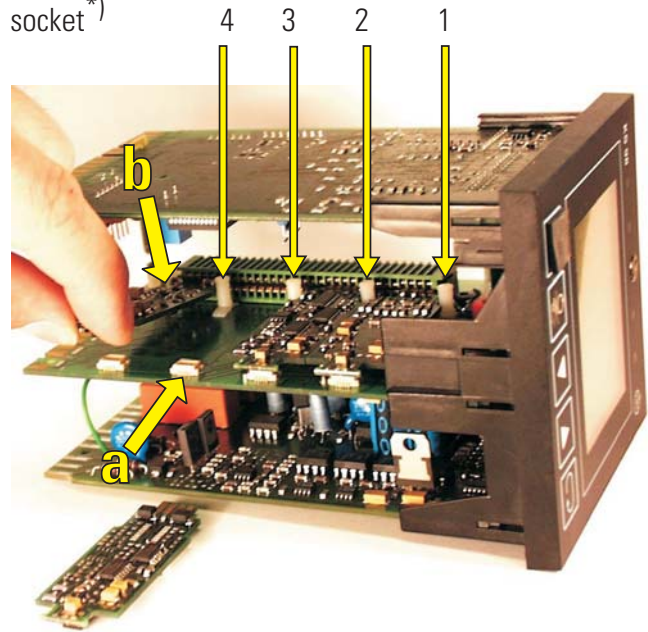

* watch connecting diagram

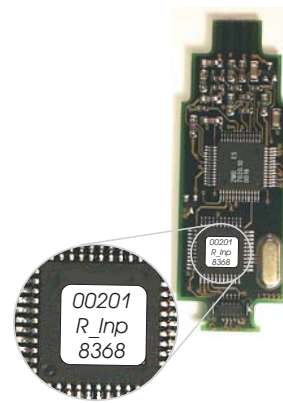

Fig. 7
The various modules are distinguished by printed label.
The last 5 digits of the ordernumber are given in the upper line.

6.3 I/O extension with CANopen

The unit offers a CANopen-compliant interface port for connection of the RM 200 system, KS 800 or additional KS 98-1 units with max. five CAN nodes.

See installation notes in the CANopen system manual (9499-040-62418).

7. Electrical connections

7.1 Safety hints



Following the safety notes starting on page 6 is indispensable!

The installation must be provided with a switch or power circuit breaker which must be marked accordingly. The switch must be located near the instrument and readily accessible for the operator.



When the instrument module is withdrawn from the housing, protection against dropping of conducting parts into the open housing must be fitted.



The protective earth terminal (P3) must be connected to the cabinet ground. This applies also to 24V supply.

7.2 Electromagnetic compatibility

European guideline 89/336/EEC. The following European standards are met: EN 61326-1.

The unit can be installed in industrial areas (risk of radio interference in residential areas). A considerable increase of the electromagnetic compatibility is possible by the following measures:

- Installation of the unit in an earthed metal control cabinet.
- Keeping power supply cables separate from signal and measurement cables.
- Using twisted and screened measurement and signal cables (connect the screening to measurement earth).
- Providing connected motor actuators with protective circuitry to manufacturer specifications. This measure prevents high voltage peaks which may cause trouble of the instrument.

7.3 Measurement earth connection

Measurement earth connection is required for protection against interference. External interference voltages (incl. radio frequencies) may affect the perfect function of the device.

To ensure protection against interference, the measurement earth must be connected to cabinet ground.



Terminals A11(measurement earth) and P3 (protective earth) must be connected to cabinet ground via a short cable (approx. 20 cm)! The protective earth conductor of the power supply cable must also be connected to this earth potential (cabinet ground).
→ See also diagram on page 22

7.4 RC protective circuitry

Load current free connections between the ground potentials must be realized so that they are suitable both for the low-frequency range (safety of persons, etc.) and the high-frequency range (good EMC values). The connections must be made with low impedance.

All metal grounds of the components installed in the cabinet ① or in the cabinet door ② must be screwed directly to the sheet-metal grounding plate to ensure good and durable contact.

In particular, this applies to earthing rails ④, protective earth rail ⑤, mountingplates for switching units ⑦ and door earthing strips ⑥. Controllers KS40/50/90 ⑧ and KS98-1 ⑨ are shown as an example for earthing.

The max. length of connections is 20 cm (see relevant operating instructions).

Generally, the yellow/green protective earth is too long to provide a high-quality ground connection for high-frequency interferences.

Fig. 9 connecting diagram

Please mind footnotes!
 KS98-1 with screw terminals
 only!

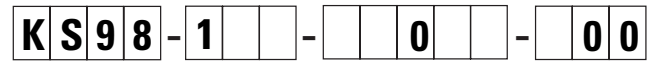

BASIC UNIT	KS 98 Standard	0										
	KS 98 with transmitter power supply	1										
	KS 98 with CANopen I/O ¹⁾	2										
POWER SUPPLY AND CONTROL OUTPUTS	90...250V, AC 4 relays	0										
	24V UC, 4 relays	1										
	90...250V AC, 2 relays+ 2 mA/logic	4										
	24V UC, 2 relays+ 2 mA/logic	5										
OPTION B INTERFACE	no interface		0									
	TTL interface + di/do		1									
	RS422 + di/do + clock		2									
	PROFIBUS DP + di/do		3									
OPTION C (standard)	no extensions			0								
	INP3, INP4, OUT3, di/do			1								
OPTION C (modular)	Motherboard without modules ²⁾			3								
	Motherboard ordered modules inserted ²⁾			4								
SETTING	Standard configuration							0				
	Customer-specific configuration							9				
	Operating instruction ³⁾								0			
APPROVALS	Standard (CE certification)											0
	cULus approval											U
	DIN EN 14597 certified											D

1) Not possible with Modular Option C!
 RM 200 not included in cULus approval !

2) Not possible with CANopen ! I/O modules must be ordered separately!
 Mind possible combinations and power limitations; → Text!

3) Detailed system manual can be ordered separately or downloaded (www.pma-online.de)



For instruments with modular option C → see connecting diagram on page 25

- ❶ The protective earth must be connected also with 24 V DC / AC supply (see safety notes on page 21).
The polarity is uncritical.
- ❷ Only on versions with transmitter power supply (factory setting: connection to terminals A12-A14). Connection of the transmitter power supply is determined by the wire-hook switch → page 19.

7.7 Analog inputs

Thermocouples

- ❸ see general connecting diagram on page 23.
No lead resistance adjustment.

Internal temperature compensation:

compensating lead up to the instrument terminals. With AINP1, **STK = int.CJC** must be configured.

External temperature compensation:

Use separate cold junction reference with fixed reference temperature.

Compensating lead is used up to the cold junction reference. Copper lead between reference and instrument. With AINP1, **STK = ext.CJC** and **TKref =** reference temperature must be configured.

Resistance thermometer

- ❹ Pt 100 in 3-wire connection. Lead resistance adjustment is not necessary, if RL1 is equal RL2.

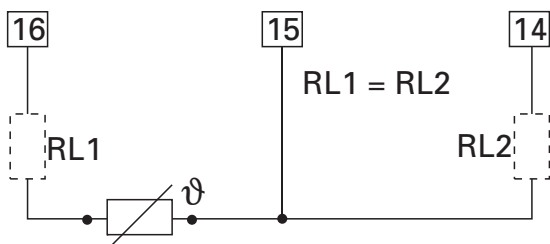

Resistance thermometer

- ❺ Pt 100 in 2-wire connection. Lead resistance adjustment is necessary: Ra must be equal to RL1 + RL2.

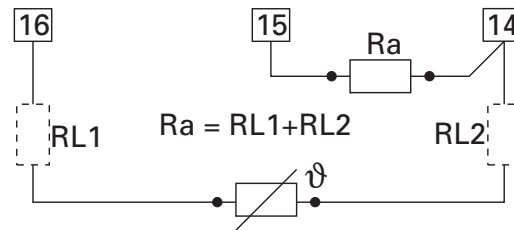

Two resistance thermometer

- ❻ Pt100 for difference. Lead resistance compensation: proceed as described in chapter calibration page 32 - 10.4.

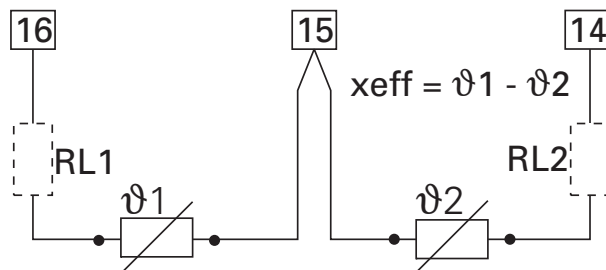

- ❼ Resistance transducer
Measurement calibration → proceed as described in chapter calibration page 32 - 10.4.

Standard current signals 0/4...20 mA

- ❽ Input resistance: 50 Ω, configure scaling and digits behind the decimal point.

Standard voltage signals 0/2...10V

- ❾ Input resistance: ≥ 100 kΩ
(Voltage input module U_INP: >1 GΩ),
configure scaling and digits behind the decimal point.

👉 INP5 is a difference input, the reference potential of which is connected to terminal A9. With voltage input, A6 must always be connected to A9.

⚠️ **The inputs INP1 / INP6 are interconnected (common reference potential). This must be taken into account if both inputs must be used for standard current signal. If necessary, galvanic isolation should be used.**

7.8 Digital in- and outputs

The digital inputs and outputs must be energized from one or several external 24 V DC sources. Power consumption is 5 mA per input. The max. load is 70 m A per output.

Examples:

Digital inputs (connector A)

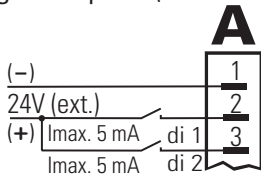

Digital inputs and outputs at one voltage source (e.g. connector B) 70mA!

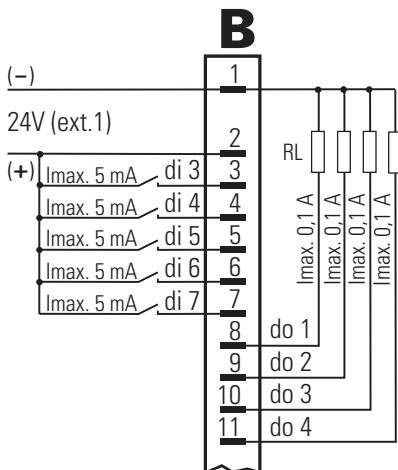

Digital inputs and outputs at two voltage sources (e.g. connector B)

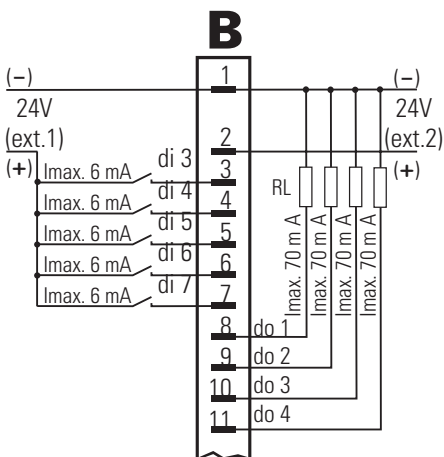

7.9 Connecting diagram i/o-modules

(Modular Option C)

CAN and modular option C are mutually precluding.

The inputs and outputs of multi-function unit KS98-1 can be adapted to the individual application by means of "modulare option C. The supporting card is firmly installed in the unit.

The card contains four sockets for various I/O modules which can be combined, whereby the positions of the various connection types are dependent on engineering.

The KS98-1 programming personnel must provide a connecting diagram corresponding to the block diagram (→ page 26) for installation of the device.

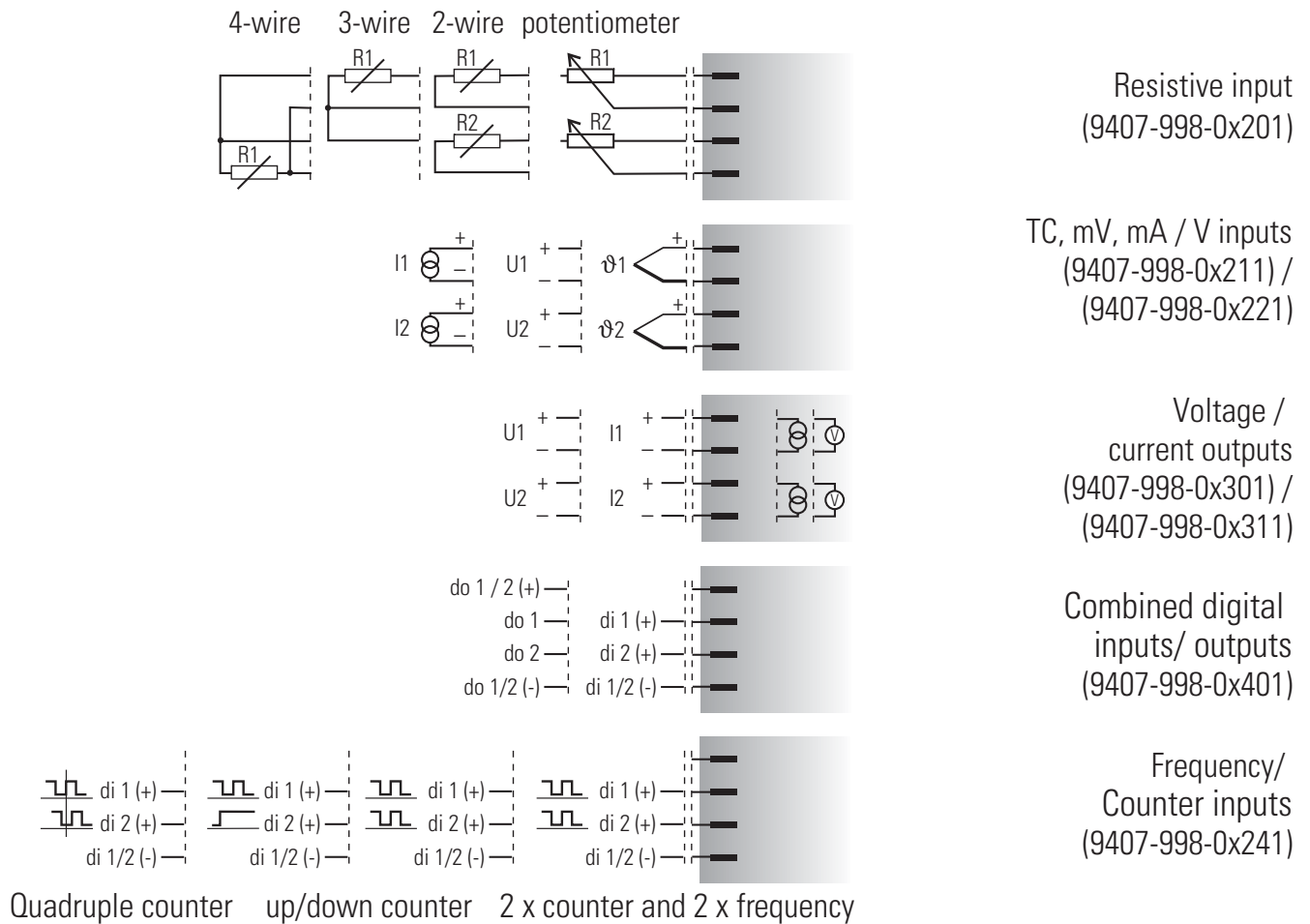

8. Commissioning

Before switching on the instrument, ensure that the following points were taken into account:

- The supply voltage must correspond to the specification on the type label!
- All covers required for contact protection must be fitted.
- Before operation start, check that other equipment in the same signal loop is not affected. If necessary, appropriate measures must be taken.
- The unit is freely configurable. For this reason, the input and output behaviour is determined by the loaded engineering. Before commissioning, make sure that the right instructions for system and instrument commissioning are available.

Unless an application-specific engineering was loaded, the unit is equipped with the IO test engineering described on page 44. Before instrument switch-on, the plant-specific input and output signal types must be adjusted on the instrument, in order to avoid damage to the plant and to the device

On instruments without default setting, partial I/O signal testing is possible.



The effect on connected equipment must be taken into account.

After supply voltage switch-on, *start-up logo* and **Main menu wait!** are displayed, followed by display of the main menu during several seconds .

Unless a selection is made during this time, the first operating page (e.g. a controller) is displayed automatically, without marking a line or a field.

9. Operation

The operation of the device is menu-guided. The menu is divided into several levels which can all be influenced via the engineering, i.e. the final scope of the menu is dependent on the engineering.

This manual describes the operating functions which are independent of the engineering.

9.1 Front view

LEDs (①②③④):

for indication of conditions determined by the engineering, e.g. alarms or switching states.

⏻⏮⏭⏪ keys (⑦⑪⑩⑨):

Operation is by four keys for selection of pages and input on pages.

⏮⏭ The two functions of keys up/down are:

- Navigation in menus and on pages
- Changing input values (e.g. set-point)

⏻ The two significations of the selector key are dependent on the selected field:

Pressing the selector key (confirmation / Enter):

- starts page changing,
- starts value alteration via the up/down keys and confirms the adjustment subsequently (→ page 29).

⏻ The functions of the auto/manual key are dependent on operating page, i.e. this key is sometimes called function key.

- Controller: auto/manual switchover
- Programmer: programmer control
- Adjustment of digital values.



⑤ Locking screw:

for locking the instrument module in the housing

⑥ PC interface:

PC interface for engineering tool ET/KS98 and BlueControl. The tools permit structuring/soft-wiring/configuration/parameter setting/operation.

⑧ Display/operating page:

- LCD point matrix (160 x 80 dots),
- changeable green/red back lighting, direct/inverse display mode.

Display is dependent on configured functions.

9.2 Menu structure

The main menu is the uppermost menu level. Its structure is fixed and independent from the engineering.

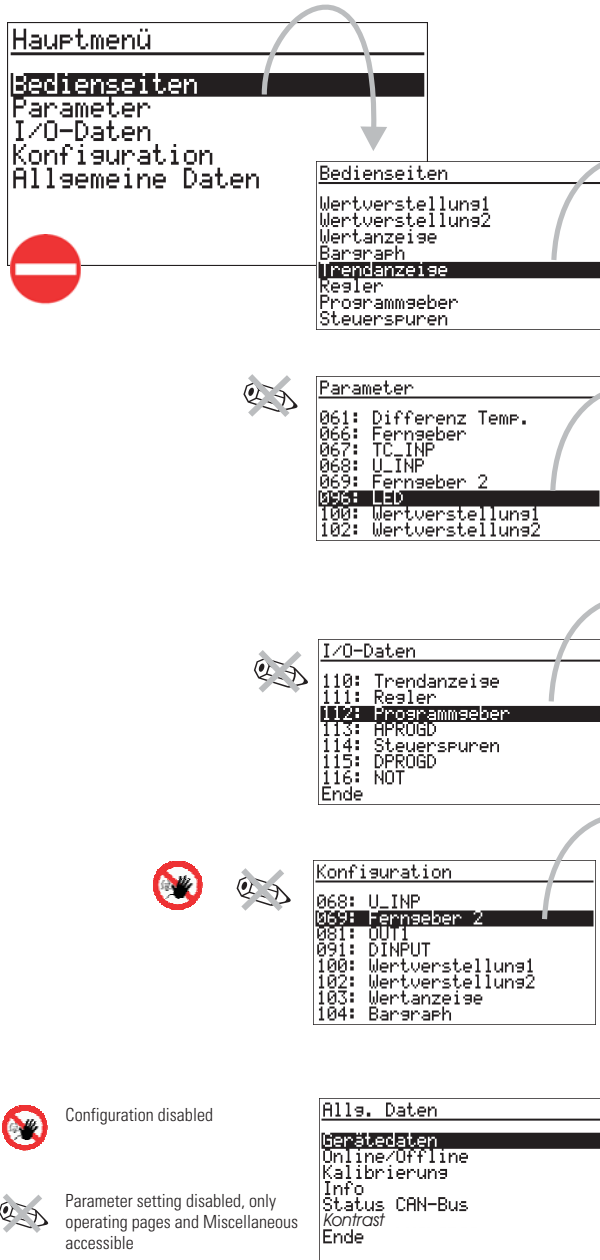

Examples:

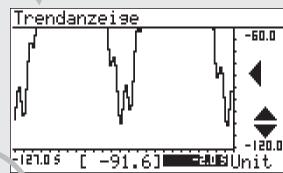

Dependent on engineering, the operating pages of the engineering are listed and can be selected.

096: LED Parameter	
Inv 1 =	direkt
Inv 2 =	direkt
Inv 3 =	direkt
Inv 4 =	direkt
Ende	

List of all functions which contain parameters.

112: Programmer	
i: PSet =	0.000
i: DBlock =	113.00
i: ProgNo =	0.000
i: XVal =	0.000
i: SlavNo =	114.00
i: hide =	aus
i: lock =	aus
i: run =	aus

List of all functions for display of input/output values

069: res.transducer2	
Upr_a =	Pt.100 850
Fail_a =	Upscale
Xbkorr =	aus
Unit_a =	°C
Upr_b =	Pt.100 850
Fail_b =	Upscale
Xbkorr =	aus
Unit_b =	°C

List of all functions which contain configuration parameters

Configuration disabled

Parameter setting disabled, only operating pages and Miscellaneous accessible

If the main menu is disabled, only operating pages and user menu are accessible.

Anwendermenü
Info
Status CAN-Bus
Status PROFIBUS
Ende

- Date, time: display and setting (only with option B, RS 422)
- Device data: interface, mains frequency, language display and setting (only with option B, TTL/RS422)
- Online/Offline: online i offline, configuration cancelling.
- Calibration: display and setting of signals to be calibrated
- Info: hardware, software order no., software release no. display (only with option B, PROFIBUS)
- Status PROFIBUS: bus access status, data communication, available Profibus sharing units (only with option B, PROFIBUS)
- Status CANbus: bus access status, data communication, available CANbus sharing units (only with CAN version)
- Status ModC: fitted modules and power limit
- Contrast: LCD display contrast setting

9.3 Navigation, page selection

Operation of the device is by keys and . After pressing key during 3 seconds, the main menu is always displayed.

When the main menu is disabled the user menu is displayed.

Example: Parameters

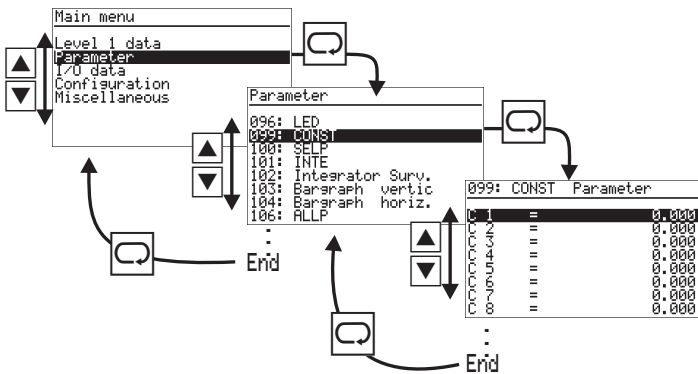

Procedure

- 1 Press to select the input field or the line (the selected item is shown inversely).
- 2 Confirm the entry with (for selecting).
- 3 a) If the selected item is a page, the page is opened and navigation can be continued with the keys.
- 3 b) If an input field was selected, the field starts blinking after pressing key and the required change can be entered with the keys. Confirm with key . The input field stops blinking and the alteration is saved.
- 4 For exit from a page, scroll to menu item "End" at the bottom of the list. When selecting () , the next higher menu level is displayed.

Scrolling is possible. When exceeding the uppermost menu item, menu item "End" is displayed.

Unless display of a page is inverse despite actuation of keys , the items were disabled (e.g. via engineering).

An inverse menu item which cannot be altered is also disabled.

Operating pages:

These pages offer an additional navigation function:

- Continuation or previous pages (marked by an arrow at the bottom () or top () of the page) can be activated by selecting and pressing key .
- Items marked with open another operating page when selecting () and confirming with key .

Menu item "End" is not provided on operating pages. Scroll until nothing is selected any more (no input field/line is shown inversely) and press key to go to the next higher menu level.

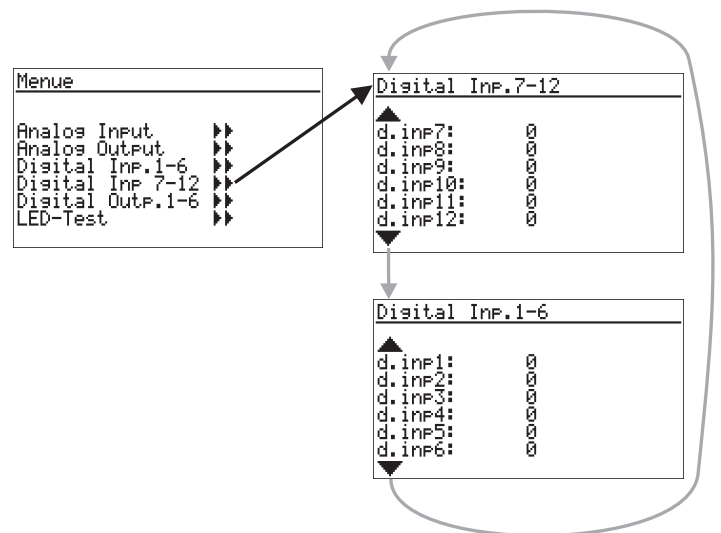

9.4 Adjusting values

The menu operating pages include various types of fields for adjustment of values:

- analog values, digital values
- selection lists
- times
- on/off switches
- push-buttons
- selector switches (radio button)

Adjustment procedure

Select the value to be altered with keys ▲▼.

a) Press key □ to start value changing (field blinks). Change the value with keys ▲▼. Press □ to store the change (field stops blinking).

Fig. Example: Value adjustment bargraf

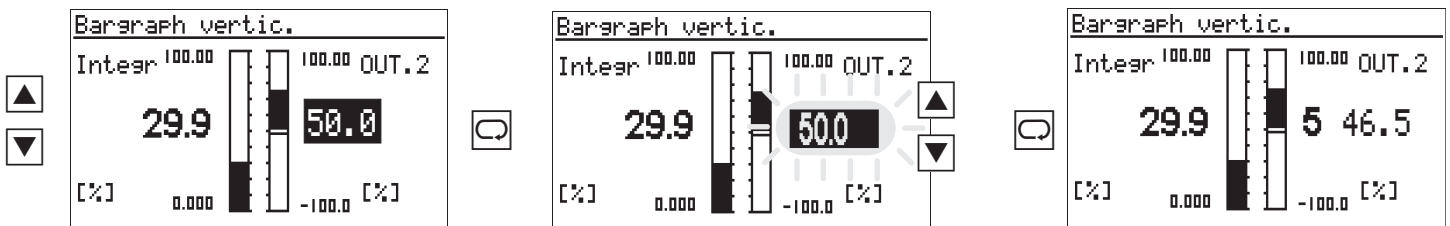

The longer keys up/down are pressed, the higher is the acceleration. When releasing, the adjustment speed decreases accordingly.

b) Key □. This mode of adjustment is provided for switches, push-buttons and selector switches.

Fig. b) Key □. This mode of adjustment is for switches, push-buttons and selector switches.

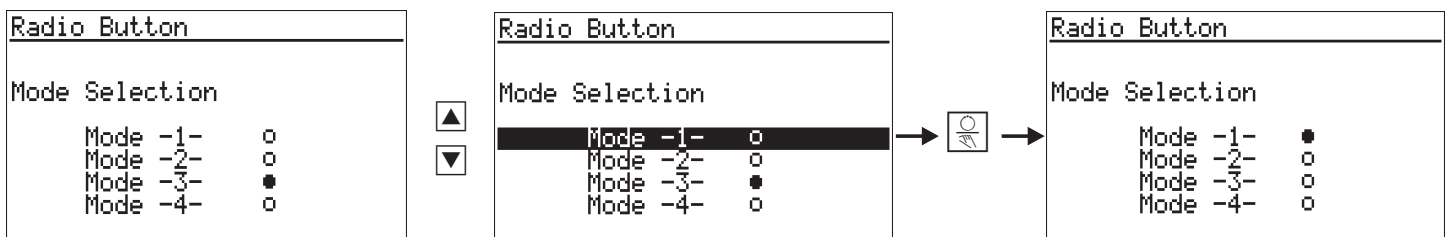

10. Instrument settings

10.1 CAN-Status

```
Status CAN-Bus
1: OK-NA-NU-ich bins
2: NC-NA-NU-
3: OK-Op-OK-MOD I/O
4: NC-NA-NU-
5: OK-Op-OK-MOD I/O
6: NC-NA-NU-
```

The CAN bus status with the connected units is displayed.

Value	Signification
1..42	Node number
NC	<u>NoCheck:</u> Node existence not checked so far / node not provided
Ck	<u>Check:</u> Node existence just being checked.
NR	<u>NoResponse:</u> No reply from this node, but node is required
OK	<u>Ready:</u> Node has replied and is identified
ES	<u>EMStart:</u> Node has provided an emergency message
NA	<u>NotAvailable:</u> Node status is unknown
PO	<u>PreOperation:</u> Node is in the PreOperational status.
Er	<u>Error:</u> Node is in error status
Op	<u>Operational:</u> Node is in Operational status.
NU	<u>NotUsed:</u> Node is not required by an own lib function.
Wa	<u>Waiting:</u> Lib function waits for identification of this node.
Pa	<u>Parametrierung:</u> Lib function just setting the node parameters
OK	<u>Ready:</u> Lib function has finished the parameter setting.
String	determined node name

10.2 Profibus-Status

The Profibus status page provides information on the Profibus status of connection. The following error statuses are displayed:

```
Status PROFIBUS
Bus access      = O.K.
Parameter      = O.K.
Configurat.    = error
Data exchnge   = error
End
```

- Bus access not successful
- Faulty parameter setting
- Faulty configuration
- No data communication

10.3 ModC-Status

The status page of the modular C card provides information on correct installation. Possible faulty installations are displayed:

```
Status Mod-C
67: TC_INP = O.K.
68: R_INP  = O.K.
---  ---
70: I_OUT  = O.K.
    Power  = O.K.
Ende
```

- Difference of configured and fitted module type
- Power limits exceeded

10.4 Calibration

Press to select the input and to open the calibration page.

Transducer input:

Adjusting the transducer start and end:

```

Fernseber
-----
x0      =          0.000
x100   =         100.00
X       =          0.000
fail    =          aus
Y       =          0.0
                               Set  0%
  
```

- ① Select **Quit** Set transducer to start
- ② Press → **Quit** blinks
- ③ Press → **Set 0%** blinks
- ④ Wait until the input has settled (min. 6 s)
- ⑤ Press → **0% done** is displayed
- ⑥ Set transducer to end
- ⑦ Press → **0% done** blinks
- ⑧ Press 3x → **Set 100%** blinks
- ⑨ Wait until the input has settled
- ⑩ Press → **100% done** is displayed.

Calibration is finished. For exit from calibration press until nothing is marked and then press .

Two resistance thermometers:

Calibration of lead resistance effect

```

Differenz Temp.
-----
x0      =          0.000
x100   =          0.000
X       =          0.009
fail    =          aus
Y       =          0.0
Man.    =          Cal done
  
```

- ① Select **Quit** .
Short-circuit both thermometers in the connecting head
- ② Press → **Quit** blinks
- ③ Press → **Set Dif** blinks
- ④ Wait until the input has settled (min. 6 s)
- ⑤ Press → **Cal done** is displayed

Lead resistance adjustment is finished. Remove both short circuits.

For exit from calibration press until nothing is marked and then press .

10.5 Online/Offline

For configuration changing, switch the unit to 'Offline' and back to 'Online'.



When switching the unit to status off-line, the outputs will remain in the status at switch-over time !!!



By switching over to on-line, all data are saved.



When terminating the off-line mode by cancellation (Escape config.) the data saved last are loaded back into the working memory.

11. Operating pages

The engineering determines the scope of available operating pages. All available pages are listed in the operating page menu.

The various types of pages are explained below.

11.1 List display

The operating page list is intended for display/input of process values and parameters.

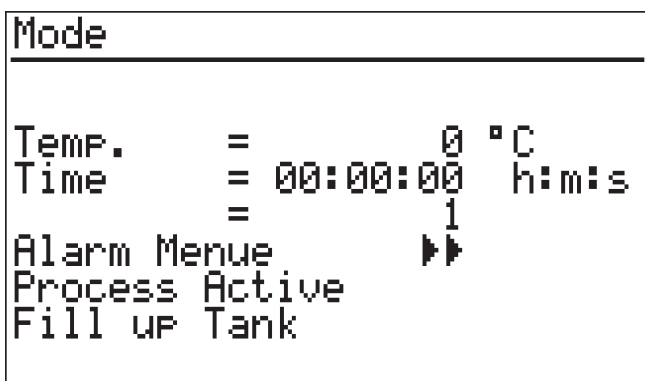

Apart from digital, analog and time values, values of type radio button, switch and push-button can be defined in the value listing (→ page 30).

The value signification is determined by the engineering. The displayed values can be input fields.

11.2 Bargraph display

The bargraph page is used for display of two analog variables as a bargraph.

Two further variables can be displayed and changed numerically and need not correspond with the bargraph values.

Four further analog inputs can be used to position two markers at the bargraph side, e.g. for indication of the alarm limit or reference values. When exceeding the limits, an arrow ▼ is displayed at the top and bottom end of the bargraph ▼ (see page 45).

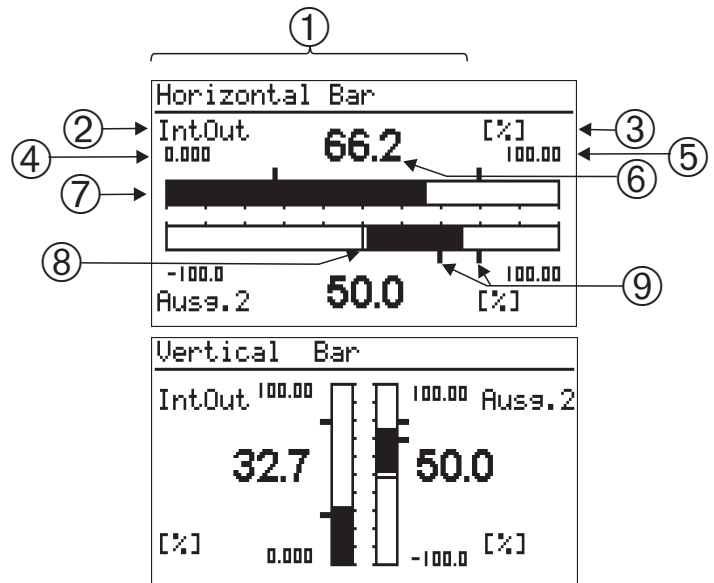

- ① Title
- ② Name for value
- ③ Unit for value
- ④ ⑤ Scale end values
- ⑥ Display/input field for value
- ⑦ Bargraph
- ⑧ Bargraph origin
- ⑨ Limit value markers for bargraph

11.3 Alarm display

Alarm display is in the order of occurrence on a list. One alarm per line is displayed:

- Alarm active alarm text blinks
- Alarm active and ackn. Alarm text
- Alarm not active any more and not acknowledged Alarm text ▶▶▶
- Alarm not active any more -----

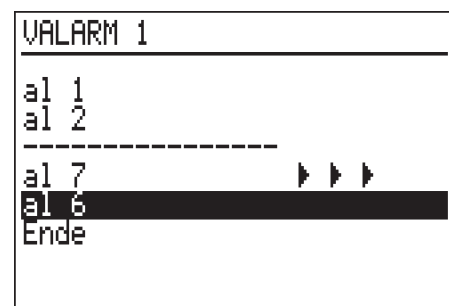

Acknowledging an alarm

Select an active alarm for acknowledging with and acknowledge it with .

New alarms are displayed only when rebuilding up the page, which is done by pressing key H.

11.4 Graphic trend curve

The time curve of a process is displayed graphically on the trend page.

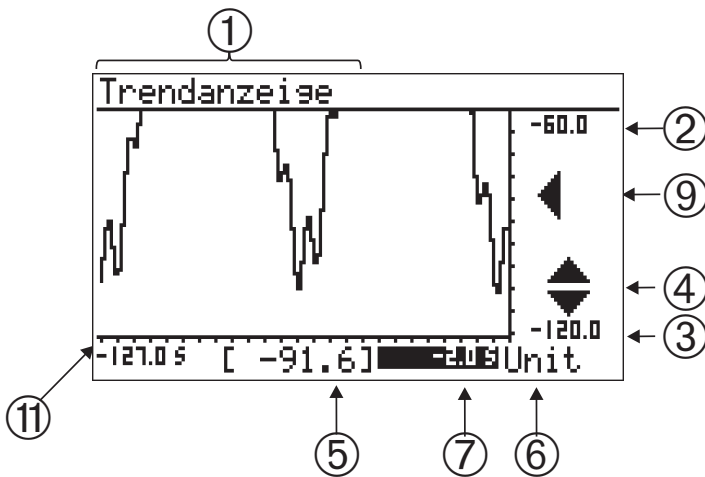

- ① Title
- ② ③ Scale end values
- ④ Zoom switchover
- ⑤ Value at time ⑦ / actual input value
- ⑥ Unit of value
- ⑦ Origin of time axis related to the actual value (=0) shift of time axis (scrolling into the past)
- ⑧ Origin of time axis
- ⑨ Axis shift signalling
- ⑩ Axis shift signalling
- ⑪ End of time axis / earliest value in the displayed trend

Zoom value scale

The value axis can be zoomed by factor 1:4 (cut-out magnification).

- Select the "zoom" field £, press M, the zoom symbol changes. Now, scaling can be changed by means of keys ID. The scaling is shifted in steps of 12,5% via field ø.
-
-

Time axis switchover:

Earlier values than those visible in the actual window are also displayed by the trend function (Shift). Values left of the time axis are earlier values. These values can be displayed by changing the origin of the time axis.

Select field ⑦ with and shift the scale origin by changing the value.

Symbol (⑨) indicates the shift.

When resetting the time scale to 0, the shift is switched off.

11.5 Programmer

A programmer controls the process sequence of a plant. Programmers are configurable freely in structure and scope by means of the engineering. A programmer is composed of any number of set-points (analog values) and control values (digital control bits). Any number of programs (recipes) can be stored for a programmer.

- The program is divided into a defined number of segments (program segments).
- The maximum number of segments is determined in the engineering.
- The maximum scope is defined in the engineering.

The actual status of a running program is displayed on the programmer operating page. Dependent on programming, status (run/stop, auto/manual), segment number, net time and the actual set-point (during manual operation) can be changed.

Programmer operation is divided into:

- Program control and monitoring
- Program (recipe) selection
- Adjustment of setpoints/control bits during manual operation
- Parameter setting for program

Dependent on engineering, parts of this operation can be changed or disabled.

Display of the operating page is always related to one programmer output, whereby analog set-points and digital control bits are distinguished. Change to the next programmer output is via field ⑥ ►► in the title.

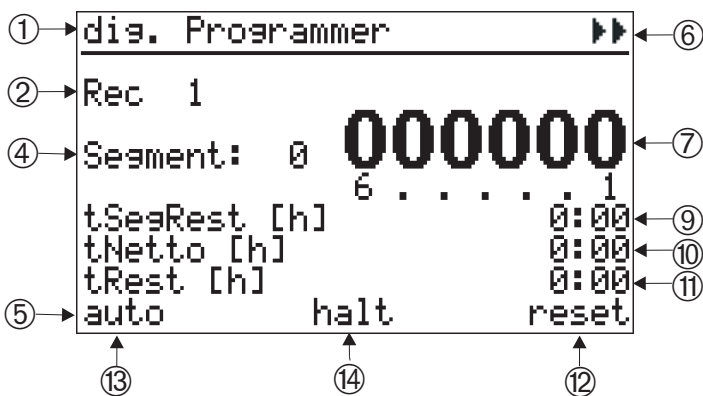
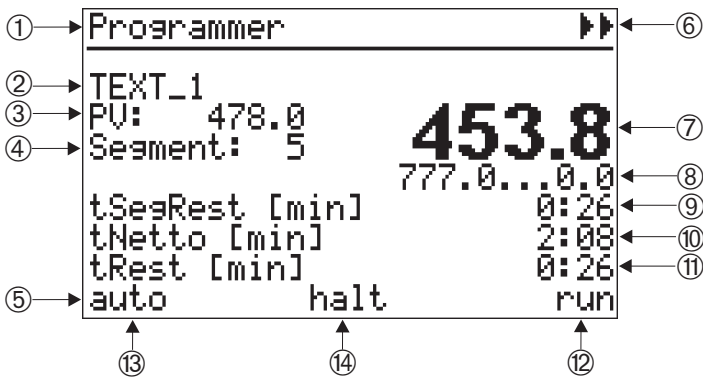

- ① Name of operating page
- ② Program name/no. (recipe)
- ③ [Process value]
- ④ Actual segment no.
- ⑤ Status line
- ⑥ Programmer output switchover
- ⑦ Set-point/control value
- ⑧ Setpoint from...to in the current segment
- ⑨ Remaining segment time
- ⑩ Elapsed program time
- ⑪ Remaining program time
- ⑫ Program status
(stop,run,reset,search,program,quit,error)
- ⑬ auto/manual
- ⑭ halt, end

Selecting a program

Selection of a program is by alteration of recipe field i. Dependent on engineering, selection is from a text list or by entry of a number.

Program selection is possible only in status "reset".

Controlling a program

Press key to control the program sequence: The time curve can be controlled also by changing the elapsed time ⑩ or segment number ④ (pre-set).

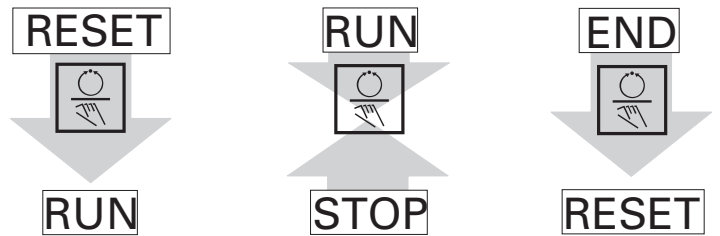

Dependent on engineering, parts of this operation may be changed or disabled.

Program parameter setting

Select the program for editing via field "Rec" ②. Call up the relevant set-points/control values, segment times and types with menu item "program" in the status line (field ⑫).

A page on which the selected program is displayed as "RecEdt" is opened.

The parameters are listed in the order of segments.

The data blocks are displayed dependent on engineering.

The type of individual segments can be changed dependent on data block type.

Selection of all programs including the inactive ones is possible on line **RecEdt** in any programmer status.

```

Programmer
-----
Rec_1
PV: 478.0
Segment: 4
          444.0...777.0
tSegRest [min] 0:43
tNetto [min] 1:08
tRest [min] 1:26
auto halt
Program
    
```

```

Programmer
-----
RecEdit = Rec_1
WP 0 = 0.0
TP 1 = 0:22
WP 1 = 222.0
TP 2 = 0:11
WP 2 = 333.0
TP 3 = 0:33
WP 3 = 444.0
WP2 = Zeit
TP3 = Zeit
WP3 = Wert
TP4 = Zeit
.
.
.
WFn = Wert
TFn+1 = --:--
Ende
    
```



When using recipe names, these names are displayed on the editing page. Switching over to the parameters of a different recipe can be done by altering the recipe name. This is possible at any time and does not cause switchover of the active recipe.

```

Programmer
-----
RecEdit = APR0302 - Rec.
WP 0 = 0.0
Typ 1 = Zeit
TP 1 = 0:10
WP 1 = 100.0
Typ 2 = Gradient
Rt 2 = 1.500
WP 2 = 200.0
    
```

Parameter Step 1 {
Parameter Step 2 {

A segment list is completed with end identification --:-- in parameter T_{p_n} of the last segment.

When setting the last segment time T_n to a valid value (higher or equal to 0), the next parameter is displayed automatically

$T_{n+1} = --:--$ etc.

This procedure permits shortening of a current program by adjusting a value < 0 in the required position for $T_n = --:--$ with key \blacktriangledown . The following segments will be suppressed in the program. The relevant segment parameters remain unchanged and can be re-activated by input of a valid value for T_n .

Segment type

Dependent on segment type, the following parameters can be altered:

- Wp i Target setpoint
- Di Control value in segment i
- Tp i Segment duration
- Rt i Segment gradient
- Typ i Segment type

Ramp segment (time)

With a ramp segment (time), the set-point runs linearly from the start value (end of previous segment) towards the target set-point (Wp) of the relevant segment during time T_p (segment duration).

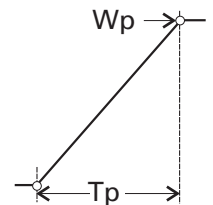

Ramp segment (gradient)

With a ramp segment (gradient), the set-point runs linearly from the start value (end value of previous segment) towards the target value (Wp) of the relevant segment. The gradient is determined by parameter R_t .

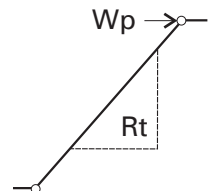

Hold segment

With a hold segment, the end set-point of the previous segment is output constantly during a defined time which is determined by parameter T_p .

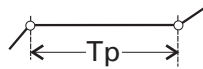

Step segment

With a step segment, the program set-point goes directly to the value specified in parameter W_p .

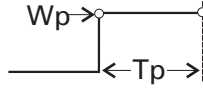

The set-point reached due to the step change is kept constant during the time determined in parameter T_p .

Manual mode

The programmer output can be overwritten for each page. For this, the relevant page must be switched of to "manual". In this mode, the set-point or control value can be overwritten (7). The control value is changed separately for each control bit. Press M to continue.

Field (13) permits returning to the automatic mode (→ page 35).

The program run is not interrupted by the manual mode.

Waiting and operator call

All segment types can be combined with "Wait at the end and operator call".

If a segment with combination "wait" was configured, the programmer goes to stop mode at the segment end. Now, the programmer can be restarted by pressing the -key.

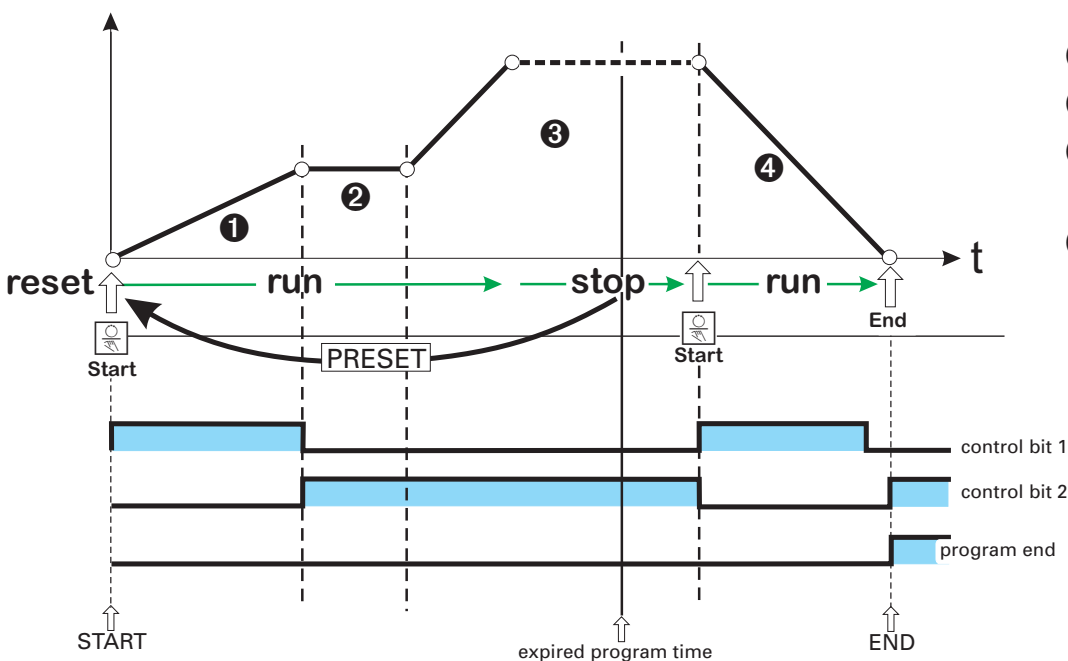

- 1 Segment type = Time
- 2 Segment type = Hold
- 3 Segment type = Time and wait
- 4 Segment type = Gradient

11.6 Controller

The controller page permits intervention into process control loops. Input fields (set-point, set-point source, correcting variable during manual mode, parameter set switchover) are selected via the $\blacktriangle/\blacktriangledown$ key, pure display fields are skipped.



 Dependent on engineering, the input fields can be disabled.

Fig.: Controller operation

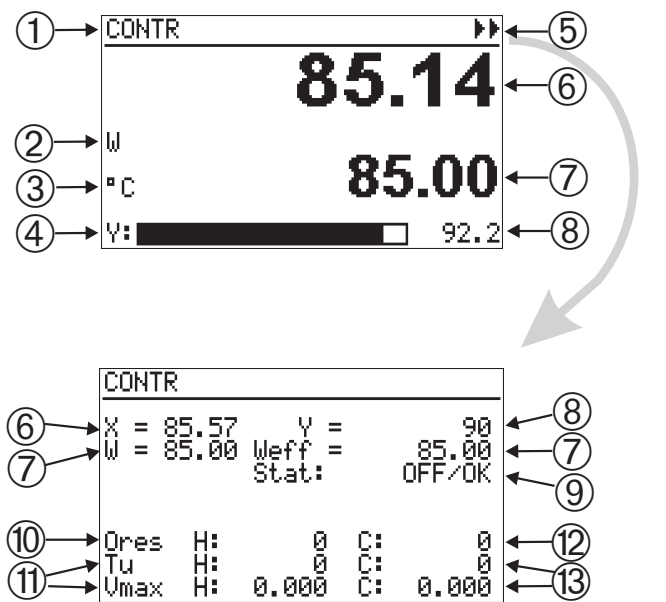

- ① Page title
- ② Set-point source (Wint, Wext, W2)
- ③ Physical unit
- ④ Bargraph of correcting variable Y or XW or Xeff
- ⑤ Entrance into the self-tuning page
- ⑥ Effective process value
- ⑦ Controller set-point
- ⑧ Value of correcting variable Y or XW or Xeff
- ⑨ Self-tuning/command input status
- ⑩ Self-tuning result heating
- ⑪ Process characteristics heating
- ⑫ Self-tuning result cooling
- ⑬ Process characteristics cooling

Apart from entries and switchover operations, further actions can be started:

Switching over to manual operation is done via key  and field - ⑤ provides access to the controller self-tuning page.

Input fields on the operating page

Manual correcting variable

Alteration of manual correcting variable ⑧ by means of keys $\blacktriangle/\blacktriangledown$ is at three speeds.

Fig.:Correcting variable adjustment via the front panel

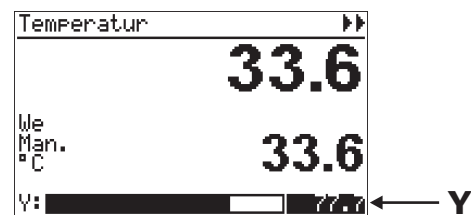

Press the key to start the adjustment at a speed of 1% / sec. After 3 sec., switchover to 2.5% / sec occurs and switchover to 10%/sec. is after another 3 sec.

Set-point

The internal set-point can be altered at any time, also when another set-point is active.

Fig.:Set-point adjustment via the front panel

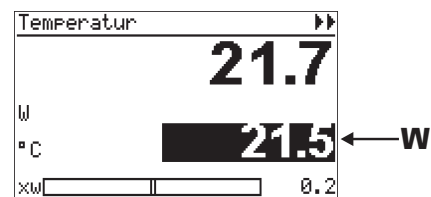

Set-point source

Set-point source switchover is possible via a selection field on the controller page.

Front-panel set-point switchover

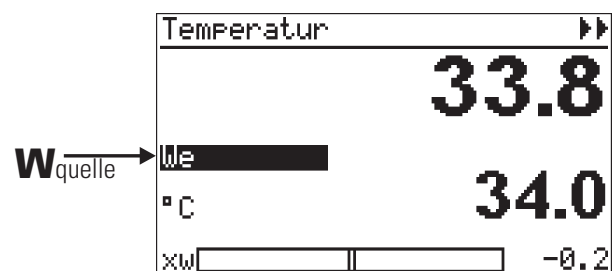

Dependent on controller configuration, selection of Wint, Wext and W2 is possible. Unless switchover is required, the field can be left with Quit.

Self tuning

Determination of the optimum process parameters is possible by self-tuning. Self-tuning is available for processes with recovery time and without delay time.

Dependent on controller type, parameters **XP1**, **XP2**, **Tn**, **Tv**, **TP1**, **TP2** are determined.

Preparation

- Adjust the desired controller behaviour.
- $e = 0.0$.
- P- controller: $Tn = 0.0$ $Tv = 0.0$
- PD- controller: $Tn = 0.0$ $Tv > 0.0$
- PI- controller: $Tn > 0.0$ $Tv = 0.0$
- PID- controller: $Tn > 0.0$ $Tv > 0.0$
- If a controller has several parameter sets, selection which parameter set should be optimized is required ((**POpt**=1...6). If necessary, these settings must be made available when creating the engineering).
- Switch the controller to manual mode (key ). Alter the correcting variable to reach the working point.

The process must be in a stable condition. Self-tuning starts only, when process value oscillations are smaller than 0.5% of the control range during one minute (controller display: „process at rest’ (PiR)).

 If necessary, other control loops in the plant must be set to manual mode as well.



Set-point reserve:

To permit self-tuning, the distance between setpoint and process value must be higher than 10% of the setpoint range before self-tuning start.

With inverse controllers, the set-point must be higher than the process value. With direct controllers, it must be smaller.

The set-point determines a limit which is not exceeded during self-tuning.

Self-tuning start

Select function **Stat: OFF/OK** and confirm it with . **Stat: OFF/OK** blinks and is switched over to **Stat: Start** by pressing .

Pressing key  starts the self-tuning attempt. The set-point can be changed also subsequently. After successful self-tuning, the controller changes to automatic operation and controls the set-point with the new parameters.

Fig.: 18 Self-tuning with heating and cooling

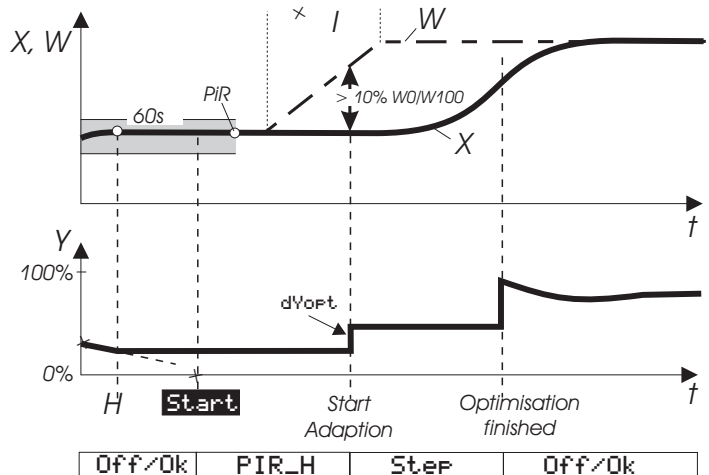
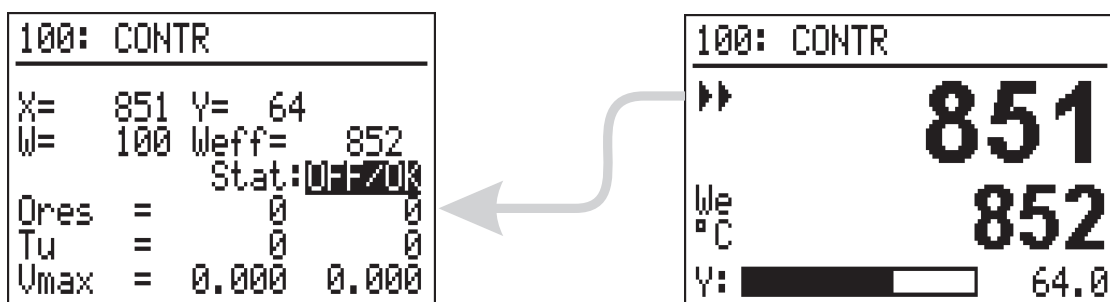

Fig. Calling up the self-tuning page



When self-tuning is finished with an error (**Ada_Err** or **OErr** on the controller page), the initial correcting variable is output until self-tuning is finished by pressing key H.

Self-tuning procedure with heating and cooling processes:

(3-point / split-range controller)

Self-tuning starts as with a "heating" process. After self-tuning end, the controller settings based on the calculated parameters are made. This is followed by line-out at the pre-defined set-point, until PiR is reached again.

Subsequently, a step to cooling is made to determine the "cooling" parameters. When cancelling the cooling attempt, the parameters for "heating" are also taken over for cooling. No error message (**Ada_Err**) is output.

⚠ Whilst self-tuning is active, the control function is switched off!

Fig.: 19

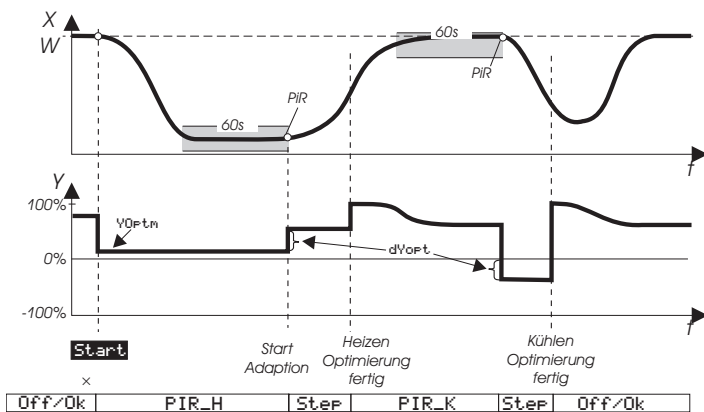

The self-tuning statuses are indicated with priority in the display field for manual operation.

- Self-tuning running, display: ORun
- Self-tuning faulty, display: OErr

Self-tuning completed with an error is finished by pressing key **H** twice.

Self-tuning cancelation

Fig.: Controller page with started self tuning

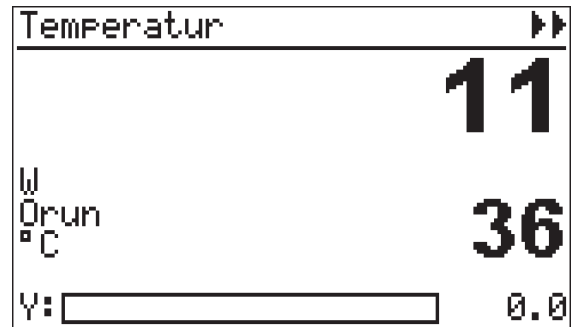

Self-tuning can be stopped at any time by pressing key **H**, or by selecting Stop in the Stat field (status).

When 'Process at rest' (**PiR**) is detected and a sufficient set-point reserve is provided, the correcting variable is changed by output step (boosted with indirect controller, lowered with direct controller).

! The size of the output step change is set to 100% as standard. In critical processes, this value (parameter **dYopt**) may have to be reduced to prevent damage to the process. The parameter is adjustable in the engineering, or via the parameter dialogue of the main menu, if the engineering is known. In case of doubt, contact the programming engineer.

Signification of self-tuning messages ORes1/ORes2

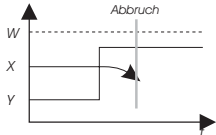
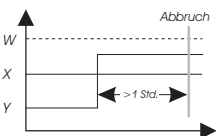
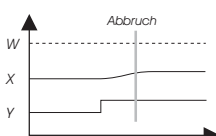
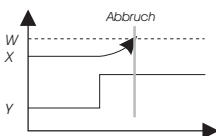
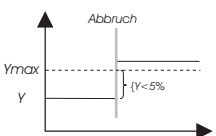
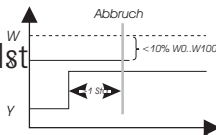
ORes1/2	Signification or trouble cause	Possible solution
0	No attempt was made or attempt cancelled by Stat: STOP or switchover to manual mode ( key) .	
1	Cancellation: Faulty correcting variable output action, X does not change in the direction of W.	 Change controller output action.
2	Finished: self-tuning was completed successfully (reversal point found, safe estimation)	
3	Cancellation: The process does not respond or responds too slowly (change of ΔX smaller than 1% in 1 hour)	 Close control loop.
4	Completed, without AdaErr: Successful attempt, process has a low reversal point	Optimum result with low reversal point
4	Cancellation, with AdaErr: Attempt failed, process stimulation low (Reversal point found, but estimation is unsafe)	 Increase output step change dYopt .
5	Cancellation: Self-tuning cancelled because of exceeded set-point hazard.	 Increase separation of process value (X) and set-point (W) when starting, or decrease YOptm .
6	Completed: attempt successful, but self-tuning cancelled due to exceeded set-point hazard. (Reversal point not reached so far; safe estimation).	
7	Cancellation: Output step change too small, $\Delta Y < 5\%$.	 Increase Ymax or set YOptm to a smaller value.
8	Cancellation: Set-point reserve too small, or exceeded set-point whilst PiR monitoring is busy.	 Vary stable correcting variable YOptm .

A special controller type offers the following self-tuning page.

For self-tuning preparation, parameters must be adjusted dependent on process and engineering.

Fig. Optimierungsseite

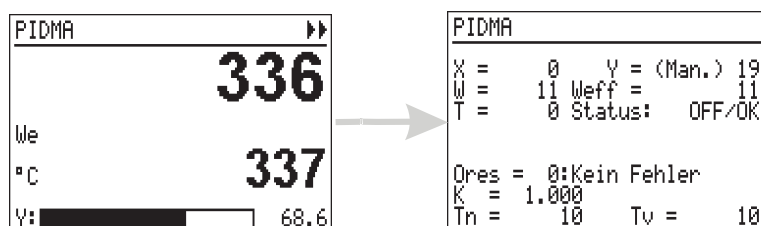

For this purpose, special knowledge of the applicable function block is required, i.e. it should be done by the programming engineer. Self-tuning start is as described above.

ORes	Signification or error cause	Possible solution
0	No attempt was made	
1	Xlimit too small	Step change threshold too small: compared to the process noise, the step change threshold is too small. Start a new attempt with a higher positioning pulse.
2	dYopt too high	Positioning pulse too high: the correcting variable would exceed the positioning limits when the selected pulse height is output. Start a new attempt with smaller positioning pulse or reduce the correcting variable in manual mode previously.
3	Re-start	No rest. The autotuner has detected that the process is probably not at rest. Please wait, until reaching the rest condition. Another possibility is to activate the drift compensation or to increase the positioning pulse. Note: With pulse width modulated (PWM) control outputs (2 and 3-point controller), oscillations of process value PV are susceptible to occur even during manual mode, if the corresponding cycle time t1 (t2) is too long. In this case, the controller cycle times should be as low as possible.
4	dYopt small	Positioning pulse too small: the step response is hidden by process noise. Start a new attempt with a higher positioning pulse, or take measures to reduce the noise (e.g. filter).
5	No extreme	Max. detection failed: after output of the positioning pulse, no maximum / minimum in the process value curve was detected. The settings for the process type (with / without compensation) should be checked.
6	Positioning limit	Positioning limits during self-tuning were exceeded. During the attempt, correcting variable MV has exceeded the positioning limits. Repeat the attempt using a smaller positioning pulse or a reduced correcting variable during manual mode.
7	Controller type	No self-tuning result for the specified combination P/I/D can be found.
8	Monotony	Process not monotonous: the process has a strong all-pass behaviour (temporarily, the process value runs in opposite direction) or serious trouble during the attempt.
9	Estimation error	Extrapolation failed: after the positioning pulse end, no process value decrease was detected because of excessive noise. Increase the positioning pulse or attenuate the noise.
10	No result	Result useless: excessive noise, or the determined process parameters do not correspond to the description of a process with dead band. Start a new attempt with a higher positioning pulse or attenuate the noise.
11	Man. cancelation	The self-tuning attempt was canceled manually by the operator with „STOP“ .
12	Output action	Faulty output action: the expected output action of the step response is opposed to the correcting variable. Cause can be faulty setting of the output action, or e.g. inverting actuators. Change the controller output action.

11.7 Cascade controller

With cascade control, two coupled controllers act on a common actuator. A process value for the master and a process value for the slave controller are required.

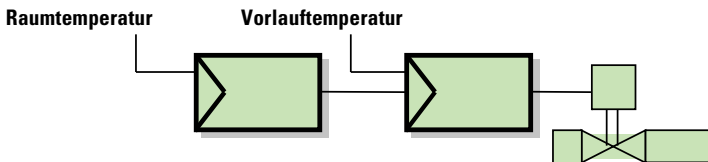

The slave set-point is determined via the external set-point by the master.

Cascade operation is possible in the following statuses:

Automatic mode

In a cascade, master and slave operate automatically during automatic mode.

The master set-point and process value are the relevant variables for process control.

The master set-point is adjustable.

The slave set-point ⑤ is displayed additionally.

 **"Cascade"** is displayed.

Fig. Operating page of a cascade controller in automatic

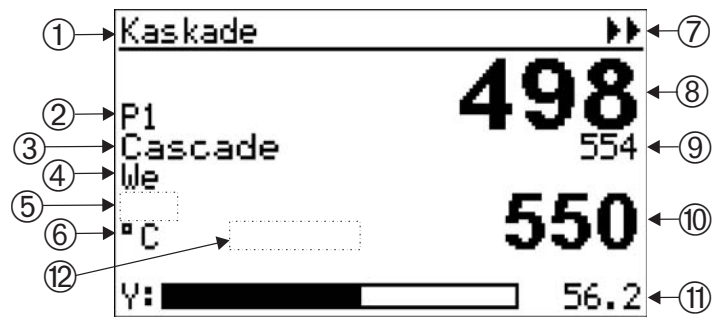

- ① Operating page title
- ② Parameter set selection, if available
- ③ Switchover field cascade mode (open/closed)
- ④ Set-point source of master (W_{int} , W_{ext} , W_2)
- ⑤ Display field for manual mode (otherwise empty)
- ⑥ Physical unit (master block parameter)
- ⑦ Entry into self-tuning
- ⑧ Master process value
- ⑨ Slave process value
- ⑩ Set-point (from master in automatic mode, from slave with open cascade)
- ⑪ Bargraph and display (Y from slave or X/XW from master)
- ⑫ Display of slave selection with open cascade (otherwise empty)

Cascade opened

For opening the cascade and control by means of the slave controller (see note text "Slave" on the operating page), switchover field ③ is switched to "Casc- Open".

 "Casc-open" is displayed.

Fig. Cascade controller with open cascade



The slave set-point is displayed now.

Now, the slave controller set-point becomes the variable used for process control and can be adjusted.

The process value of the master control loop is set by the cascade loop rather than being controlled. Switchover between set-point operation by master or slave is always possible.

In cascade mode, the master information is displayed in the fields for set-point, set-point source, physical unit and X/XW bargraph. With open cascade (display "Slave"), the slave information is displayed.

Manual mode

Switchover to manual is via key H (display in field ⑤). The cascade status (open/closed) is not affected.

In manual mode the process is controlled directly with the slave correcting variable.

The slave correcting variable can be adjusted during manual operation.

 "Man" is displayed.

Fig. Cascade controller in manual mode

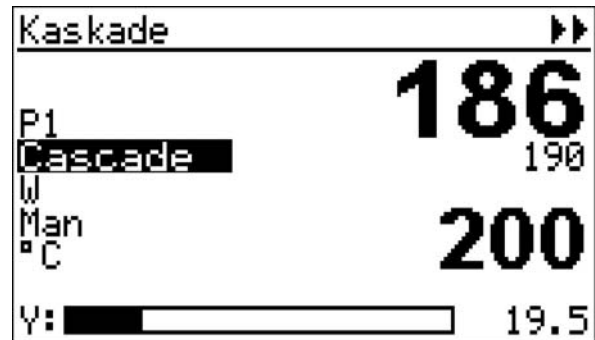

Cascade optimization

In a cascade, the slave controller and then the master must be optimized.

The self-tuning entry of the cascade operating page  relates always to the slave!

 For optimizing, the master must be selected purposefully via the operating menu. For this, the project description must be used.

12. Maintenance, test, trouble shooting

12.1 Cleaning

Housing and front panel can be cleaned using a dry, lint-free cloth. No use of solvents or cleansing agents!



Avoid using solvents or cleansing agents!

12.2 Behaviour in case of trouble

The unit needs no maintenance. In case of trouble, check:

- Is the unit in on-line mode ?
- Is the supply voltage connected correctly? Are voltage and frequency within the tolerances?
- Were all connections made correctly ?
- Do the sensors and actuators work properly?
- Is the engineering OK?
- Is the unit configured for the required operating principle?
- Do the adjusted parameters have the required effect?
- Are the I/O extension modules plugged in and clicked in position correctly (modular option C)?
- Is a terminating resistor activated (can be required dependent on the instrument position in the bus topology with CANopen and PROFIBUS DP)?
- Were the required EMC measures carried out (screened cables, earthings, protective circuits, etc.)?
- Does the diagnostic page of the test engineering indicate an error?

If the unit does not function correctly after these checks, it must be shut down and replaced. A defective unit can be returned to the supplier for repair.

12.3 Shut-down



Disconnect the supply voltage completely and protect the unit against accidental operation. As the instrument is mostly connected with other facilities in the control loop, consider the effects before switching off and take measures to prevent the occurrence of undesired operating conditions!

12.4 Test engineering as basic

KS98-1 is factory set for a test engineering **IO-test.edg**, which ensures checking of the possible inputs and outputs of the extended basic unit (standard + option B + option C). If KS98-1 is provided with a customer-specific engineering, the relevant description is applicable.



If KS98-1 is provided with customer-specific engineering, the engineering description is applicable.

A diagnostic page is provided to indicate *system errors* in case of start-up problems. The availability of the real-time clock is also displayed.

The display colour can be changed green/red and normal/inverse.

Menustructure of the test-engineering

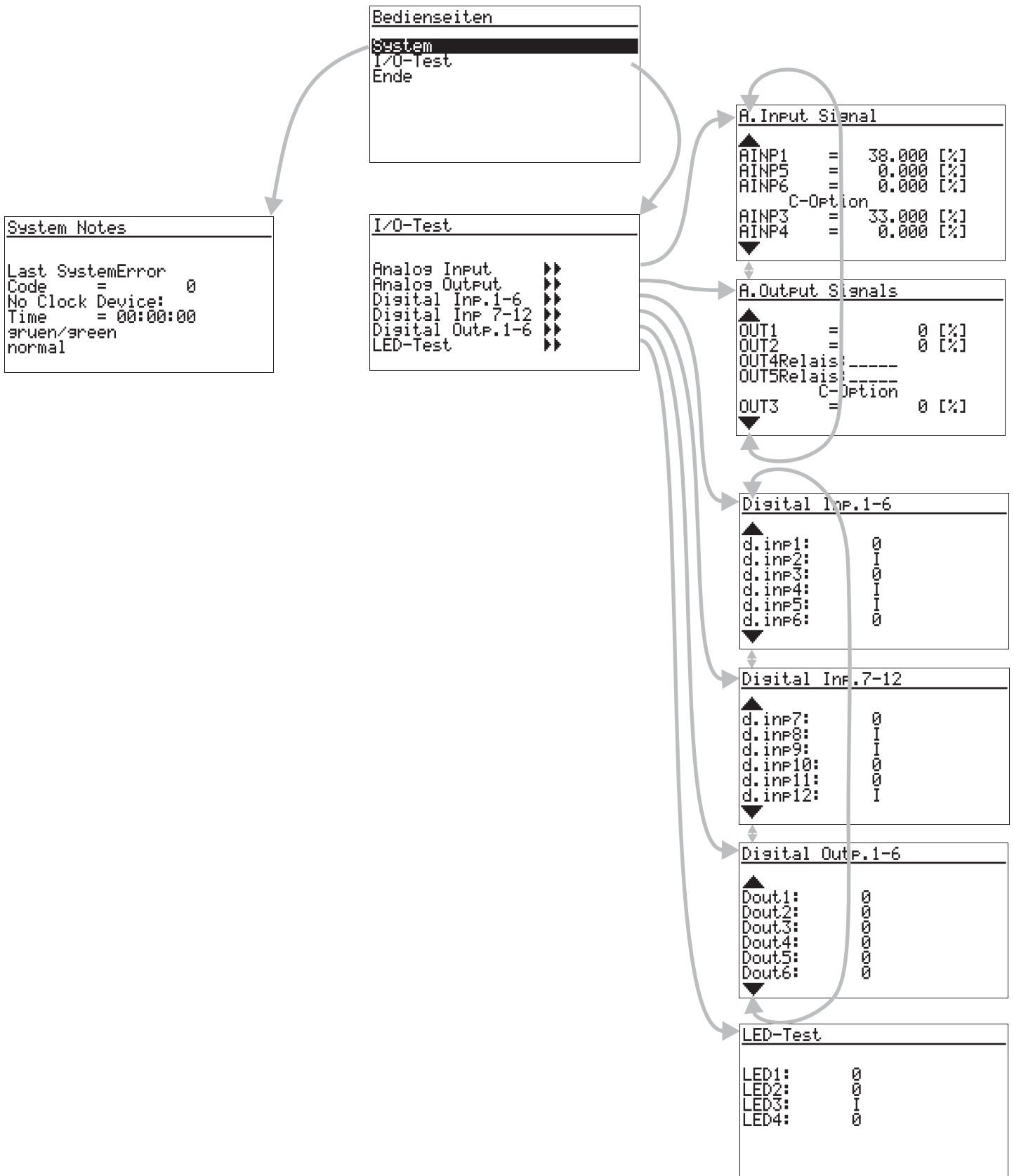

12.5 I/O-Test

Input and output type and measuring/signal range are configurable.

For this, switch the unit to OFFLINE(→ page 32) first after starting up. All inputs and outputs are preset to 0 .. 20mA and 0-100% value range.

Before commissioning, the inputs and outputs to be connected must be configured for the required sensor type via main menu "Configuration".

 After adjusting the correct type, the unit must be switched back to ONLINE!





Now, KS98-1 is ready for the first input/output test. Possible settings:

- AINP1: thermocouple types; Pt100; 2*Pt100; 0/4 .. 20mA; 0/2 .. 10V; transducer 500Ω; resistance 500Ω 250Ω
- AINP3 (option C): 0/4 .. 20mA
- AINP4 (option C): 0/4 .. 20mA
- AINP5 : 0/4 .. 20mA
- AINP6 : 0/4 .. 20mA
- OUT1 : 0/4 .. 20mA or relay
- OUT2 : 0/4 .. 20mA or relay
- OUT3 (option C) : 0/4 .. 20mA
- OUT4 : relay
- OUT5 : relay

Dependent on instrument selection, outputs OUT1 and OUT2 can be relay or current output. Accordingly, they must be controlled digitally or analogously in the engineering.

As all outputs were defined as analog outputs in the present engineering, a value below 50% (corresponds to logic "0") and a value above 50% (corresponds to logic "1") must be set for relay output testing.

Outputs OUT4 and OUT5 are always relays, i.e. they are controlled digitally on the relevant operating page. (Adjusting values → Navigation page 29).

Adjusting the output values and selecting the pages are done as described. Continuation pages are selected using keys   via the menu lines (, ) and called up with .

 This engineering is not suitable for controlling a plant. For this purpose, a customer-specific engineering is required (see versions, section: Adjustment on page 16).



Faulty settings can cause damage to instrument and plant!

